



LRT Design Criteria



THIS DOCUMENT WAS THE CURRENT REVISION WHEN ISSUED IN HARD COPY, CHECK THE ELECTRONIC FILE ON THE SANDAG WEBSITE TO ASSURE YOU HAVE THE CURRENT REVISION PRIOR TO USE.

THIS PAGE INTENTIONALLY LEFT BLANK

LRT Design Criteria Manual

Rev0 March 14, 2014

Prepared by:
The San Diego Association of Governments (SANDAG)



This Manual is published as a set of general guidelines for the planning and design of list rail transit (LRT) extensions and improvements. While this Manual is comprehensive, it is not meant to replace the standard design process. Project design is still the responsibility of the designer.

The intent of the Manual is to establish general criteria for project design. However, deviations are anticipated from time to time. The Director of Rail must approve any such changes or deviations.



John Haggerty
Director of Rail

3/14/2014

Date

**REVISION RECORD
LRT DESIGN CRITERIA MANUAL**

REV. NO	REV. DATE	SECTION (S) AFFECTED	COMMENTS
0	3/14/14	All	Initial Issue

Table of Contents

1.0	SPECIAL CIVIL WORK FOR LRT	1-1
1.1	Drainage	1-1
1.1.1	Project Hydrology	1-1
1.1.2	Drainage Discharge in Trackway	1-1
1.1.2.1	Ballasted Track	1-1
1.1.2.2	Grade Crossings	1-2
1.2	Utilities for LRT	1-2
1.2.1	Traction Power Requirements	1-2
1.2.2	Design Requirements for Underground Utilities	1-2
1.2.3	Risk Assessment	1-2
1.3	Right-of-Way Requirements for LRT	1-2
1.3.1	At-Grade Construction	1-2
1.3.1.1	General	1-2
1.3.1.2	Height Limits	1-3
1.3.1.3	Lateral Limits	1-3
1.3.2	Aerial Construction	1-3
1.3.3	Drainage and Utility Easements	1-3
1.3.4	Traction Power Substations	1-3
1.3.5	Right-of-Way Safety	1-4
1.3.5.1	Access	1-4
1.3.5.2	Means of Egress	1-4
2.0	LRT STATIONS	2-1
2.1	Site Layout	2-1
2.1.1	Platform General Circulation and Access	2-1
2.1.2	Bus and Parking Circulation Access	2-1
2.2	Service Access	2-2
2.3	Platform Geometry	2-2
2.3.1	Platform Length	2-2
2.3.2	Platform Height	2-2
2.3.3	Platform Width	2-2
2.3.4	Grade	2-3
2.4	Station Amenities	2-5

2.4.1	Shelters.....	2-5
2.4.2	Public Information Communications	2-5
2.4.2.1	Signs - General.....	2-5
2.4.2.2	Signs - Track ID	2-7
2.4.2.3	Station Identification Signs	2-7
2.4.2.4	Tactile Signs	2-7
2.4.2.5	Fare Paid Zone Signs	2-7
2.4.2.6	Advance Station Signs	2-7
2.4.2.7	Miscellaneous Directional Signs.....	2-7
2.4.2.8	Variable Messaging System (See Section 6.9) and Public Address (See Section 6.8).....	2-7
2.4.2.9	Transit Next Bus Messaging System (TNBMS)	2-7
2.4.2.10	Information Sign Frames.....	2-7
2.5	Fare Collection (See Fare Collection Technology, Section 6.10).....	2-8
2.6	Station System (See Communications, Chapter 6.0)	2-8
2.7	Electrical	2-8
2.7.1	General	2-8
2.7.2	Electrical Service.....	2-8
2.7.3	Electrical Distribution System	2-9
2.7.3.1	Panelboards.....	2-10
2.7.3.2	Circuit Breakers	2-10
2.7.3.3	Conduits.....	2-10
2.7.3.4	Pull Boxes	2-10
2.7.3.5	Conductors and Cables.....	2-11
2.7.3.6	Miscellaneous Electrical Equipment.....	2-11
2.7.4	Grounding	2-11
2.7.5	Lighting	2-12
2.7.5.1	General.....	2-12
2.7.5.2	Contactors and Controls	2-12
2.7.6	Utilization Voltages.....	2-12
2.8	Ventilation for Subterranean Station	2-13
2.9	Fire Protection, Alarm, and Emergency Management Systems.....	2-13
2.10	Fire/Life Safety (Elevated or Underground Station)	2-15

3.0	TRACKWORK	3-1
3.1	Alignment and Clearance.....	3-1
3.1.1	General	3-1
3.1.1.1	Alignment.....	3-1
3.1.1.2	Clearance	3-2
3.1.2	Horizontal Alignment	3-2
3.1.2.1	Horizontal Clearances.....	3-2
3.1.2.2	Minimum Clearances	3-2
3.1.2.3	Standard Clearances	3-2
3.1.2.4	Adjustments	3-5
3.1.2.5	Emergency Walkways.....	3-5
3.1.3	Tangent Alignment	3-6
3.1.4	Curved Alignment.....	3-6
3.1.4.1	Circular Curves	3-6
3.1.4.2	Minimum Radii	3-9
3.1.4.3	Minimum Length of Circular Curve.....	3-9
3.1.4.4	Spiral Transition Curves.....	3-9
3.1.4.5	Minimum Length	3-9
3.1.4.6	Curves without Spirals	3-10
3.1.4.7	Compound Circular Curves	3-10
3.1.4.8	Superelevation	3-12
3.1.5	Vertical Alignment	3-13
3.1.6	Vertical Grade	3-14
3.1.6.1	Grade Rates and Lengths	3-14
3.1.6.2	Mainline	3-14
3.1.6.3	Stations.....	3-14
3.1.6.4	Yard and Secondary Tracks.....	3-14
3.1.7	Vertical Curve.....	3-15
3.1.7.1	Mainline	3-15
3.1.7.2	Ride Quality	3-15
3.1.7.3	Stations.....	3-15
3.1.7.4	Compound Vertical Curves	3-15
3.1.7.5	Combined Vertical and Horizontal Curves.....	3-16

3.1.8	Vertical Clearance	3-16
3.1.9	Joint LRT/Freight Rail Corridor	3-16
3.1.9.1	Freight Clearance	3-16
3.1.9.2	Freight Loading	3-16
3.1.9.3	Temporal Separation.....	3-16
3.1.9.4	State of California	3-16
3.2	Mainline Track	3-18
3.2.1	Subgrade.....	3-18
3.2.2	Geotextile Fabrics	3-19
3.2.3	Sub-Ballast.....	3-19
3.2.4	Ballast	3-20
3.2.5	Corrosion.....	3-20
3.2.5.1	Standard Stray Current Corrosion Control.....	3-21
3.2.6	Concrete Cross Ties.....	3-21
3.2.7	Timber Cross Ties	3-22
3.2.8	Rail.....	3-23
3.2.8.1	Running Rail	3-23
3.2.8.2	High Strength Rail.....	3-23
3.2.8.3	Restraining Rail.....	3-23
3.2.9	Rail Welding and Joints	3-24
3.2.9.1	Continuous Welded Rail.....	3-24
3.2.9.2	Bolted (Non-Welded) Rail Joints	3-25
3.2.10	Emergency Guardrail.....	3-25
3.2.11	Rail Seats and Fasteners	3-25
3.2.11.1	Timber Crossties.....	3-25
3.2.11.2	Concrete Crossties.....	3-26
3.2.11.3	Direct Fixation	3-26
3.2.12	Track Access.....	3-27
3.2.13	Noise and Vibration	3-28
3.3	Special Trackwork.....	3-28
3.4	Other than Mainline Track.....	3-29
3.4.1	Yard Track.....	3-29
3.4.1.1	Ballast	3-29

3.4.1.2	Cross Ties.....	3-30
3.4.1.3	Rail	3-30
3.4.1.4	Restraining Rail.....	3-30
3.4.1.5	Rail Joints	3-30
3.4.1.6	Special Trackwork.....	3-30
3.4.1.7	Paved Trackwork	3-30
3.4.2	Shop Trackwork	3-31
3.4.3	Bumping Posts	3-31
3.5	Highway-Railway Crossings.....	3-31
3.5.1	PUC Requirements	3-32
4.0	TRACTION POWER	4-1
4.1	Environmental Requirements.....	4-2
4.2	Applicable Documents	4-3
4.3	Standard Plans	4-3
4.4	Acceptance Testing and Measurements	4-3
4.4.1	Test Documents	4-4
4.4.2	Test Plan.....	4-4
4.4.3	Test Procedures.....	4-5
4.4.4	Test Reports.....	4-5
4.4.5	Field Test Categories	4-5
4.5	Compatibility with the Existing Systems	4-6
4.6	Energized System.....	4-6
4.7	Technical Design Reports.....	4-6
4.8	System Design Requirements.....	4-7
4.8.1	Operational Criteria	4-7
4.8.2	Minimum Voltage Criteria	4-8
4.8.3	Criteria for Contingency Operations.....	4-8
4.8.4	Criteria for Light Rail Vehicle (LRV) Storage Facilities	4-8
4.8.5	Load Flow Analysis of the Traction Electrification System (TES)	4-8
4.8.6	Stray Current Mitigation.....	4-9
4.8.7	Traction Power System Supervisory Control and Data Acquisition	4-10
4.8.8	Transfer Trip System.....	4-11
4.9	Traction Power Substations	4-11

4.9.1	Substation Site Selection.....	4-11
4.9.2	Substation Site Requirements	4-12
4.9.2.1	Substation Grounding Requirements.....	4-13
4.9.2.2	Concrete Slab Foundation and Fencing	4-14
4.9.2.3	Utility Power Supply	4-14
4.9.2.4	Substation Site Conduits	4-15
4.9.2.5	Visibility Requirement.....	4-16
4.9.3	Yard and Shop Substations	4-16
4.9.4	Setting the Substation On-Site	4-16
4.9.5	Terminations of Exterior Equipment.....	4-16
4.9.6	House Power.....	4-16
4.9.7	SCADA.....	4-17
4.9.8	Traction Power Substations.....	4-17
4.9.8.1	Mode of Operation and Design.....	4-17
4.9.8.2	Stray Current Drainage Facilities.....	4-17
4.9.8.3	DC Surge Arresters.....	4-17
4.9.9	Negative Grounding System Protection	4-17
4.10	DC Distribution System.....	4-18
4.10.1	Yard and Shop Traction Power Facilities	4-21
4.10.2	Raceways.....	4-21
4.10.3	Positive Feeder System.....	4-22
4.10.4	Negative Distribution System.....	4-24
4.11	Overhead Contact System	4-25
4.11.1	General	4-25
4.11.1.1	OCS Limits.....	4-25
4.11.1.2	OCS Electrical Requirements.....	4-25
4.11.1.3	Minimum Resistance-To-Earth Requirements	4-25
4.11.1.4	OCS Crossover Requirements.....	4-25
4.11.1.5	OCS Overlap Requirements.....	4-25
4.11.1.6	Length of Tension Sections for Auto Tension Catenary.....	4-26
4.11.1.7	Separation from Aerial Utilities	4-26
4.11.2	Support System.....	4-26
4.11.2.1	Pole and Down-Guy Foundations.....	4-27

4.11.2.2	Foundation Design.....	4-27
4.11.2.3	Elevation of Pole Foundations.....	4-27
4.11.2.4	Poles and Moment Resisting Frames.....	4-27
4.11.2.5	Pole and Frame Description.....	4-28
4.11.2.6	Grounding of Poles and Frames.....	4-28
4.11.2.7	Location of Poles and Frames.....	4-28
4.11.2.8	Cantilever Supports.....	4-29
4.11.2.9	Head-Spans.....	4-29
4.11.2.10	Down-Guys.....	4-29
4.11.3	Catenary Suspension.....	4-29
4.11.3.1	Selection of Catenary Suspension System.....	4-29
4.11.3.2	CPUC Requirements.....	4-30
4.11.3.3	Catenary Conductors Requirements.....	4-30
4.11.3.4	Pantographs.....	4-31
4.11.3.5	Clearance Envelopes and Wire Stagger.....	4-31
4.11.3.6	Contact Wire Heights.....	4-32
4.11.3.7	Contact Wire Profiling.....	4-32
4.11.3.8	Messenger Wire Heights.....	4-33
4.11.3.9	Design Span Lengths.....	4-34
4.11.3.10	Design Tensions for Auto-Tension (AT) Catenary.....	4-35
4.11.3.11	Design Tensions for Fixed-Tension (FT) Catenary.....	4-35
4.11.3.12	Tensioning Methods.....	4-35
4.11.3.13	Lightning Arrestor Assemblies.....	4-36
4.11.3.14	Midpoint Anchors.....	4-36
4.11.3.15	Wire Cross Assemblies.....	4-36
4.11.3.16	Additional Requirements for Full and Low Profile Catenary.....	4-36
4.11.3.17	Additional Requirements for Tunnel Catenary.....	4-37
4.12	Stray Current/ Reduction Methods.....	4-37
4.12.1	Stray Current Reduction.....	4-37
4.13	Atmospheric Corrosion Control.....	4-37
4.13.1.1	General.....	4-37
4.13.1.2	Traction Power Substation Enclosures.....	4-37

5.0	RAILWAY SIGNALING AND INDICATION SYSTEMS.....	5-1
5.1	General.....	5-1
5.1.1	Environmental	5-1
5.1.2	Acceptance Testing and Measurements.....	5-2
5.1.2.1	Test Documents.....	5-2
5.1.2.2	Test Plan.....	5-2
5.1.2.3	Test Procedures.....	5-3
5.1.2.4	Test Reports	5-3
5.1.2.5	Test Categories.....	5-3
5.1.2.6	Compatibility with the Existing Systems	5-4
5.2	Non Signalized Right-of-Way	5-4
5.2.1	Trolley and Traffic Signal Interface	5-4
5.2.2	Switch Controls and Indications.....	5-5
5.3	Railway Signaling in Semi-Exclusive or Exclusive Right-of-Way	5-6
5.3.1	General	5-6
5.3.1.1	Applicable Documents	5-6
5.3.1.2	Fail-safe Design	5-7
5.3.1.3	Failure Modes	5-7
5.3.1.4	Equipment Failures and Conditions.....	5-8
5.3.1.5	Drawings, and Manuals, and Training Requirements	5-8
5.3.1.6	Operating Requirements	5-10
5.3.1.7	Electrical Compatibility	5-10
5.3.2	Block Signaling.....	5-10
5.3.2.1	Interlocked Control Circuits at Turnout Crossover and Double Crossovers.....	5-11
5.3.2.2	Requesting and Processing Routes	5-11
5.3.2.3	Non-Powered Turnout, Crossover, and Double Crossover	5-13
5.3.2.4	Restrictions to Block Control Logic.....	5-13
5.3.2.5	Clear Block	5-13
5.3.2.6	Wayside Signals	5-14
5.3.2.7	Permissive Block.....	5-14
5.3.2.8	Beginning and Ending ABS	5-14

5.3.2.9	Track Circuits	5-14
5.3.2.10	Raceway Requirements	5-15
5.3.2.11	Cabling Requirements.....	5-16
5.3.2.12	Relay Design.....	5-17
5.3.2.13	Electric Switch and Lock Movements for Mainline Switches	5-19
5.3.2.14	Electric Switch Locks with Point Detectors for Main Line Switches	5-20
5.3.2.15	Main Line Switch Stands and Targets	5-21
5.3.2.16	Equipment Enclosures	5-21
5.3.2.17	Push-Button Control Stands.....	5-22
5.3.2.18	Programmable Logic Controllers	5-22
5.3.2.19	Vital Logic Controllers	5-22
5.3.2.20	Event Recorders	5-23
5.3.2.21	Train-to-Wayside Communications (TWC)	5-24
5.3.2.22	Block and Interlocking Signal Numbering Requirements ...	5-24
5.3.2.23	Layout Design Requirements	5-25
5.3.3	Special Condition Indications.....	5-30
5.4	Grade Crossing Warning System.....	5-31
5.4.1	Circuit Design Requirements	5-33
5.4.2	Crossing Equipment Layout Design Requirements.....	5-35
5.4.3	Utilization of Existing Equipment	5-37
5.5	Power	5-37
5.6	Interface Requirements.....	5-37
5.6.1	General	5-37
5.6.2	Civil Facilities	5-37
5.6.3	Trackwork.....	5-38
5.6.4	Vehicles	5-38
5.6.5	Power	5-38
5.6.6	Traction Power Substations.....	5-38
5.6.7	OCS	5-38
5.6.8	Wide Area Network and Local Area Network.....	5-38
5.6.9	Traffic Signals	5-39

6.0	COMMUNICATIONS	6-1
6.1	General.....	6-2
6.1.1	Communications Systems Overview	6-3
6.1.1.1	Digital Communications	6-3
6.1.1.2	Vehicle to Wayside Wi-Fi Wireless Local Area Network Communications	6-4
6.1.1.3	Voice Radio Communication System	6-4
6.1.2	Definitions and Terms.....	6-5
6.1.3	Environment	6-8
6.1.4	Regulations, Codes, and Standards	6-10
6.1.5	Industry Standard Practices.....	6-11
6.1.6	Testing, Commissioning, and Acceptance Requirements	6-11
6.2	Operations Control Center	6-11
6.2.1	Operations Control Center - Centralized Train Control	6-11
6.2.2	Evaluation of OCC Facility Modifications Required to Support Territorial Expansion	6-12
6.2.3	Design Development of OCC Facility Modifications Required to Support Territorial Expansion	6-14
6.3	Station Communications Enclosures, Buildings, and Rooms	6-14
6.3.1	General	6-14
6.3.1.1	Grounding and Surge Suppression	6-14
6.3.1.2	Programmable Logic Controller.....	6-14
6.3.1.3	Locating Communications Cabinets or Buildings.....	6-15
6.3.1.4	Communications Cabinet, Building and Room Foundations.....	6-15
6.3.2	Communications Cabinet, Building and Room at Standard Stations... ..	6-16
6.3.2.1	Communications Cabinet - Three Bay Communications Enclosure	6-16
6.3.2.2	Communications Enclosure - Prefabricated Communications Building.....	6-20
6.3.2.3	Communications Room.....	6-28
6.3.3	Communications Enclosures at Enclosed or Non-Standard Stations.. ..	6-35
6.4	Wide Area Network Communications.....	6-35
6.4.1	Network Architecture	6-35
6.4.1.1	Vital Wide Area Network	6-36

6.4.1.2	Non-Vital WAN.....	6-36
6.4.2	WAN SMF Cabling	6-37
6.4.3	WAN Modifications and Equipment Procurement and Installation	6-38
6.4.4	WAN Design.....	6-39
6.5	Local Area Network Communications	6-39
6.5.1	Network Architecture	6-39
6.5.2	LAN Ethernet Cables.....	6-39
6.5.3	LAN SMF Cabling.....	6-39
6.5.4	Cable Tags.....	6-40
6.5.5	LAN Design.....	6-41
6.6	Cabling Raceways and Access Points	6-41
6.6.1	Cabling Raceways Paralleling the Trackway Except Under Stations ..	6-41
6.6.1.1	Riser Pole Raceways	6-42
6.6.1.2	Cable Tray Raceways	6-42
6.6.1.3	Underground Conduit Raceways.....	6-43
6.6.1.4	Railway Signaling Communications and Power Cabling Through Stations.....	6-43
6.6.1.5	Station Non-vital WAN and LAN Raceway System.....	6-43
6.6.2	Raceway Materials and Installation	6-45
6.6.3	Access Points.....	6-48
6.7	Network Cabling Standard	6-48
6.8	Public Address.....	6-49
6.8.1	General Description.....	6-49
6.8.2	Noise Assessments	6-50
6.8.3	Layout and Standards	6-50
6.8.4	Technical and Performance Characteristics	6-51
6.8.5	Stations in Enclosed Structures.....	6-52
6.8.5.1	Supervision and Alarms	6-52
6.8.5.2	Enclosed Station System Input Priorities.....	6-52
6.8.6	Operation Control Center Remote Access.....	6-52
6.8.7	Ethernet Connection in Enclosed Station.....	6-53
6.8.8	Connection to Cabling to Amplifier in Enclosed Station	6-53
6.8.9	Connection to Cabling to Speakers in Enclosed Station	6-53

6.9	Visual Messaging System	6-53
6.9.1	General	6-53
6.9.2	Description	6-54
6.9.3	Location VMS Signs, Frames, and Foundations	6-54
6.9.4	Communications Provisions	6-55
6.9.5	Electrical Provisions	6-56
6.9.6	Raceways and Pullboxes	6-56
6.9.7	VMS Messaging	6-56
6.10	Fare Collection Technology	6-57
6.10.1	General	6-57
6.10.2	Locating Ticket Vending Machines and Passenger Card Interface Devices.....	6-57
6.10.3	Ticket Vending Machine Equipment Pads and Connections	6-58
6.10.4	Passenger Card Interface Device Connections	6-58
6.10.5	Permanent Ticket Kiosks and Portable Ticket Trailers.....	6-59
6.11	Traction Power System SCADA.....	6-60
6.12	Signaling System SCADA.....	6-60
6.13	Bi-Directional Train to Wayside Communications.....	6-60
6.13.1	General	6-60
6.13.2	Equipment Compatibility.....	6-61
6.13.3	TWC Loop Antenna and Loop Converter.....	6-61
6.13.4	Interrogators.....	6-61
6.13.5	Communications Card.....	6-62
6.13.6	Serial Output/Input Card.....	6-62
6.14	Electrical Grounding and Power Surge Protection.....	6-62
6.15	Uninterruptible Power System and Power Generation Facilities	6-64
6.15.1	Topology	6-65
6.15.2	Batteries.....	6-65
6.15.3	Voltages	6-65
6.15.4	Battery Charging	6-65
6.16	Temperature Sensing, Intrusion Detection, and TWC Processing System	6-65
6.17	Bicycle Locker Networking Provisions.....	6-66
6.18	Axel Counters	6-66

6.19	Vehicle to Wayside Wi-Fi Wireless Local Network Communications	6-66
6.20	Voice Radio Communication System	6-66
6.20.1	RCS Upgrades to Accommodate New Territory.....	6-67
6.20.2	Existing RCS Frequencies.....	6-68
6.20.3	Additional Radio Frequencies.....	6-69
6.20.4	Transmitters	6-69
6.20.5	Receivers	6-69
6.20.6	Portable Radios.....	6-70
6.20.7	Mobile Radios	6-70
6.20.8	Operation Control Center	6-70
6.21	Video Surveillance Systems.....	6-70
6.22	Phone Service Provisions and Public Pay Phones.....	6-73
6.22.1	Payphone Services	6-73
6.22.2	Elevator Emergency Phone	6-74
6.22.3	Phone Company Interface.....	6-74
6.23	Electromagnetic Compatibility	6-74
6.24	Fixed Double Sided Information Signs	6-75
6.25	Transit Next Bus Messaging System (TNBMS).....	6-75
6.26	Interactive Kiosks.....	6-75
6.27	Enclosed Stations within Structures	6-75
6.27.1	Fire Detection Systems	6-76
6.27.2	Fire Alarms and Emergency Response and Management Systems ...	6-76
7.0	VEHICLES	7-1
7.1	General.....	7-1
7.2	Operations	7-1
7.2.1	Operating Hours.....	7-1
7.2.2	Consists	7-1
7.2.3	Signaling System and Train to Wayside Communications	7-1
7.2.4	Train Speed.....	7-1
7.2.5	Annual Mileage.....	7-2
7.3	Vehicle Design Constraints	7-2
7.3.1	Safety Requirements.....	7-2
7.3.2	Weight Criteria.....	7-2

7.3.2.1	Weight Distribution	7-3
7.3.3	Vehicle Identification	7-3
7.3.4	Wayside Noise Control/Criteria.....	7-3
7.3.5	Electrical Noise Control Requirements	7-3
7.3.5.1	Radio Frequency Interference Limits.....	7-4
7.3.5.2	Electromagnetic Interference	7-4
7.3.5.3	Conductive Emission Limits	7-4
7.3.6	Smoke and Flammability Requirements	7-4
7.3.7	Provisions for Individuals with Disabilities.....	7-4
7.4	Vehicle Clearances	7-5
7.5	Vehicle Dimensions	7-5
7.6	LRV Loading (lbs)	7-9
7.7	Electrical	7-10
7.8	Vehicle Performance.....	7-10
7.8.1	Acceleration Requirements.....	7-11
7.8.2	Speed Requirements.....	7-11
7.8.3	Deceleration Requirements	7-11
7.8.3.1	Service Brake.....	7-11
7.8.3.2	Emergency Brake	7-12
7.8.3.3	Parking Brake	7-13
7.8.4	Towing Requirements.....	7-13
7.8.5	Jerk Limit.....	7-13
7.8.6	Wheel Slip/Slide Protection	7-13
7.8.7	Load Weight System	7-14
7.8.8	Mode Change Dead Times.....	7-14
7.9	Car Body.....	7-15
7.9.1	Strength Requirements.....	7-15
7.9.2	Roof	7-15
7.9.3	Jacking and Hoisting Provisions	7-15
7.9.4	Wheelchair Accommodations	7-15
7.10	Couplers and Draft Gear	7-16
7.10.1	Mechanical Couplers	7-16
7.10.2	Draft Gears.....	7-16

7.10.3	Electrical Couplers	7-16
7.11	Operator's Cab	7-16
7.11.1	Operator's Console	7-16
7.11.2	Bypass and Cutout Switches	7-16
7.12	Passenger Doors	7-16
7.12.1	Normal Operation	7-17
7.12.2	Emergency Operation.....	7-17
7.13	Air Comfort System.....	7-17
7.14	Lighting System	7-17
7.14.1	Interior Lighting.....	7-18
7.14.2	Exterior Lighting	7-18
7.14.3	Emergency Lighting.....	7-18
7.15	Auxiliary Electrical Equipment.....	7-18
7.15.1	Power Collection	7-18
7.15.2	Auxiliary Power Supply	7-18
7.15.3	Low-Voltage DC Power Supply	7-19
7.15.4	Storage Battery	7-19
7.15.5	Emergency Loads	7-19
8.0	LRV MAINTENANCE FACILITIES.....	8-1
8.1	General.....	8-1
8.2	Design Codes and Standards	8-1
8.2.1	Building Code	8-1
8.2.2	Permitting	8-1
8.3	Basic Design Process	8-2
8.3.1	Basis of Design Statement	8-2
8.4	Yard and Shop Facilities	8-2
8.4.1	Daily Service	8-2
8.4.2	Running Repair	8-2
8.4.3	Heavy Repair	8-3
8.4.4	Yard Operations	8-3
8.4.5	Yard Layout.....	8-3
8.4.6	Lighting	8-4
8.4.6.1	Building Lighting.....	8-4

	8.4.6.2	Vehicle Storage Lighting	8-4
	8.4.6.3	Illumination Plan.....	8-4
8.5		Vehicle Storage	8-4
	8.5.1	General	8-4
	8.5.2	Storage Capacity.....	8-5
	8.5.3	Parking and Service Roads	8-5
8.6		Maintenance	8-5
	8.6.1	General	8-5
	8.6.2	Vehicle Maintenance	8-6
	8.6.2.1	General Criteria.....	8-6
	8.6.3	Machinery and Equipment.....	8-7
	8.6.4	Vehicle Cleaning Area.....	8-7
	8.6.4.1	Daily Interior Cleaning.....	8-7
	8.6.4.2	Heavy Interior Cleaning.....	8-7
	8.6.4.3	Exterior Vehicle Wash.....	8-8
	8.6.5	Maintenance Inspection.....	8-9
	8.6.5.1	Configuration of Floor and Workspace	8-9
	8.6.5.2	Utility Requirements	8-9
	8.6.5.3	Special Equipment	8-10
	8.6.5.4	Design Requirements.....	8-10
	8.6.6	Minor (Running) Repairs	8-10
	8.6.7	Major Repairs and Component Change Out.....	8-10
	8.6.7.1	Configuration of Floor and Work Space.....	8-10
	8.6.7.2	Utility Requirements	8-10
	8.6.7.3	Special Equipment	8-11
	8.6.7.4	Design Requirements.....	8-11
	8.6.8	Wheel Truing.....	8-11
	8.6.8.1	Configuration of Floor and Work Space.....	8-11
	8.6.8.2	Utility Requirements	8-11
	8.6.8.3	Special Equipment	8-12
	8.6.8.4	Design Requirements.....	8-12
	8.6.9	Vehicle Body Repairs	8-12
	8.6.9.1	Configuration of Work Area for Minor Damage Repairs.....	8-12

8.6.9.2	Utility Requirements	8-12
8.6.9.3	Special Equipment	8-12
8.6.9.4	Design Requirements.....	8-13
8.6.10	Vehicle Painting.....	8-13
8.6.10.1	Paint Booth	8-13
8.6.11	Vehicle Sanding	8-13
8.6.11.1	Configuration of Work Area	8-13
8.6.11.2	Utility Requirements	8-13
8.6.11.3	Special Equipment	8-13
8.6.11.4	Design Requirements.....	8-14
8.6.12	Material Storage	8-14
8.6.13	Central Maintenance, Operations and Administrative Areas	8-14
8.6.13.1	Shop Ancillary Areas.....	8-14
8.6.14	Building Support Facilities	8-15
8.6.14.1	Administrative Offices	8-15
8.6.14.2	Training/Conference Rooms	8-15
8.6.14.3	Utility Power Room.....	8-15
8.6.14.4	Personnel Facilities	8-15
8.6.14.5	Janitor Facilities	8-15
8.6.15	Central Maintenance and Operations Area.....	8-15
8.6.16	Central Control Area.....	8-16
8.6.17	Emergency System Requirements	8-16
8.6.17.1	Safety Systems	8-16
8.6.18	Utility Needs	8-16
8.6.19	Building Systems.....	8-16
8.6.20	Security	8-17

List of Figures

Figure 2-1. – Typical Station Dimensioning (Plan View)	2-4
Figure 2-2. – Typical Station Dimensioning (Section View)	2-5
Figure 2-3. – Typical Station Signage Configuration	2-6
Figure 2-4. – Typical Layout for Means of Egress (Elevated Structure Shown)	2-16
Figure 3-1. – Static and Dynamic Envelopes.....	3-4
Figure 3-2. – Circular/Spiral Functions and Abbreviations.....	3-7
Figure 3-3. – Compound Curves and Combining Spiral Formulas and Abbreviations.....	3-11
Figure 3-4. – Superelevation (E_a).....	3-13
Figure 3-5. – Typical Subgrade Configurations	3-19
Figure 3-6. – Typical Concrete Tie Configuration (Dimensions Vary)	3-22
Figure 3-7. – Restraining Rail Detail.....	3-24
Figure 3-8. – Typical Rail Fastener for Concrete Tie	3-26
Figure 4-1. – Typical Traction Power Substation Layout	4-13
Figure 4-2. – TPSS Single Line Diagram with 4 DC Breaker	4-19
Figure 7-1. – U2 and SD100 Vehicle Dimensions	7-6
Figure 7-2. – SD7 Vehicle Dimensions.....	7-7
Figure 7-3. – SD8 Vehicle Dimensions.....	7-8

List of Tables

Table 4-1. – Clearance Envelopes and Wire Stagger Requirements.....	4-31
Table 5-1. – Stopping Distance for LRV	5-28
Table 5-2. – Stopping Distance for Freight Train	5-29
Table 6-1. – Environmental Operating Range	6-9
Table 6-2. – Input Priorities	6-52
Table 6-3. – RCS Frequencies.....	6-68
Table 7-1. – Vehicle Identification and Numbering	7-3
Table 7-2. – Wayside Noise Control/Criteria	7-3

Terms and Abbreviations

The following acronyms, initialisms, and short forms are used in this report.

List of Terms	Acronyms
American Association of State Highway and Transportation Officials	AASHTO
Advanced Conceptual Engineering	ACE
Americans with Disabilities Act	ADA
Americans with Disabilities Act Accessibility Guidelines	ADAAG
Area of Potential Effect	APE
Advanced Planning Study	APS
California Department of Transportation	Caltrans
California Environmental Quality Act	CEQA
Conditional Letter of Map Revisions	CLMR
California Public Utilities Commission	CPUC
Design-Build	DB
Design-Bid-Build	DBB
Disadvantaged Business Enterprise	DBE
Environmental Assessment	EA
Environmental Consultant	EC
Environmental Protection Agency	EPA
Federal Emergency Management Agency	FEMA
Full Funding Grant Agreement	FFGA
Finding of No Significant Impact	FONSI
Federal Transit Administration	FTA
Interstate 5	I-5
Intergovernmental Agreement	IGA
Joint Use and Maintenance Agreement	JUMA
Housing and Urban Development	HUD
Leadership in Energy and Environmental Design	LEED
Letter of Invitation	LOI
Letter of Map Revisions	LOMR
Letter of No Prejudice	LONP
Los Angeles-San Diego-San Luis Obispo Rail Corridor	LOSSAN
Locally Preferred Alternative	LPA
Light Rail Transit	LRT
Master Cooperative Agreement	MCA
San Diego Metropolitan Transit System	MTS

Terms and Abbreviations (Continued)

List of Terms	Acronyms
Manual of Uniform Traffic Control Devices	MUTCD
North County Transit District	NCTD
National Environmental Policy Act	NEPA
National Highway Traffic Safety Administration	NHTSA
Notice of Availability	NOA
Notice of Intent	NOI
National Pollutant Discharge Elimination System	NPDES
Notice to Proceed	NTP
National Transportation Safety Board	NTSD
Overhead Contact System	OCS
Office of Equal Opportunity Programs	OEOP
Oversight Procedure	OP
Occupational Safety and Health Administration	OSHA
Old Town Transit Center	OTTC
Preliminary Engineering	PE
Professional Engineer	P.E
Preliminary Engineering/Environmental Consultant	PEC
Preliminary Hazard Analysis	PHA
Public Involvement Plan	PIP
Project Manager	PM
Project Management Consultant	PMC
Project Management Oversight Contractor	PMOC
Project Management Plan	PMP
Project Report	PR
Project Study Report	PSR
Project Working Group	PWG
Quality Assurance / Quality Control	QA/QC
Quality Management Plan	QMP
Quarterly Review Meeting	QRM
Risk and Contingency Management Plan	RCMP
Request for Proposal	RFP
Right-of-Way	ROW
Signals and Communications	S & C
San Diego Association of Governments	SANDAG

Terms and Abbreviations (Continued)

List of Terms	Acronyms
Small Business Enterprise	SBE
Standard Cost Categories	SCC
San Diego Gas and Electric	SDGE
San Diego and Imperial Valley Railroad	SD&IV
San Diego Transit Corporation	SDTC
San Diego Trolley Inc.	SDTI
Subsequent Environmental Impact Report	SEIR
Supplemental Environmental Impact Statement	SEIS
State Historic Preservation Office	SHPO
State Route 52	SR 52
System Safety Certification Plan	SSCP
Safety and Security Management Plan	SSMP
Safety and Security Officer	SSO
State Safety Oversight Agency Subsurface Utility Exploration	SSOA
Storm Water Management Plan	SWMP
Technical Advisory Committee	TAC
Temporary Construction Easement	TCE
Traction Electrification System	TES
Transportation Investment Generating Economic Recovery	TIGER
Traction Power	TP
Traction Power Sub station	TPSS
Threat and Vulnerability Analysis	TVA
Ticket Vending Machine	TVM
Utility Cooperative Agreement	UCO
University of California at San Diego	UCSD
Union Pacific Railroad	UPRR
United States Code	USC
United States Department of Transportation	USDOT
United States Green Building Council	USGBC
University Towne Centre	UTC
Veteran's Affairs	VA
Year of Expenditure	YOE

THIS PAGE INTENTIONALLY LEFT BLANK

1.0 SPECIAL CIVIL WORK FOR LRT

All civil work shall comply with the general design criteria given in Volume 1 of this manual as well as the following special criteria as it applies to LRT design:

1.1 Drainage

1.1.1 Project Hydrology

All design parameters shall comply with Volume 1, Project Hydrology.

1.1.2 Drainage Discharge in Trackway

All design parameters for drainage analysis shall comply with Volume 1 – Civil Work, “Drainage” Section.

1.1.2.1 Ballasted Track

In general, drainage for ballasted trackway shall be designed to provide, at a minimum, the following:

- Water and drainage onto the trackway shall be collected into a system designed to convey the water off the right-of-way into a natural or urban drainage system;
- Prevent standing water along the right-of-ways and prevent contamination of ballast;
- Be sized to accommodate water entering the right-of-way from new or existing slopes draining toward the tracks;
- Include facilities for collecting and diverting drainage into the trackway drainage system. Facilities shall include, but not be limited to, brow ditches on slopes, down drains, energy dissipaters, and detention/retention basins. Detention/retention basins, if needed, will be designed so that retained water does not encroach within 10 feet of the centerline of any track.

Subgrade under tracks, to the toe of the ballast shoulder, will be sloped to drain water away from the tracks and into the trackway drainage system. The standard subgrade transverse slope shall be 1:40 (see Section 3.2.1 – “Subgrade”).

For trackway drainage, surface drainage is preferred using earth swales where practical. Lined swales shall be specified where water velocity would cause erosion or where the slope is less than 0.5 percent and lining is required to ensure positive drainage. An underground drainage system of inlets and underground pipe (underdrains) may be used for trackway drainage where surface drains are not feasible. Except for underdrains, pipes conveying trackway drainage under the tracks shall be reinforced concrete, minimum of 18 inches in diameter. These pipes shall have concrete headwalls and aprons or inlet/outlet structures on both ends of the pipe to prevent erosion. Inlets shall be precast or cast-in-place concrete and have grate covers that prevent ballast and debris from entering the drain.

Underdrains and perforated underground drains are discouraged as a system to collect trackway drainage. Underdrains may be used, if required, with the approval of the project manager. Underdrains shall conform to the requirements of Volume 1, – Civil Work, “Project

Hydraulics” Section. If underdrains are used, the design shall include invert information for all pipes and cleanouts/manholes for each system segment.

The designer shall, by overlaying project plans, ensure that the trackway drainage system facilities are not in conflict with, or obstructed by other project elements including, but not limited to, catenary poles, switches, signal cases, and traction power-vaults.

1.1.2.2 Grade Crossings

At grade crossings, street drainage shall be intercepted immediately up gradient of the grade crossing and conveyed into the natural or urban drainage system. The street drainage may be intercepted and conveyed into the trackway drainage system, with the approval of the SANDAG Project Manager if this is the only feasible alternative for addressing street drainage. The designer shall calculate the size of the inlets and pipe in accordance with the requirements of the local agency. The designer shall use the local agency standards and plans to design and specify drainage facilities. The designer of the drainage system shall work with the design team, including the signal engineers, to ensure that drainage structures are not located in the way of crossing warning and traffic signal system equipment.

1.2 Utilities for LRT

1.2.1 Traction Power Requirements

Each traction power substation shall be fed from separate distribution circuits. Adjacent traction power substations shall not be fed from the same grid unless otherwise approved by the SANDAG Director of Rail. For additional requirements regarding traction power design, refer to Chapter 5 –Traction Power.

1.2.2 Design Requirements for Underground Utilities

All wet utilities 30 inches or less in diameter, other than drainage crossing, shall be in steel casings as mentioned in Volume 1 – Civil Work, “Design Requirements for Underground Utilities Section”. Casing under LRT tracks and across LRT right-of-way shall not be less than 35.5 feet from the base of the LRT rail to the top of the casing at its closest point.

1.2.3 Risk Assessment

The designer shall prepare a risk assessment on all utilities within or proposed to be located within the railroad Right-of-Way, within the project limits. The risk assessment will evaluate potential impact of utility failure on SANDAG/MTS operations and identify alternatives to mitigate risk including relocation, removal or reinforcement. The risk assessment shall identify the utility owner and property rights associated with the utility.

1.3 Right-of-Way Requirements for LRT

1.3.1 At-Grade Construction

1.3.1.1 General

The designer shall recommend right of way requirements for LRT guideway based on track centers, grade, cross slope, catenary configuration, signal and grade crossing protection equipment, drainage facilities, construction and maintenance access. Development of right-of-way recommendation would require coordination between various design disciplines as

well as MTS maintenance personnel. The designer shall in general attempt to minimize right of way cost and area required for a project. The designer shall consider maintenance, clearance, working room and inspection requirements when establishing right of way limits. The designer shall consider realignment, retaining walls, structures and other design alternatives to avoid expensive right of way impacts for approval by SANDAG. Right-of-way for joint use of track where heavy rail is involved shall incorporate criteria set forth in Section 3.1.9 – “Joint LRT/Freight Rail Corridor”.

Catenary poles including assemblies, substations, signal cabinets, grade crossing protection devices and other rail infrastructure facilities shall be placed inside the existing or proposed guideway right of way limits wherever possible. Where these facilities cannot be designed within the guideway limits, additional right of way shall be identified. To the extent possible the additional right of way shall be contiguous with the guideway right of way limits. Where the additional right of way cannot be contiguous, legal access to a public right of way shall be provided.

1.3.1.2 Height Limits

California Public Utilities Commission General Order No. 95 and 26 D must be used to determine the minimum aerial right of way easements or use restrictions for encroachments over the railroad right of way for any proposed encroachments as part of a SANDAG project or project proposed by an outside entity.

1.3.1.3 Lateral Limits

The minimum width of right-of-way for a level track cross-section, including the trackbed and the catenary system support poles, is 35 feet for open track areas.

Tracks placed in streets shall have a minimum right-of-way width of 27 feet.

1.3.2 Aerial Construction

Right-of-way for LRT bridges and viaducts shall not be less than the width of the structure plus two feet on either side of the drip line of the bridge, but shall be greater as needed for maintenance and inspection. Right of way for aerial structures shall include legal access from public right of way to all columns and abutments. California Public Utilities Commission General Order No. 95 must be used to determine vertical right of way required between the overhead catenary system and any height limiting structure.

1.3.3 Drainage and Utility Easements

LRT facilities shall avoid existing drainage or utility easements where possible.

1.3.4 Traction Power Substations

Right-of-way required for traction power substations shall include legal access from a public street or the railroad right of way to a substation site with sufficient area to provide a level pad in a size to accommodate substation configuration including ground mats and perimeter fencing. Typical sizes for substation sites are given in Section 4.9 – “Traction Power Substations”. Substations may also be placed in secured locations at LRT station sites.

1.3.5 Right-of-Way Safety

1.3.5.1 Access

The general public shall be prohibited from entering restricted or non-public ROW areas through the use of barriers and signs. Access to restricted ROW areas shall be limited to authorized personnel and vehicles only, including operations and maintenance personnel, other agencies with specific access requirements such as utility companies, and emergency response teams.

1.3.5.2 Means of Egress

By no means shall any barrier inhibit egress of the general public, within a publicly accessible area, to an area of safety. Egress from a publicly accessible area into any designated area of safety shall be clearly identified per Title 24, Part 2, Volume 1, Section 1114B.2.

2.0 LRT STATIONS

LRT stations shall be designed to fit the operational and community environment. Station design shall consider patron load, access and exiting requirements, accessibility, fare collection, safety and security, sight line visibility, cover, amenities and where applicable intermodal connections, parking and joint development. Station concepts shall be prepared as part of the project development phase of a project.

Stations shall be on constant grade tangent track. Track grade through a station shall be 0.5 percent preferred and maximum 2 percent. All tracks shall have the same elevation and profile. Any variance from these requirements shall require approval as a separate design deviation or deviation included in a basis of design report.

Typical station layout consists of two outside platforms, one for each direction of train travel. At high volume stations, a center platform in conjunction with side platforms (see Section 2.3 –“Platform Geometry”) shall be provided as approved in project development by the SANDAG Project Manager.

General design criteria for LRT stations shall comply with Volume 1 – Transit Centers. Additional criteria specific to LRT stations are as follows:

2.1 Site Layout

2.1.1 Platform General Circulation and Access

LRT station platforms shall be designed to facilitate good pedestrian and wheelchair movement and access. Platforms shall have a minimum of an 8 foot setback to any obstructions from the loading edge of platform. Platform design shall minimize obstructions and channelize access to encourage safe, convenient and direct patron access to loading areas. Platform design shall place fare vending and validation equipment at station access points in a manner that provides visibility to the equipment without creating obstructions.

At-grade stations shall be open ballast track for the full length of the platform with precast or placed concrete pedestrian crossings at the ends of the platform and two mid-platform crossings 180 feet apart symmetrical to the center of the platform. ADA compliant curb ramps and crossings shall be provided at each end crossing of the platforms. The two mid-platform crossings shall not have curb ramps (See Figure 2-1).

At-grade stations at locations expected to have high volumes of pedestrian crossings between platforms such as: urban center environments, stations with large special event crowds, or in areas where the trackway outside the station limits is paved, shall have fully paved trackway for the full length of the platform.

Aerial stations shall have removable pre-cast concrete panels in the trackway, for the full length of the platform.

2.1.2 Bus and Parking Circulation Access

LRT stations with bus routes onto the station and parking lots shall be designed to encourage safe, convenient, and direct patron access between the bus and parking areas to the platform

loading areas. Access from bus bays, bus islands, on-street bus stops and parking areas shall be designed to maximize accessibility; buses shall have at least one ADA compliant path of travel to the platform loading areas. Stations with parking shall include ADA compliant parking spaces, and as directed kiss-and-ride parking that has full ADA accessibility between the parking area and the platform loading areas.

2.2 Service Access

Station platforms shall be designed to maximize access for revenue collection, maintenance, security and emergency response vehicles, while at the same time discouraging access by private vehicles. The design shall consider the following:

- Access points shall be clearly marked with signage indicating authorized personnel only;
- Lockable and movable barriers such as swing gates, chains, or bollards shall only be installed as directed by the SANDAG Project Manager and with the concurrence of MTS;
- Lockable, movable barriers shall not be used in areas of access for emergency response vehicles;
- Service access for fare collection vehicles shall be as close to the platform at-grade or station access locations for aerial stations as feasible and provide a clear line of sight to the fare vending equipment.

2.3 Platform Geometry

Stations shall be located on tangent track. If horizontal curves are approved by design exception, tracks shall not be superelevated. Side platforms shall be used in LRT stations unless site-specific factors, such as clearances or right-of-way limits, prevent their use (See Figures 2-1 and 2-2 for typical station layout). Center platforms will require the approval of the SANDAG MMPI Director of Rail. Stations at junctions or with high passenger or special event loads shall be considered for center loading platforms in conjunction with side loading platforms.

2.3.1 Platform Length

Platforms shall be 360 feet in length to accommodate a four-car train.

2.3.2 Platform Height

Top of platform at boarding edge (or curb height) from top of rail profile shall be a uniform 8-inch along entire length of platform. Top of platform means the finished top of curb elevation.

2.3.3 Platform Width

The minimum standard platform width shall be 15 feet. The platforms, mezzanines, and passenger assembly areas shall be sized based on the reasonably expected maximum demand, using 6sqared feet of space per person. If a platform's only exit is across the tracks, the platform should be wide enough to accommodate a full-train load of people (see Section 7.6 – “LRV Loading” for car loading capacities). The absolute minimum width for a

platform is 10.5 feet. Any width other than 15 feet will require the approval of the SANDAG Director of Rail.

The front edge of the platform curb line shall be 4 feet-10 inches from the centerline of the adjacent track.

2.3.4 Grade

Track and platforms shall have a uniform straight grade through the full length of the platform and end of station crossings. The preferred longitudinal grade is 0.5 percent for ballast track. The maximum longitudinal grade through a platform shall not exceed 2 percent, except where a station is at a location with existing track or street grades in excess of 2 percent; in these locations station grade shall match the existing. Stations shall not be placed on grades in excess of 4 percent. The maximum cross slope on the platform shall not exceed 2 percent. Platform shall slope away from the boarding edge unless a drainage system is provided in the trackway, and aerial stations slope towards the trackway. Grades for curb ramps and any other ramps included on the platform shall comply with current ADA requirements (see Volume 1 – Transit Centers, “General Circulation and Access – Pedestrian Circulation” Section).

Figure 2-1. – Typical Station Dimensioning (Plan View)

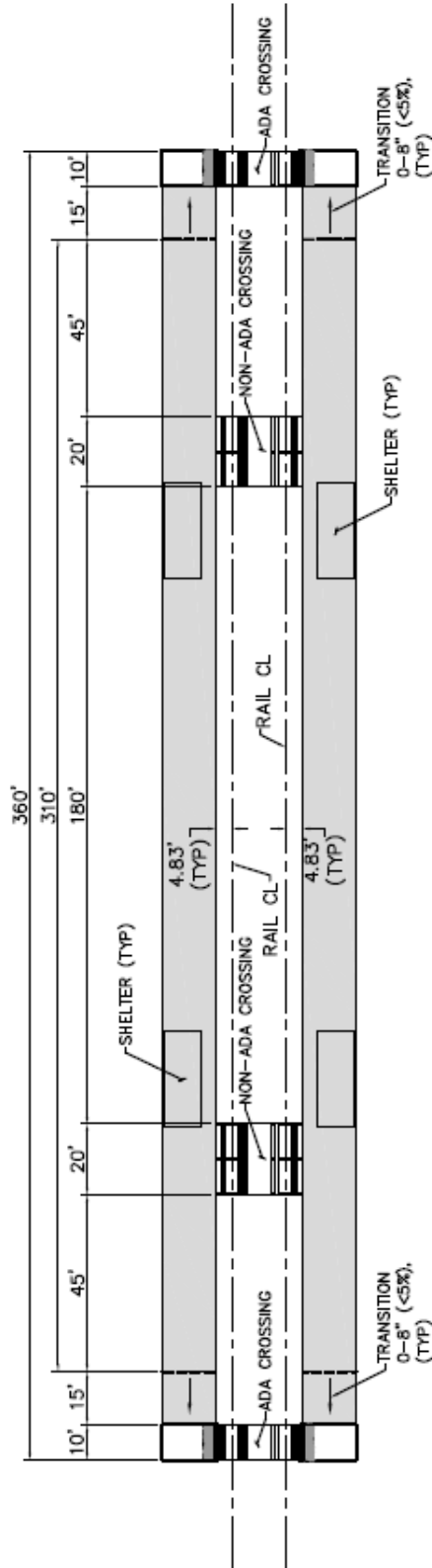
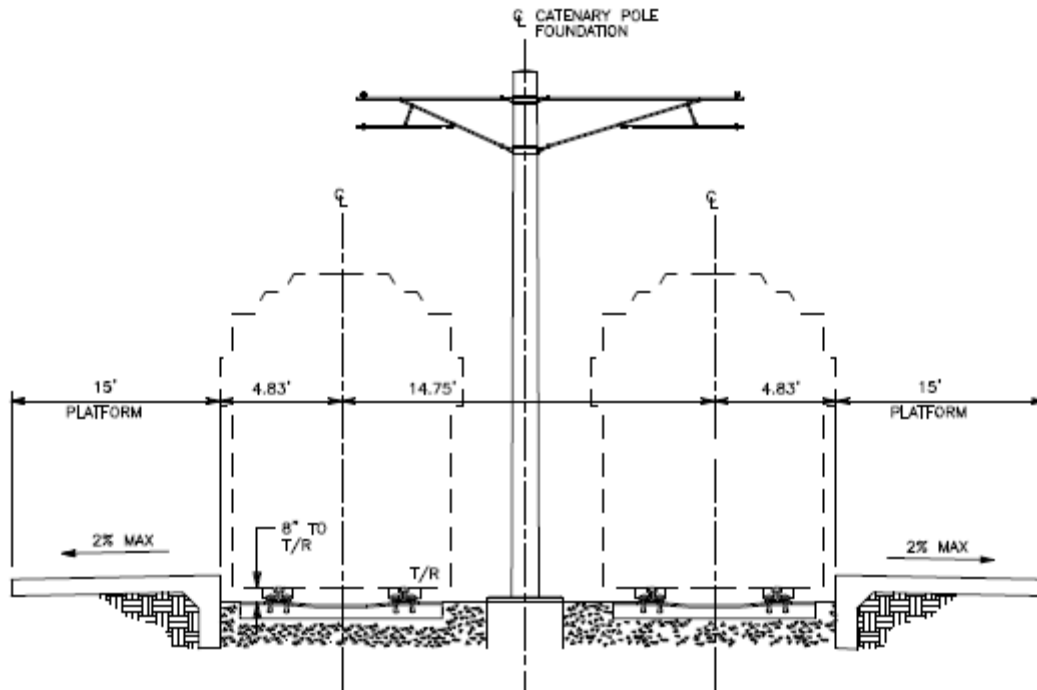

Figure 2-2. – Typical Station Dimensioning (Section View)



2.4 Station Amenities

2.4.1 Shelters

In general, shelter design shall comply with Volume 1 – Transit Centers, “Shelters” Section.

Where stations are limited in space or service a low volume of patrons, one shelter may be used on each platform.

2.4.2 Public Information Communications

(Note: Public Information Communications criteria shall also apply to transit centers)

2.4.2.1 Signs - General

Station signs shall be designed in coordination with MTS. The location and mounting details for all signs shall be called out in the plans and comply with the general layout as shown on Figure 2-3 and the MTS Sign Design Guidelines Manual. If possible, station signs will be mounted to light poles at a height of 8-11 ft. Other station appurtenances such as public address speakers shall be placed so as not to conflict with sign locations.

Station signage shall have a minimum clear head room of 7 feet and vehicle clearance requirements. Station signage shall comply with ADAAG Sections 4.4.2, and 4.30.1 through 7, and 10.3.1 (4), (5), (6), California Accessibility Reference Manual (CARM) Section 61, California Title 24, Part 2, Volume 1, Sections 1103.1.4, 1117B.5, and 1127B.3, and California Public Utilities Commission General Orders 26-D and 143-B as applicable.

Figure 2-3. – Typical Station Signage Configuration

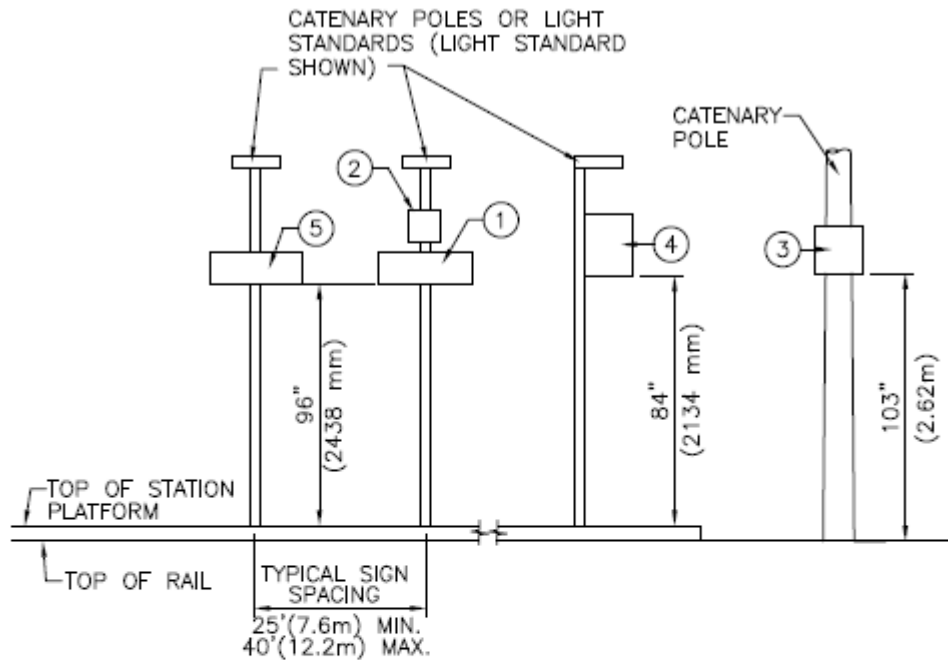

SCHEDULE OF STATION SIGNS				
TYPE	DESCRIPTION	SIZE (WIDTH X HEIGHT)		EXAMPLE TEXT
1	STATION NAME SIGN	W*x12	W* x 305mm	GROSSMONT CENTER
2	STATION NUMBER SIGN	12x12	305mm x 305mm	15
3	ADVANCE SIGN	18x18	457mm x 457mm	GROSSMONT CENTER STATION
4	STATION DESTINATION SIGN	24x30	610mm x 762mm	TO EL CAJON
5	FARE PAID ZONE SIGN	24x20	610mm x 508mm	FARE PAID ZONE-TICKET REQUIRED
* WIDTH VARIES				

NOTES:

1. SIGN TYPES ① ② ⑤ SHALL BE PLACED PARALLEL TO TRACKS.
2. SIGN TYPES ③ ④ SHALL BE PLACED PERPENDICULAR TO TRACKS.
3. SIGN TYPE ③ SHALL BE IN CLEAR VIEW OF APPROACHING TRAINS.
4. DETAILS SHALL BE IN ACCORDANCE WITH MTS DESIGN GUIDELINE MANUAL.
5. SIGNS SHALL BE PLACED ON LIGHT STANDARDS WHEREVER POSSIBLE.
6. PROVIDE MINIMUM CLEARANCE FROM ϕ OF TRACK PER SECTION 3.1

2.4.2.2 Signs - Track ID

At stations with more than two platforms, signs designating track numbers may be required.

2.4.2.3 Station Identification Signs

Station identification signs shall be placed on each station platform to inform persons on the train what station they are arriving in. Identification signs shall be parallel to the LRT tracks, facing station platforms, and shall be located roughly every 60 feet. Each station identification sign shall be accompanied by a station number sign.

2.4.2.4 Tactile Signs

One tactile sign shall be located on each platform, at the back of platform directly behind the directional bar mat (Volume 1 – Architectural Treatments, “Directional Bar Mat” Section). The tactile signs will repeat information given on the station destination and station identification signs. The tactile signs shall have raised letters or numerals accompanied with Grade 2 Braille, in accordance with ADAAG, Sections 10.3.1 (4), 10.3.1 (6), 4.30.4, and 4.30.6. Because they are within reach of the public, and therefore subject to above average levels of theft, the tactile signs shall be welded or otherwise securely fastened to their supports with tamperproof hardware.

2.4.2.5 Fare Paid Zone Signs

Fare paid zone signs shall be located at all access points to the platform, and along the platform to ensure that individuals are aware of the requirement to possess a ticket. The signs shall be consistent with sign procurement specifications from previous SANDAG LRT projects. As directed by the SANDAG Project Manager, fare paid zones may also be indicated with a distinctive change in pavement color or texture.

2.4.2.6 Advance Station Signs

Advance station signs shall be placed along the right-of-way, on catenary poles, approximately 400 feet to 500 feet from each station and facing the travel direction of the approaching train. These signs shall notify the LRT operator of the upcoming station so an announcement can be made to passengers in advance of the station stop. Advance signs shall be placed to face oncoming LRVs as shown in Figure 2-3. For sign lettering specifications, mounting requirements, and height, refer to operator requirements.

2.4.2.7 Miscellaneous Directional Signs

Other signs shall be included to direct patrons to accessible routes, major nearby attractions, and various station facilities. Station signs shall be located with consideration for other station amenities and landscaping to assure that a clear line-of-sight is provided.

2.4.2.8 Variable Messaging System (See Section 6.9) and Public Address (See Section 6.8)

2.4.2.9 Transit Next Bus Messaging System (TNBMS)

MTS has certain routes equipped with a Next Bus Messaging System. Trolley stations designated transfer or transit centers or stations with dedicated bus bays within the station limits shall be designed with power and communications conduit from the Next Bus sign locations to a cabinet or connection point for this system.

2.4.2.10 Information Sign Frames

Each station shall have at least one double sided information sign frame per platform, typically located near the fare vending machines. Design plans shall show the location of the

sign frames and reference the SANDAG standard sign frame drawing. Where non-standard sign frames need to be designed to accommodate specific station conditions, the designer shall provide a detailed design. To the extent feasible, non-standard frames shall be similar in design to standard sign frames in size and construction.

2.5 Fare Collection (See Fare Collection Technology, Section 6.10)

2.6 Station System (See Communications, Chapter 6.0)

2.7 Electrical

2.7.1 General

Stations shall be provided with an electrical service, service equipment, and distribution systems designed to supply power to electrical loads associated with the station. The station's loads will typically consist of lighting systems, revenue equipment, communications systems, convenience receptacles, and irrigation systems. Additionally loads that may require an electrical service, as part of the Station's electrical design, include Railway Signaling and Indicating Systems equipment, and vendor provided equipment.

The Station's electrical design shall be in accordance with the latest effective version of the California Electrical Code (CEC), California Code of Regulations, Title 24, Part 3; SDG&E's Service Standards & Guide; the "Environmental Operating Range", Table 6.1; and with the requirements identified within these design criterions.

Electrical equipment shall be in accordance with Section 6.1.4 - "Regulations, Codes, and Standards".

2.7.2 Electrical Service

An electrical service shall be designed to provide power for the present and anticipated future loads. The electrical service equipment shall house the utility revenue meter and be provided with a main circuit breaker type disconnect switch, a bolt-on type circuit breaker panelboard, and lighting contactor and controls. When present, Railway Signaling and Indicating Systems equipment and vendor provided equipment shall be powered from individual utility revenue meters and main circuit breaker type disconnect switches. An exception to this requirement is for vending machines located on or adjacent to the Station's platforms which are permitted to be powered by dedicated branch circuits from the Station's panelboard. The designer shall verify the presence of all electrical loads associated with the station and provide a design for the electrical service and equipment. The design shall include the following, as a minimum:

- **Service Equipment and Wiring Diagram:** This shall be based on Caltrans' Standard Plans and Standard Specifications, except as modified below, for services with up to two 200 amp utility revenue meters. For services with more than two 200 amp utility revenue meters or of larger ampacity, the design shall be for custom engineered service equipment with the appropriate number of utility revenue meters, main circuit breaker type disconnect switches, panelboard(s), and other required equipment. The minimum service equipment ampacity for a Station is 200 amps. Modifications to the Caltrans Standard Specifications for service equipment include the following:
 - Service equipment, including panelboard and ancillary equipment contained therein, shall be rated for a minimum fault current or 42,000 amps.

- Service equipment enclosures shall be shall be manufactured from Type 304 stainless steel, 14-gauge minimum.
- Load Calculations and Panelboard Schedule(s): The load calculations shall show the total service ampacity at the rated voltage and number of phases, the load(s) to be served by each utility revenue meter/ main circuit breaker type disconnect switch pair, and for any new station’s electrical service, it shall include the calculated loads plus 20 percent spare usable ampacity, but shall not be less than 200 amps. Panelboard schedules shall explicitly identify the loads served, as required by the CEC Article 408, and show assumptions used to determine loads on each circuit.
- Electrical Plan: A design drawing shall be provided which shows the location of the service equipment, identifies associated conduits, pull boxes and conductors, and in general, complies with the requirements for Section 6.3.1.3 - “Locating Communications Enclosures”. In addition, the drawing shall identify work required for the electrical service based on SDG&E’s requirements.

Additions or modifications to existing electrical systems, and designs requiring a new electrical service shall be coordinated with the SANDAG Utility Coordinator in accordance with Volume 1 – Civil Work, “Utilities” Section. As a minimum, the design information identified above shall be provided to the SANDAG Utility Coordinator. The Plans shall identify the required AIC rating for circuit breakers. Typically, a 42 kAIC is available at the service from SDG&E and shall be verified by the designer. A short circuit current analysis shall be done to determine the appropriate rating.

2.7.3 Electrical Distribution System

The electrical design shall include an electrical distribution system to provide power to the Station’s various pieces of electrical and communications equipment requiring power. As a minimum, the distribution system shall consist of a circuit breaker panelboard, fed from the electrical service, conduits, conductors, and pull boxes. The Station’s conduits will typically consist of a main ductbank of direct buried or concrete encased 3-inch conduits routed from end-to-end of each of the Station’s platforms with an interconnection between platforms to allow conductors to be routed from their point of origin to the electrical and communications utilization equipment.

The ductbanks will contain conductors and cables from electrical and communications systems installed in conduits and associated pull boxes for each of the two systems. The separation into systems will be determined by operating voltages and as required by the CEC Articles 725, 770, 800, and 830. Typically separation is 50 volts and greater-electrical, less than 50 volts-communications.

The ductbank design shall allow for the future addition of conductors and cables by supplying empty conduits, a minimum of one 3 inch conduit in each main ductbank run or segment.

The ductbanks installed along the length of the platform with have pull boxes installed at the platforms’ ends, off of the platforms for future access, and at midpoint of the platforms, as a minimum.

The ductbanks are to be installed in or under the Station’s platforms.

The ductbank will also contain conduits from the main ductbank's pull boxes to the various pieces of electrical and communications utilization equipment for the routing of conductors.

Refer to Chapter 6 – Communications for additional distribution system requirements for communications equipment.

2.7.3.1 Panelboards

Panelboards shall be sized for the connected loads, including anticipated future loads, and shall have usable spare spaces or installed spare circuit breakers, shall have 20 percent minimum spare usable capacity, shall not be less than 200 amps, and contain a minimum of 24 branch circuit spaces for the Station's main panelboard. Bus bars shall be 98 percent conductive copper conforming to ASTM B187, and contact surfaces shall be silver plated.

2.7.3.2 Circuit Breakers

Circuit breakers shall be of suitable ratings and type to protect conductors and electrical and communications utilization equipment from the effects of short circuits, or overloads. Circuit breakers shall be 80 percent rated, molded case, quick-make/quick-break bolt-on type, thermal magnetic type trip with interchangeable trip units for circuit breakers rate 125 amperes and above, and comply with the requirements of UL 489. The design shall indicate the ampere-rating, number of poles, and interrupting capacity on the plans.

GFCI circuit breakers shall be used for the Stations' platforms duplex receptacle circuits in conformance with the CEC Article 210.

2.7.3.3 Conduits

Conduit and fittings shall comply with and be of the types identified in the Caltrans Standard Specifications, Section 86, "Conduit". Direct buried or concrete encased conduits shall be Caltrans Type 3. Exposed conduits shall be Caltrans Type 1. Caltrans Type 4 conduit shall be used in exposed locations where the conditions require flexibility, not as a substitute for conduit bends or fittings.

The design shall show and identify existing conduits sizes, if applicable, and new conduit sizes and types with proposed routings. The use of "homeruns" does not satisfy this requirement. Conduit sizes shall be based on the fill requirements of the CEC Chapter 9, Table 1. The minimum size for direct buried or concrete encased conduits is 1 inch, and typical main ductbank conduits shall be a 3-inch.

Bell end shall be provided on Caltrans Type 3 conduits not terminated to an enclosure, and grounding type bushings or hubs shall be provided on Caltrans Type 1 conduits

A pull tape shall be provided in each spare or unused conduit.

Refer to Chapter 6 – Communications for additional conduit requirements.

2.7.3.4 Pull Boxes

Pull boxes shall be traffic rated and comply with the Caltrans Standard Plans and Standard Specifications, Section 86, "Pull Boxes", or comply with the SDG&E Standard 3313 detail, and as identified herein. Pull boxes shall be installed flush with platforms or other pedestrian walkways.

Plastic or non-concrete pull boxes are not acceptable.

Pull box cover markings shall include the text “MTS” and text identifying the type of system conductors or cables contained therein. Typical system types are:

- Electrical
- Communications
- Lighting
- Signal
- Fiber Optic

Pull boxes installed for the installation of utility conductors or cables shall be in accordance with the utility companies’ requirements.

The design shall identify the pull box types, sizes, and systems. Pull box sizing shall comply with the CEC Article 314.

2.7.3.5 Conductors and Cables

Electrical power circuit conductors shall comply with the Caltrans Standard Specifications, Section 86, “Circuit Conductors” and CEC Articles 200, 210, 215, and 310.

The design shall identify conductor sizes and quantities. Conductor sizing shall account for temperature, conduit fill, and voltage drop adjustment factors. Voltage drops shall be limited to 3 percent for feeders and branch circuits with as a maximum total voltage drop for feeders and branch circuits of 5 percent.

Conductors and cables shall be continuous between terminations, without splices, except as permitted. Permitted splices shall be with junction boxes, pull boxes, hand holes or other accessible locations. Permitted splices include taps for lighting circuits, and receptacle branch circuits. The request for splicing for other wiring will require SANDAG approval.

Refer to Chapter 6 - Communications for additional conductor and cable requirements for communications equipment.

2.7.3.6 Miscellaneous Electrical Equipment

Each of the station’s platforms will be provided with three receptacles, in lockable, weatherproof enclosures, distributed along the length of the platforms. The receptacles will be connected to GFCI type circuit breakers. The receptacles shall be Commercial Specification Grade, weather resistant, NEMA Type 2-20R.

2.7.4 Grounding

The design shall provide a Grounding Plan that identifies the requirements for a Grounding Electrode System (GES) as defined in the CEC, Article 250 and complies with the Caltrans Standard Plans and Standard Specifications, Section 86, “Bonding and Grounding”. The GES shall provide a continuous low impedance connection to the grounding electrodes and exposed structural steel elements of the station, such as passenger shelters, that may become energized. Metal benches under or within six feet of passenger shelters shall be

bonded to the GES. In addition, the GES shall be connected to the Communications system's ground grid. Refer to Chapter 6 – Communications for additional grounding requirements.

The GES shall consist of at least one ground rod housed within an accessible ground well at or near the electrical service equipment, the grounding electrode conductor, and other available grounding electrodes and bonding connections. The GES shall include bonding connections to the electrical service equipment, Communication Enclosure or Building ground grid, and electrical pull boxes and enclosures. The GES shall be tested by the Contractor in conformance with the "fall of potential" method described in IEEE Bulletin No. 82, using a Biddle "Earth Megger" or a SANDAG approved equivalent method and test procedure. Should the test results show that the ground resistance is not less than 5 ohms, then additional grounding material (e.g. ground rods, cables, exothermic connections) shall be added to reduce the ground resistance to less than 5 ohms.

Electrical conduits shall contain an Equipment Grounding Conductor (EGC) sized and installed as required by CEC Article 250. The EGC conductor shall be insulated.

2.7.5 Lighting

2.7.5.1 General

Stations shall be provided with adequate lighting systems powered by the electrical distribution system. The lighting systems shall be in accordance with Volume 1 – Architectural Treatments, "Lighting" Section.

2.7.5.2 Contactors and Controls

Lighting contactors and photoelectric controls shall be the Caltrans Type V and equipment shall be in accordance with the Caltrans Standard Specifications, Section 86, "Photoelectric Controls".

Time clocks shall be of the astronomical type.

2.7.6 Utilization Voltages

The preferred utilization voltages for electrical equipment and lighting are identified in the following:

Platform Lighting	240 volts (or 208 volts), single phase
Shelter Lighting	120 volts, single phase
Parking Lot Lighting	240 volts (or 208, 277, or 480 volts), single phase
Receptacle Outlets	120 volts, single phase
Communications Cabinet	120/240 volts, single phase

The designer shall determine the utilization voltages present at existing stations and confirm the available utilization voltages with the SANDAG's Utility Coordinator within the vicinity for new stations and provide a design based on these voltages.

2.8 Ventilation for Subterranean Station

Refer to Volume 1 – Safety and Security, “Tunnels – Emergency Ventilation” Section, for ventilation requirements.

2.9 Fire Protection, Alarm, and Emergency Management Systems

The designer shall prepare complete Plans, Special Provisions, and Engineer's Estimate for a fire protection, alarm, and emergency management systems where specified or required that shall conform to all applicable federal, state, and local requirements for fire protection systems and fire-resistant materials and construction including, but not limited to, the requirements of the NFPA 72, 13 and NFPA 130 most important and other associated NFPA Codes, Uniform Building Code (UBC) and California Building Code (CBC). Provide a dry standpipe at elevated stations and any other station location that is not easily accessible for firefighting activities.

Elevated stations with elevators shall have an Intelligent Fire Alarm Control Panel (FACP) that: a) receives information from environment sensors (e.g. fire), b) monitors sensor integrity, c) automatically controls response equipment, and d) transmission of information that is used to respond to fire based on a predetermined sequence. The FACP shall not only prepare the station facility for fire based on predetermined sequence, but it shall also provide active status information, alarms, and other alerts to the incident commander, the AIMS, system and other predetermined facilities. The FACP shall interface with the existing Simplex Grinnell Incident Commander (IC) located in the San Diego Trolley Inc. (SDTI) Operations Control Center (OCC) via existing and new dedicated fiber optic strands in the non-vital WAN cables that form a redundant ring solely for the use of the Fire Life Safety System in conformance with all NFPA, MTS, and state or local jurisdiction requirements.

Enclosed stations, typically in tunnels, shall have an Emergency Management Panel that: a) receives information from environment sensors (e.g. fire), b) monitors sensor integrity, c) automatically controls response equipment, d) transmission of information that is used to respond to fire based on a predetermined sequence, and e) provide first responders with a location to manage the response to the fire including, but not limited to, control of ventilation fans, public address, and electronic messaging systems within the tunnel and station facilities and/or station platforms. The EMP shall communicate with the existing Simplex Grinnell Incident Commander (IC) located in the San Diego Trolley Inc. (SDTI) Operations Control Center (OCC) via existing and new dedicated fiber optic strands in the non-vital WAN cables that form a redundant ring solely for the use of the Fire Life Safety System.

Dedicated fiber optic strands within the 144 strand SMF cable shall be allocated to form a Fire Alarm Management System solely dedicated to link Intelligent Fire Alarm Control Panels (FACP) at elevated stations and Emergency Management Panels (EMP) at underground stations to the existing Simplex Grinnell Incident Commander (IC) located in the Operation Control Center. In order simplify system integration with the Incident Commander at the OCC the FACP shall be a Simplex 4100 series panel or accepted equivalent. The dedicated Fire Alarm Management System fiber optic strands shall form a redundant ring connecting all of the panels to each other and linking them with the OCC. The designer shall meet with SANDAG and MTS to obtain information about the existing dedicated fiber connections and determine how to connect in the additional FACP located along a new line segment or to link up an existing station that is being upgraded with new Simplex Grinnell compatible Intelligent Fire Alarm Control Panels.

Early in the design phase the designer shall meet with MTS, SANDAG, and the CalFire deputy Fire Marshal and/or local jurisdiction if available to present preliminary design concepts for the station Fire Alarm and Control System at elevated and enclosed underground stations and obtain input on desired system functionality and configuration. At the meeting the designer shall present: a) preliminary site layout identify locations of egress and present preliminary concepts of environmental detection sensors (fire), FACP or EMP location, fire response system features, etc., b) functional description of environmental sensing system, alarm and response system required to conform the minimum NFPA requirements, c) a functional description of additional features not required by NFPA, but suggested by the designer, d) a preliminary list of sensor, alarm and control features that will interface with the incident commander at central control. Following the preliminary meeting the designer shall finalize the design concepts based on the input received at the meeting and then distribute the draft concept document. Once accepted by MTS and SANDAG meetings shall be arranged the State of California Deputy Fire Marshal, "State Fire Marshall" (SFM) or city having jurisdiction (CITY) to review the design concept and confirm system conforms to minimum requirements. Design concept shall be modified as needed to adequately address the SFM/CITY requirements.

The SANDAG LRT Design Criteria, conceptual report, NFPA 72 current 2013, ADA, federal, state, and local jurisdiction codes and requirements and requirements shall collectively form the basis of design of the system.

The final design documents shall include plans, special provisions and estimate for the system and include, at a minimum: a) regulatory requirements, b) standard references (e.g. UL and Factory Mutually Approved) c) product specifications, d) Training, Certification, and Licensing Requirements of Technicians by the State of California for Fire Alarm Installation work, e) OCC Incident Commander interface requirements including, but not limited to, interface schematics, IP and Bit Addressing tables, e.g., f) Contractor Qualification Requirements, g) Submittal Requirements, h) site plans showing equipment, devices, sensors, control or management panels, and all other pertinent information, i) system description and functional requirements, j) Single Line Diagrams showing system configuration and wiring diagrams, k) FACP/ EMP power supply panel schedules and circuit configurations including primary and secondary power supplies and circuit disconnects, l) remote power supply requirements for audio and visual notification systems and auxiliary features (when desired or required), m) FACP and EMP annunciator display requirements, n) product specifications, o) installation specifications, p) automated system notifications, q) circuit break down testing, functional and operational acceptance testing requirements, r) SFM/City acceptance and certification requirements, s) test records, t) as-built record requirements, u) warranty requirements, and v) various other requirements.

During the design development phase the designer shall provide / obtain and review sample specifications and arrange a meeting with SANDAG and MTS to identify specific product requirements inclusion in the Specifications to ensure the products will conform to the desired operation with existing equipment, performance and functional needs of MTS.

All fire life safety computer aided drawing files shall be provided by the designer to SANDAG Systems Configuration Manager. The contractor shall update design drawings with as-built information and submit final drawings for the installed system.

2.10 Fire/Life Safety (Elevated or Underground Station)

Stations shall be provided with a minimum of two means of egress; one at each end of the platform, on both sides of track, such that “dead ends” will not exceed 20 feet (Figure 2-4). Passenger holding areas at the end of station platform shall be considered for mobility impaired patrons, or where emergency exit is limited. This requirement shall be coordinated with the Fire Marshal of the appropriate jurisdiction.

All underground stations shall be designed with a deluge and fire auto-detect system and traction power isolation and disconnects integrated with the fire control system in accordance with the requirements of the CPUC, CBC and State Fire Marshal. For additional safety requirements see Volume 1, – Safety and Security.

Figure 2-4. – Typical Layout for Means of Egress (Elevated Structure Shown)

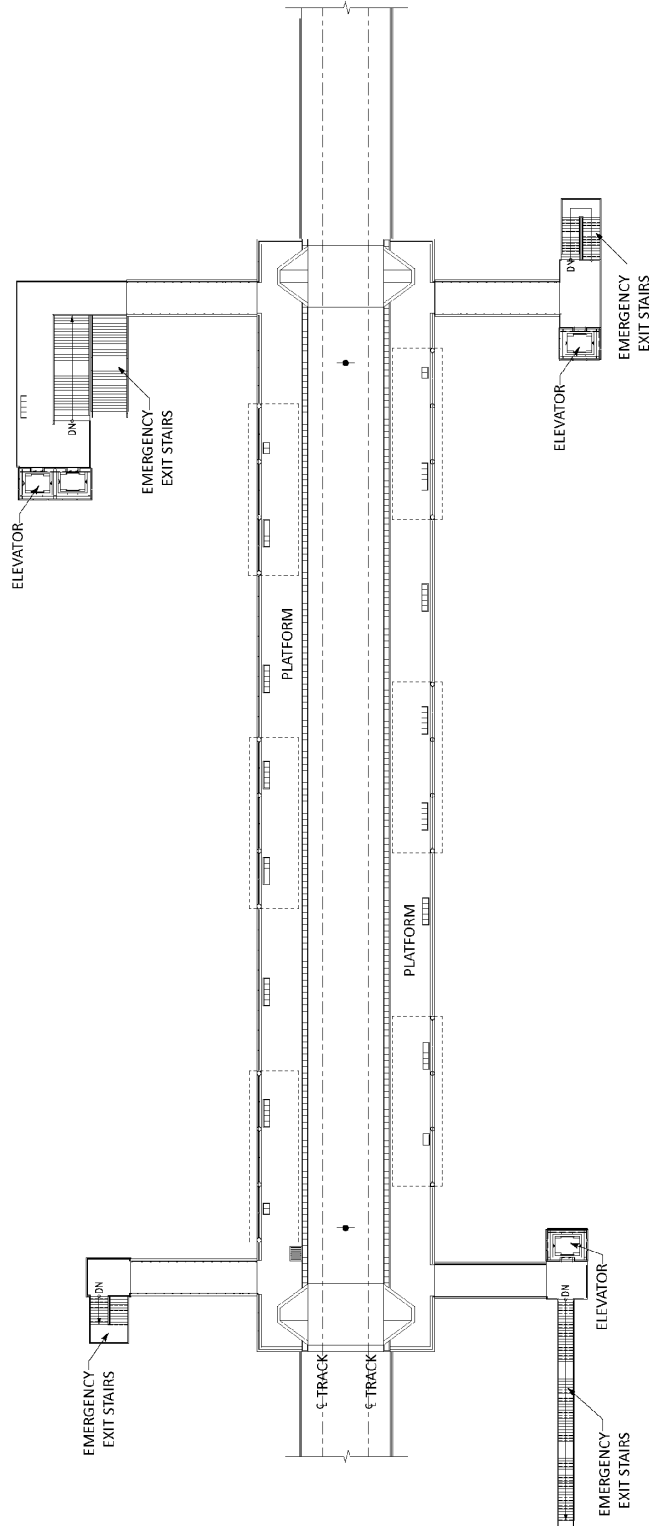

3.0 TRACKWORK

This section addresses minimum standards for and design of LRT only and joint LRT and freight/passenger train trackage, and trackwork requirements. Track design shall be in accordance with the American Railway Engineering and Maintenance-of-Way Association (AREMA) Manual unless otherwise modified herein. The basis for all track design work shall meet the current track safety standards of the California Public Utilities Commission (CPUC) General Order (GO) Nos. as follows:

- G.O. No. 26 (Effective Version G.O. No. 26-D: Clearances on railroads and street railroads as to side and overhead structures, parallel tracks and crossings);
- G.O. No. 33 (Effective Version G.O. No. 33-B: Construction, reconstruction, maintenance and operation of interlocking plants of railroads);
- G.O. No. 95 (Overhead electric line construction);
- G.O. No. 143 (Effective Version G.O. No. 143-B: Design, construction and operation of light rail transit systems);
- G.O. No. 164 (Effective Version G.O. No. 164-D: Hazard Analysis sections only).

In addition, where the LRT System operates in a public street, applicable design requirements of the American Association of State Highway and Transportation Officials (AASHTO), the California Department of Transportation (Caltrans), the CPUC, or the local municipality shall also be applied as required or determined to be appropriate by the designer and SANDAG.

Track is divided into classifications: LRT only mainlines, Joint LRT and Freight/Passenger - use mainlines, Tracks in streets (street running), Yards, and Shops, and Stations.

3.1 Alignment and Clearance

3.1.1 General

3.1.1.1 Alignment

The track alignment shall be designed to maximize passenger ride quality at the highest permissible operating speeds. LRV maximum speed is based on PUC General Order 143-B. The design speed for the alignment shall be based upon the normal operating speeds as provided on speed-distance profiles generated from a train performance simulation program, constrained by maximum speeds through curves and stations, and areas where maximum speed is limited by stopping sight distance. Consideration shall also be made for locations where operations considerations make it likely that a train could be stopped or forced to operate at reduced speeds. Curves shall be designed to provide a smooth speed-distance profile, maximizing speed, and minimizing speed restrictions between stations.

Where two or more tracks are constructed along parallel alignments, one track may be designated the "stationed track." All horizontal stationing is directly related to the horizontal tangent, curve, and spiral lengths measured along the centerline of that track. The other track (or tracks) is constructed parallel to the stationed track, and the stationing is that of the stationed track and measured radially or normally thereto. Where tracks diverge, a station

equation will be placed at the point of divergence. Where diverging tracks come back together, the divergent stationing will be equated to the "stationed track."

Track gauge shall be a standard gauge of 4 feet 8-1/2 inches. The gauge is measured between the inner sides of the rail head 5/8 inches below and perpendicular to the top of rail (TOR). Track gauge can be widened for curves having a radius of curvature less than 150 feet with approval from SANDAG Director of Rail. The proximity to special trackwork shall be reviewed when considering a change in track gauge.

3.1.1.2 Clearance

The criteria developed in this section apply to the design of the entire system. All designs shall provide not less than the minimum clearances as specified in this section.

In addition to train clearances, the design engineer shall obtain current maintenance equipment dimensions and confirm adequate clearance for the rail maintenance of way (MOW) equipment.

3.1.2 Horizontal Alignment

The horizontal alignment of mainline tracks consists of tangents joined to circular curves by spiral transition curves. Spirals are generally not used in yards, service areas, other low speed tracks, and on large radius curves as identified in this manual.

Wherever possible, track geometry is designed for the design speed defined under this Section, which considers vehicle performance characteristics, station spacing, sight distance, and vertical and horizontal alignments.

3.1.2.1 Horizontal Clearances

Clearance shall be determined using the static and dynamic envelopes of the LRV as required by the CPUC, AREMA and these criteria. Dimensions for the static and dynamic envelopes for all SANDAG LRV models are shown in Figure 3.3. SANDAG's existing fleet of LRVs consists of Siemens Duewag Models U2, SD100, S70, and SD8 vehicles.

3.1.2.2 Minimum Clearances

Minimum distance between the centerline of tracks shall be generally spaced as follows:

- 14 feet 9 inches for exclusive or semi-exclusive LRT right-of-way with catenary poles installed between the tracks including the center walkway;
- 14 feet for joint use right-of-way with catenary poles installed on the outside of tracks;
- 12feet for LRT-only right-of-way with catenary poles and walkways installed on the outside of tracks;
- Where freight trains operate, the distance shall be in accordance with the requirements of CPUC General Order No. 26-D.

3.1.2.3 Standard Clearances

Standard distance between centerline of a track and obstruction on a tangent shall be generally spaced as follows:

- Absolute minimum of 5 feet 6 inches shall be provided from the centerline of track to any obstruction for LRT only territory, for obstructions less than 36 inches parallel to the track and higher than six inches above top of rail. Track mounted maintenance equipment shall be considered prior to inclusion of any limited or minimum clearances;
- Provide 8 feet from centerline of track to any obstruction greater than 36 inches parallel to the track and higher than the height of the trolley mirrors. Provide 7 feet 6 inches from centerline of the track to any obstruction greater than 36 inches parallel to the track and higher than 6 inches above top of rail. Obstructions include but are not limited to: retaining walls, cabinets and house, and fencing.

Figure 3-1. – Static and Dynamic Envelopes

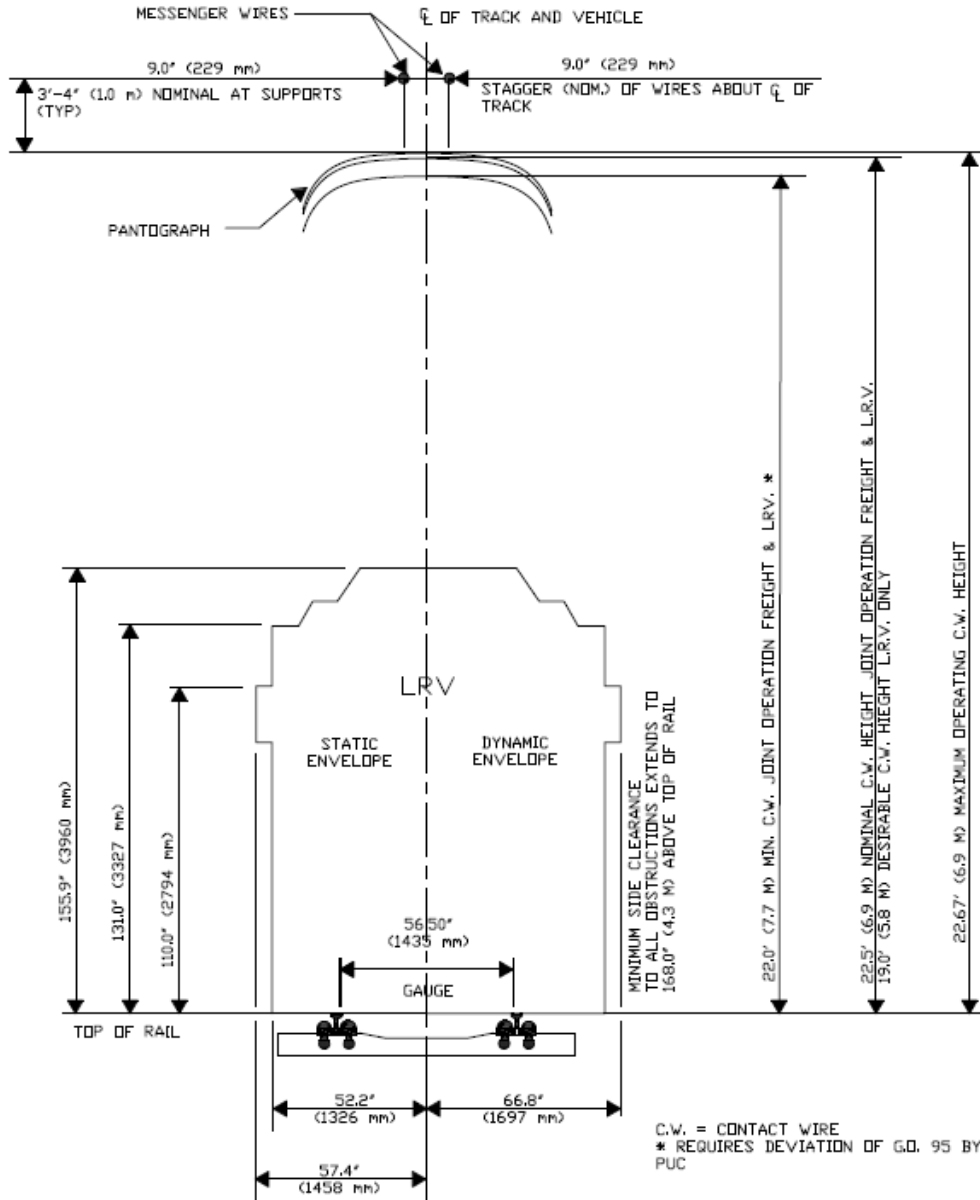

NOTES:

- FOR U2/SJ100, S70 & SDB VEHICLES
- BASED ON FLAT TANGENT TRACK WITH NEW RAILS
- BROKEN SUSPENSION SPRING ASSUMED FOR DYNAMIC ENVELOPE
- SEE G.O. 95 FOR MIN CLEARANCE REQUIREMENTS TO ENERGIZED CABLES.
- DIMENSIONS SHOWN REPRESENT THE LARGEST DIMENSIONS FROM THE U2, SJ100, S70 AND SDB VEHICLES

3.1.2.4 Adjustments

The horizontal clearance and track centers shall also include the following adjustments:

- Superelevation: Additional clearance to compensate for the tilt of the LRV to the inside of the curve:

$$E_c = \frac{E_a \times H}{60}$$

Where: E_c = Superelevation correction, inch

E_a = Actual superelevation, inch

H = Height on LRV, inch

Notes: LRV Height (Max.) = 155.9 inches

Walkway Height = 84 inches

- Vehicle In-Swing: Additional clearance to compensate for vehicle overhang at a point midway between the LRV trucks on the inside of a curve:

$$VI = 0.17 D_c$$

Where: VI = Vehicle in-swing, inch

D_c = Degree of curve, degrees

- Vehicle Out-Swing: Additional clearance to compensate for vehicle overhang at the end of the vehicle on the outside of the curve:

$$VO = 0.61 D_c$$

Where: VO = Vehicle out-swing, inch

D_c = Degree of curve, degrees

- Construction Tolerance: Additional clearance to compensate for track or associated facilities not constructed in their intended position. Use 1 inch for tracks and poles, and 1-1/2 inches for walls. When calculating clearances between two items to be constructed, the construction tolerances of each should be added.
- Maintenance Tolerance: Additional clearance to compensate for tracks that can shift under use. Allow 2 inches for ballasted track. No maintenance tolerance is necessary for direct fixation track.

3.1.2.5 Emergency Walkways

Walkways along Structures and Tunnels: An emergency/maintenance walkway shall be provided along structures and tunnels. There shall be at least one walkway adjacent to any track. The walkway shall be at or above Top of Tie (or top of plinth) and below TOR at the track edge for structures and at or above TOR (but no higher than 8 inches) at track edge for

tunnels. Both shall be located at a horizontal distance from track centerline as determined by regulations. The walkway shall have a minimum width of 30 inches.

Walkways along all Trackways: Emergency walkways between tracks required by Section 9.05 of CPUC General Order No. 143-B shall be 30 inches in width measured from the static envelope of the LRT vehicle, and extend 7 ft. 0 in. in height. The clearance requirements of Section 9.06 of CPUC General Order No. 143-B shall be based on the dynamic envelope.

3.1.3 Tangent Alignment

The minimum desired tangent length is 320 feet and minimum of 80 feet for LRT only track. If the tangent section is less than 80 feet, the spiral may be lengthened to run together with the approval of an exception from the SANDAG Director of Rail. For joint use trackage, the minimum tangent length shall conform to AREMA standard unless otherwise approved by the Director of Rail. If the spirals need to be lengthened, the spirals will be extended to provide a smooth reverse curve without a tangent segment between the reversing spiral curves. At stations, extend the tangent alignment a minimum of 75 feet beyond the platform in each direction.

3.1.4 Curved Alignment

3.1.4.1 Circular Curves

Circular curves are defined by the arc definition of curvature as specified by degree of curvature or radii. The relationship may be expressed as follows:

$$D_c = \frac{5729.575}{R} \text{ (English)}$$

Where: D_c = Degree of curvature, degrees

R = Radius, feet

Figure 3-2. – Circular/Spiral Functions and Abbreviations

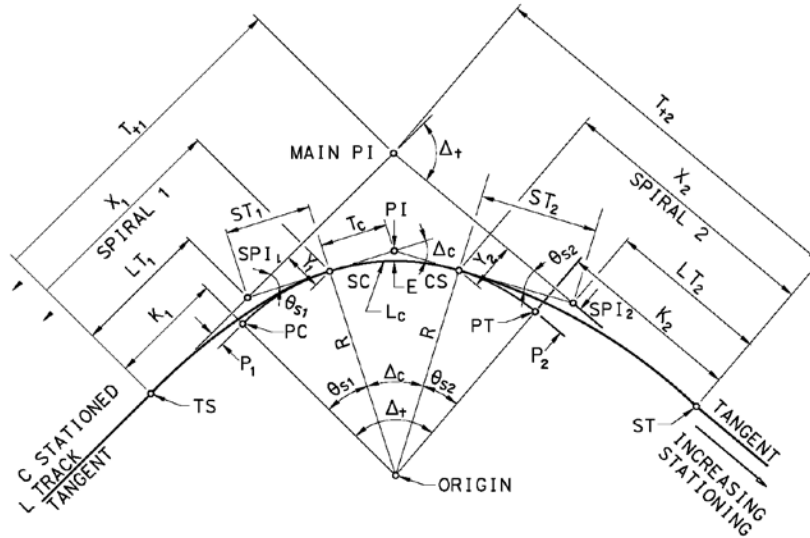

SPIRAL TRANSITION CURVES - CLOTHOID

NOTES:

1. THE TRACK PROFILE SHOWN IS THE ELEVATION OF THE TOP OF THE LOW RUNNING RAIL. THE PROFILE STATIONING IS THE SAME AS THE TRACK STATIONING MEASURED ALONG THE TRACK CENTER LINE.
2. THE SUPERELEVATION (E_s IN INCHES) IS THE VERTICAL DISTANCE OF HIGH RAIL ABOVE THE LOW RAIL MEASURED AT THE GAUGE LINE
3. SUPERELEVATION IS TRANSITIONED LINEARLY THROUGH THE ENTIRE LENGTH OF THE SPIRAL UNLESS OTHERWISE NOTED.
4. ALL CURVES DATA IS BASED ON ARC DEFINITION.
5. D_c , Δ_+ , θ_s , AND Δ_c ARE IN DEGREES.
6. NUMERIC SUBSCRIPTS REFER TO SPIRALS 1 AND 2.
7. ALL DISTANCES ARE IN FEET.

$$E = \text{EXTERNAL DISTANCE} = R = \text{EXSEC} \quad \frac{\Delta_c}{2}$$

$$L_s = \text{LENGTH OF SPIRAL}$$

$$\theta_s = \text{SPIRAL ANGLE IN DEGREES} = \frac{L_s \cdot D_c}{200}$$

$$d_s = \text{SPIRAL ANGLE IN RADIANS} = \theta_s \cdot \frac{\pi}{180}$$

$$n = \text{ANY POINT OF SPIRAL}$$

$$l_n = \text{LENGTH FROM TS TO POINT } n \text{ ON SPIRAL}$$

$$D_n = \left(\frac{l_n}{L_s}\right)^2 D_g$$

$$x = L_n \left(1 - \frac{d_n^2}{10} + \frac{d_n^4}{216} - \frac{d_n^6}{9360} + \frac{d_n^8}{685,440} - \frac{d_n^{10}}{76,204,800} + \frac{d_n^{12}}{11,975,040,000}\right)$$

$$y = L_n \left(\frac{d_n}{3} - \frac{d_n^3}{42} + \frac{d_n^5}{1320} - \frac{d_n^7}{75,600} + \frac{d_n^9}{6,894,720} - \frac{d_n^{11}}{91,806,640} + \frac{d_n^{13}}{168,129,561,600}\right)$$

$$X = x, \text{ WHERE } l_n = L_s$$

$$Y = y, \text{ WHERE } l_n = L_s$$

$$P = Y - R \cdot (1 - \cos \theta_s)$$

$$K = X - R \cdot \sin \theta_s$$

$$LT = X - Y / \tan \theta_s$$

$$ST = Y / \sin \theta_s$$

$$LC = \sqrt{X^2 + Y^2}$$

PI = POINT OF INTERSECTION
PC = POINT OF CURVATURE (OFFSET)
PT = POINT OF TANGENCY (OFFSET)
TS = TANGENT/SPIRAL POINT
SPI = SPIRAL POINT OF INTERSECTION
SC = SPIRAL/CURVE POINT
CC = CENTER OF CURVE
CS = CURVE/SPIRAL POINT
ST = SPIRAL/TANGENT POINT

$$D_c = \text{DEGREE OF CIRCULAR CURVE - ARC DEFINITION} = \frac{18000}{\pi \cdot R}$$

$$\Delta_t = \text{OVERALL DEFLECTION ANGLE}$$

$$\Delta_c = \text{CENTRAL ANGLE OF CIRCULAR CURVE} = \Delta_t - (\theta_{s1} + \theta_{s2})$$

$$R = \text{RADIUS OF CIRCULAR CURVE}$$

$$T_c = \text{TANGENT LENGTH OF CIRCULAR CURVE} = R \tan \frac{\Delta_c}{2}$$

$$L_c = \text{LENGTH OF CIRCULAR CURVE} = \frac{\Delta_c}{180} \cdot \pi \cdot R$$

$$T_t = \text{TANGENT LENGTH FROM TS TO MAIN PI} = K + (R+P) \tan \frac{\Delta_t}{2}$$

IF $\theta_{s1} \neq \theta_{s2}$:

$$T_{t1} = \frac{P_2}{\sin \Delta_t} - \frac{P_1}{\tan \Delta_t} + K_1 + R \cdot \tan \frac{\Delta_t}{2}$$

$$T_{t2} = \frac{P_1}{\sin \Delta_t} - \frac{P_2}{\tan \Delta_t} + K_2 + R \cdot \tan \frac{\Delta_t}{2}$$

3.1.4.2 Minimum Radii

The desirable minimum radius for LRT mainline track is 1,500 feet for 50 mph and 1,650 feet for 55 mph reaches. The desirable minimum radius for LRT in street running is 150 feet. The desirable minimum radius for secondary LRT tracks and for yard tracks is 250 feet. The absolute minimum radius a vehicle can negotiate is 90 feet. The maximum allowable curve radius for any given alignment should normally be utilized.

3.1.4.3 Minimum Length of Circular Curve

The desirable minimum length of a circular curve (excluding spiral transitions) is given by the formula:

$$L = 3V \text{ (English)}$$

Where: L = Minimum curve length, feet

V = Design speed through tangent, mph

Tracks are placed on concentric curves for multi-track alignments.

The length of the curve shall equal or exceed 1/12 the radius.

3.1.4.4 Spiral Transition Curves

Spiral transitions shall be used in mainline tracks to connect curves and tangents and to provide superelevation transition length for curves with radius less than or equal to 10,000 ft. For multi-track layouts, where tracks follow the same general alignment, and where the distance between track centerlines in the circular curve is the same as for adjacent tangents, the tracks are placed on parallel spirals. If the distance between track enters in the circular curve is different from that in the tangents, each spiral is a "true" spiral and its geometry is defined individually.

Figure 3-2 gives formulas and abbreviations for the spirals and curves used by SANDAG.

3.1.4.5 Minimum Length

The absolute minimum length for a mainline spiral is 50 feet where velocity is less than 35 mph. Where velocity is greater than 35 mph, the minimum length for spirals is 100 feet. The recommended length for spirals is the greater of the lengths given by the following formulas:

$$L_s = 30E_a$$

$$L_s = 1.22E_uV$$

$$L_s = 1.17E_aV$$

Where: L_s = Minimum spiral length, feet

E_a = Actual superelevation, inch

E_u = Unbalanced superelevation, inch

V = Design velocity, mph

3.1.4.6 Curves without Spirals

As a practical consideration, transition spirals for simple curves are omitted where the length for spiral (L_s) divided by the radius of circular curvature (R) using either feet or meters is less than 0.01. Where the spiral is not provided, the superelevation is attained over equal lengths of tangent and curve throughout the greater of the lengths given by the formulas in Section 3.1.4.5. One-half of the superelevation shall be developed on the tangent and one-half shall be developed on the curve.

3.1.4.7 Compound Circular Curves

Any compound curves will require the approval of the SANDAG Director of Rail.

Where compound circular curves are required, a spiral is inserted between the circular curves. The minimum length of such a spiral is the greater of the lengths as determined by the earlier formulas, modified as follows:

$$L_s = 30 (E_{a2} - E_{a1})$$

$$L_s = 1.22 (E_{u2} - E_{u1}) V$$

$$L_s = 1.17 (E_{a2} - E_{a1}) V$$

Where: L_s = Minimum spiral length, feet

E_a = Actual superelevation, inch

E_u = Unbalanced superelevation, inch

V = Design velocity, mph

Subscripts 1 and 2 denote first and second circular curves. Figure 3-3 gives compound circular curve formulas and abbreviations.

Figure 3-3. – Compound Curves and Combining Spiral Formulas and Abbreviations

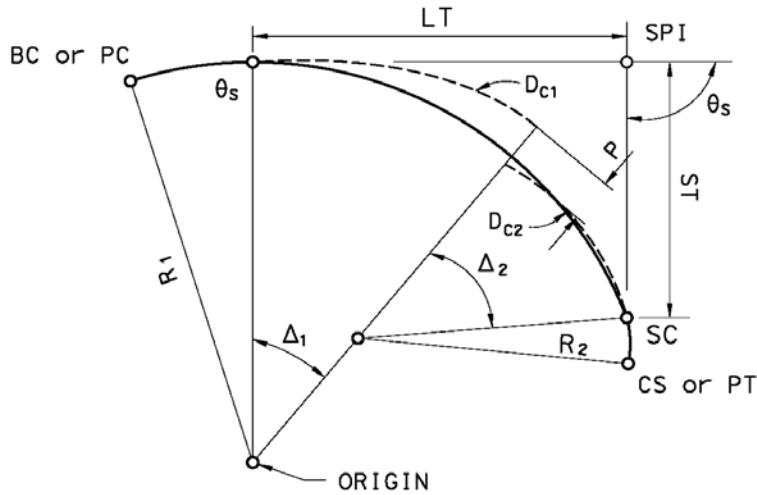

COMPOUND CURVES & COMBINING SPIRAL
FORMULAS & ABBREVIATIONS

- D_c = DEGREE OF CIRCULAR CURVE
- ST = SHORT TANGENT OF COMBINING SPIRAL
- LT = LONG TANGENT OF COMBINING SPIRAL
- L_s = LENGTH OF SPIRAL

$$\theta_s = \frac{L_s}{200} (D_{c1} + D_{c2}) = \Delta_1 + \Delta_2$$

$$\Delta_1 = \frac{L_s}{200} D_{c1}$$

$$\Delta_2 = \frac{L_s}{200} D_{c2}$$

$$\theta_a = \frac{L_s}{200} (D_{c2} - D_{c1})$$

$$R_a = \frac{18000}{\pi (D_{c2} - D_{c1})}$$

3.1.4.8 Superelevation

Superelevation of tracks is generally required for curves in mainlines, but not for low-speed tracks, such as secondary tracks and yard tracks.

The theoretical superelevation for equilibrium (E_r) can be expressed in terms of velocity as follows:

$$E_r = \frac{3.782V^2}{R} \quad (\text{English})$$

Where:

V = Actual velocity, mph

R = Radius of curve, feet

E_r = Theoretical superelevation, inch

Superelevation of the outer rail above the inner rail is required in horizontal track curves when the desired vehicle speed is greater than that which would provide a comfortable ride for passengers and equipment, and limit wear on vehicle wheels and the outer rails. In final design, the superelevation shall be set consistent with the design speed as described in Section 3.1 – “Alignment and Clearance”.

The total theoretical superelevation for equilibrium (E_r) assigned to LRT trackage is customarily comprised of two elements, one real and one imaginary. The first is the actual difference in rail elevations and is called "actual superelevation (E_a).” The second is an expression of the amount of superelevation that would be required to overcome a tolerable level of passenger discomfort, and is called "unbalanced superelevation (E_u).”

This results in the expression: $E_r = E_a + E_u$

Recommended maximum superelevation values are:

<u>Maximum LRT Only</u>	<u>Maximum LRT and Freight</u>
$E_a = 4$ inch	$E_a = 3$ inch
$E_u = 3$ inch	$E_u = 3$ inch
$E_r = 7$ inch	$E_r = 6$ inch

On LRT-only trackage, the actual superelevation may be increased to 6 inches with the approval of the SANDAG Director of Rail.

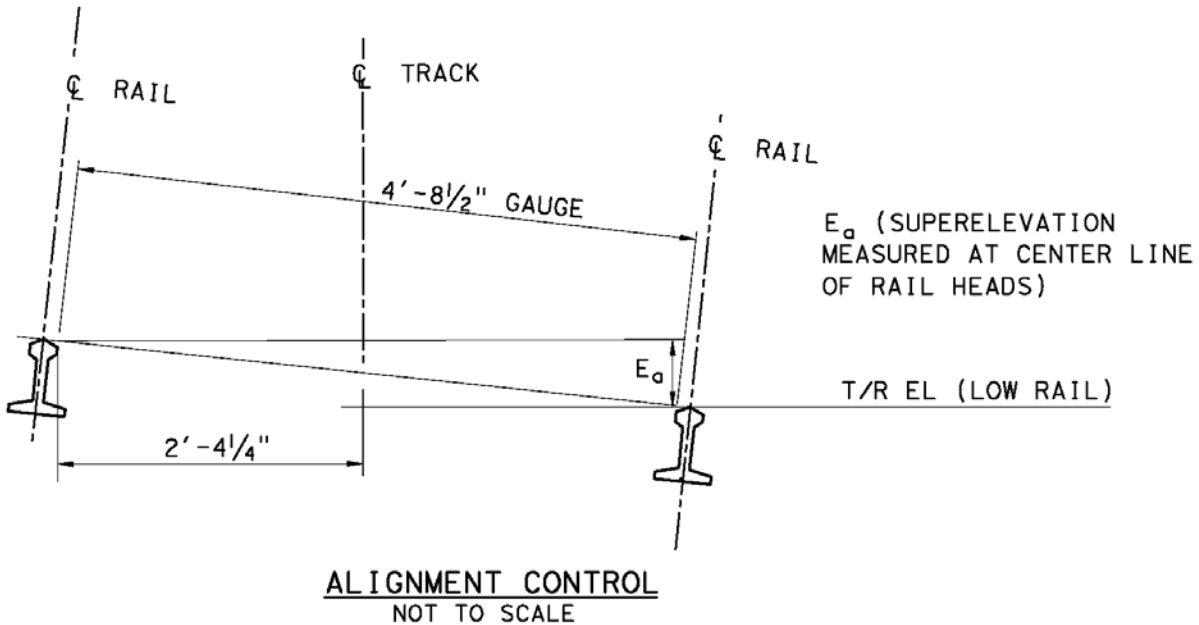
Figure 3-4. – Superelevation (E_a)

Typically, for track design, E_u would remain zero inch until the maximum E_a is used. The unbalanced superelevation E_u would be increased as necessary until the maximum E_u is used. If the design speed cannot be met at the maximum E_r , the curve radius may have to be lengthened, or the speed limited.

Actual superelevation is attained or removed linearly throughout the full length of the spiral transition curve. This is normally done by raising the rail farthest from the curve center while maintaining the top of the inside rail at profile grade. There are exceptions to the general rule that superelevation is held constant through the circular curve and is attained and removed in spiral transitions by raising the outer rail.

3.1.5 Vertical Alignment

Profile grade represents the elevation of the low rail. When only one track profile is given for curved alignment, the profile of the second track is adjusted uniformly to accommodate the difference in length through the curve. No compensation of grades is required for horizontal curvature.

All changes in grade are connected by parabolic vertical curves with a constant rate of change.

Stations and special trackwork, such as turnouts and crossovers, shall be located where both horizontal and vertical alignments are on tangent sections.

3.1.6 Vertical Grade

3.1.6.1 Grade Rates and Lengths

All grades should be the lowest percentage that is practical not to exceed 4.3 percent.

3.1.6.2 Mainline

The maximum design grade for any vehicle shall not exceed 4.3 percent without prior approval of the SANDAG Director of Rail. Where it may be beneficial to the design a constant grade of up to 6.0 percent may be allowed upon approval by the SANDAG Director of Rail if it is applied to a track length of 800 feet or less.

A minimum grade of zero percent is acceptable for at-grade construction, if drainage can be accommodated. A minimum grade of 0.50 percent should be maintained for underground and aerial structures to accommodate drainage.

The minimum length of constant grade between vertical curves shall be determined as follows:

$$L_g = 3V$$

Where: L_g = Minimum length of constant grade, feet

V = Design velocity through tangent, mph

The absolute minimum length of constant grade between vertical curves used in the design of new track shall be 100 feet.

3.1.6.3 Stations

A grade of 0.5 percent is the desired grade in all station areas, if drainage can be accommodated. The maximum grade through LRT stations is 2 percent except when stations are used for vehicle storage where the maximum grade shall not be greater than 0.3 percent.

Constant grade tangents shall extend 75 feet beyond the limits of station platforms.

Vertical curves through stations will be allowed only by approval from the SANDAG Director of Rail and where the curve is crested and no gradient through the vertical curve exceeds the maximum allowed under the constant grade criteria. A sag vertical curve will not be allowed in a station.

3.1.6.4 Yard and Secondary Tracks

For yard and secondary tracks in general, the minimum grade is usually specified as 0.20 or 0.30 percent and the maximum grade is typically 1.0 percent.

For storage tracks, a level grade is often desirable and 0.30 percent is the allowed maximum. Stub-end storage tracks shall slope away from the turnout, and through storage tracks shall have a sag in their profiles, otherwise derails shall be included in the design in accordance with the CPUC General Order No. 33B.

Turnback and center pocket tracks to be used for train storage and train consist changes should also be limited to a maximum grade of 0.30 percent where possible. Tracks located within a shop building should be set at a level grade.

3.1.7 Vertical Curve

All changes in grade are connected by parabolic vertical curves at crests and sags. The maximum vertical curve possible should be used where practicable.

3.1.7.1 Mainline

For mainline track, the absolute minimum length of vertical curve is 100 feet. For design of new and proposed LRT track, a desired minimum length of 200 feet should be used. This minimum shall not be exceeded without approval from the SANDAG Director of Rail. The desired length of mainline vertical curves above the minimum is determined by the following formulas:

- Crest: $L = \frac{V^2(G_1 - G_2)}{30}$
- Sag: $L = \frac{V^2(G_1 - G_2)}{60}$

Where: L = Length of vertical curve, feet

$(G_1 - G_2)$ = Algebraic difference in grades, percent

V = Design velocity, mph

The lengths of vertical curve are generally rounded up to the next even 50 feet length.

3.1.7.2 Ride Quality

- Both sag and crest vertical curves should be as long as possible, especially if connecting long constant-grade lines;
- The tops of rails and edges of aerial structures should be profiled to avoid a "rollercoaster appearance." Profiles plotted to an exaggerated scale are helpful in this analysis;
- Track construction tolerances shall be as specified by the Federal Railroad Administration (FRA) for a Class 6 railroad.

3.1.7.3 Stations

Vertical curves shall be located outside station platforms. See Section 3.1.6.3 – "Stations" for exception.

3.1.7.4 Compound Vertical Curves

Compound vertical curves may be used provided the requirements of this chapter are met, and prior written approval has been obtained from SANDAG.

3.1.7.5 Combined Vertical and Horizontal Curves

The designer shall consider the effect of horizontal and vertical curves on sight distance to signals, grade crossings, and stations.

The minimum combined (horizontal and vertical) curved section a four-vehicle train is capable of negotiating is as follows:

- 90 foot radius horizontal curve and 1640 foot vertical crest curve;
- 90 foot radius horizontal curve and an 1150 foot vertical sag curve; and

Combined horizontal and vertical curves shall not be more restrictive than these absolute minimum requirements.

3.1.8 Vertical Clearance

Vertical undercar clearance is defined from TOR with the maximum suspension deflection and car body roll, minimum vertical curve radius and fully worn wheels. Minimum vertical clearance under floor mounted equipment shall be 4 inches. Minimum vertical clearance truck mounted equipment shall be 3 inches. With the above conditions and with any radius curve, clearances between truck components and the car body shall be no less than 1.5 inches.

3.1.9 Joint LRT/Freight Rail Corridor

3.1.9.1 Freight Clearance

The LRT design criteria is based on Plate F Standard which meets all freight clearances for standard box cars and tankers. Automobile carrier cars exceed the clearances specified in this design criteria. Designer shall determine current and/or proposed future freight use prior to initiating design.

3.1.9.2 Freight Loading

Maximum loads for freight is 286,000 pounds.

3.1.9.3 Temporal Separation

Light Rail Vehicles may operate on the same railway provided there is Temporal Separation with FRA approval.

3.1.9.4 State of California

California Public Utilities Commission (CPUC)

The General Orders of the CPUC shall apply as follows:

- General Order No. 26-D - Clearances on Railroads and Street Railroads as to Side and Overhead Structures, Parallel Tracks, and Crossings;
- General Order No. 33-B - Construction, Reconstruction, Maintenance, and Operation of Interlocking Plants;
- General Order No. 52 - Construction and Operation of Power and Communication Lines for the Prevention or Mitigation of Inductive Interference;

- General Order No. 72-B - Construction and Maintenance of Crossings at Grade of Railroads and Public Streets;
- General Order No. 75-D - Protection of Railroad Grade Crossings;
- General Order No. 88-B - Rules for Altering Public Highway-Rail Crossings;
- General Order No. 95 - Rules for Overhead Electrical Construction;
- General Order No. 108 - Filing of Railroad Operating Department Rules;
- General Order No. 110 - Radio Communications on Railroad Operations;
- General Order No. 118-A - Construction, Reconstruction, and Maintenance of Walkways and Control of Vegetation adjacent to railroad tracks;
- General Order No. 128 - Construction of Underground Electric Supply and Communication Systems;
- General Order No. 131-D - Planning and Construction of Facilities for the Generation of Electricity and Certain Electric Transmission Facilities;
- General Order No. 135 - The Occupancy of Public Grade Crossings by Railroads;
- General Order No. 143-B - Rules for the Design, Construction, and Operation of Light Rail Transit Systems Including Streetcar.

California Public Utilities (CPU) Code

Any public transit guideway planned, acquired, or constructed, on or after January 1, 1979, is subject to regulations of the CPUC relating to safety appliances and procedures.

The CPUC will oversee major light rail line extensions and rehabilitation projects in accordance with the CPUC General Orders to ensure safety and compliance with General Orders in the design, construction, and commissioning of projects. Designer may be required to prepare safety certification plans, hazard analysis and prepare filings with the CPUC for review and approval.

Division of Industrial Safety (DIS)

The electrical orders in Title 8 of the Division of Industrial Safety, as applicable to trolley facilities (Chapter 4, Subchapter 5), shall be complied with in the development of design drawings and specifications.

Caltrans

Roadways and structures will follow Caltrans design standards and in accordance with Caltrans design procedures and standards.

- Standard Specifications (latest edition);
- Standard Plans (latest edition);
- Bridge Planning and Design Manual (latest updates).

State of California, Department of Energy, Title 24

Buildings shall be designed to maximize energy efficiency and in accordance with Title 24 and local building requirements.

State of California, Building Code, Title 24

Buildings shall be designed in accordance with Title 24 and local building requirements.

3.2 Mainline Track

New at-grade ballasted mainline track shall be constructed with continuous welded rail (CWR) on concrete ties and ballast. Direct fixation track shall be considered for at-grade conditions where appropriate. Direct fixation track shall be used in tunnels, bridges, and aerial structures where direct fixation provides a cost or maintenance advantage.

Conditions may vary along track alignment requiring modifications to standards set forth herein. Where designer determines modifications are recommended, the designer shall request approval as part of a basis of design report or request for deviation from this criteria.

3.2.1 Subgrade

Subgrade design shall be based upon the geotechnical report for the project developed as described in Volume 1 – Civil Work, “Geotechnical” Section. Issues for consideration include horizontal and vertical alignments, and typical sections, topographical features, drainage, and soil and rock data. Environmental concerns such as noise and vibration, erosion control, wetlands and contaminated soils should also be considered.

Subgrade design, whether cut or fill, shall be designed to support the loads imposed by both LRT and freight traffic without failure or excessive deformation.

The subgrade shall typically be sloped at 40:1 away from the center point located midway between the two tracks in double track territory. In single track areas, the subgrade shall slope toward a swale or underdrain system at 40:1.

Distance to subgrade hinge point from centerline of track shall be 10 feet 6 inches for a non-confined tangent trackway and 10 feet 10 inches for a non-confined curved trackway. Where trackway is confined subgrade shall be restricted to the confining limits.

Refer to Figure 3-5 for typical subgrade configurations.

Figure 3-5. – Typical Subgrade Configurations

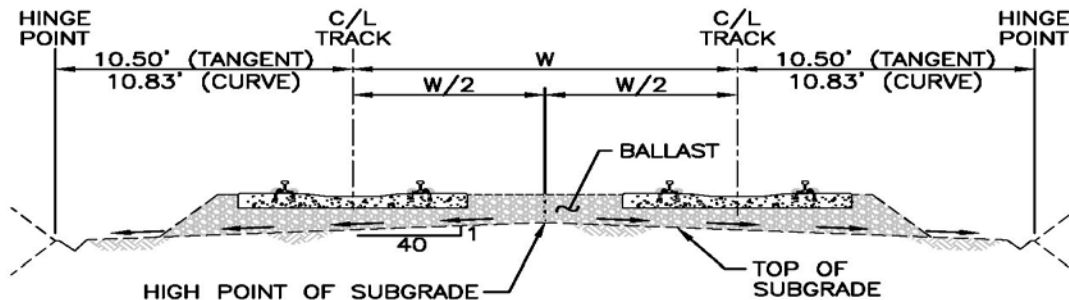

TYPICAL SUBGRADE – DOUBLE TRACK

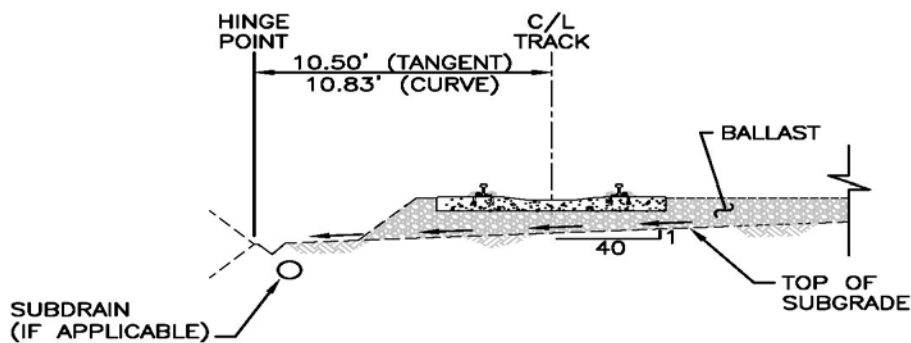

TYPICAL SUBGRADE – SINGLE TRACK

3.2.2 Geotextile Fabrics

For ballasted track on subgrade, non-woven geotechnical fabric is required between the ballast and the subgrade. For ballasted track on sub-ballast, the geotechnical engineer shall determine if geotechnical fabric is required between the sub-ballast and the subgrade. Fabric will extend the entire interface zone between the ballast and subballast (or subgrade). Fabric shall extend 6 feet minimum on both sides of the centerline of the track. Geotextile fabric specifications shall be as recommended by a Geotechnical Engineer. Overlaps of fabric shall be 24 inches minimum. The minimum weight of filter fabric material shall be recommended by the geotechnical engineer.

3.2.3 Sub-Ballast

All new trackbeds shall be designed in accordance with AREMA Manual, Chapter 1, Part 2, Section 2.11, "Sub-ballast Specifications," using the loads by light rail vehicles and the quality of the proposed subgrade materials. The thickness of subballast, if any, shall be determined as a part of this structural section. In most situations, a minimum of 6 inches of subballast should be used as a barrier between the subgrade material and the ballast.

Sub-ballast, cement-treated base, lime, or cement-treated subgrade of other subgrade improvements shall be recommended by the designer and specified in the design based upon in situ testing and analysis.

3.2.4 Ballast

Ballast shall be crushed quarry rock, composed of hard, dense particles of an angular structure, providing sharp corners and cubical fragments. Ballast gradation shall conform to AREMA Size No. 3, 2" – 1-1/2". Ballast gradation for each size shall conform to Table 1-2-2, "Recommended Ballast Gradations," AREMA Manual, Chapter 1, Part 2 - Ballast.

Ballast depth will be a minimum of 9 inches below the bottom of tie. Ballast shoulder will be a minimum of 12 inches beyond the ends of ties on tangent and 18 inches curves having a radius equal to or less than 10,000 feet. Ballast shoulder shall have a downward slope of 2:1. The final elevation of ballast shall be 1 inch below the top of tie at the rail seat, when compacted.

3.2.5 Corrosion

To evaluate the potential effects of stray current, soil and water corrosion impact to underground metallic and concrete structures, and atmospheric corrosion conditions of above ground metallic structures, the designer shall identify all SANDAG facilities, foreign utilities, and other structures that could potentially be affected by corrosion within or adjacent to the project limits. Structures which may be affected by corrosion include, but are not limited to:

- Buried and on-grade metallic and reinforced concrete structures;
- Components of the traction power electrification system;
- Retaining walls;
- Bridges and viaducts;
- Tunnels;
- Pier and pile structures;
- Ferrous pressurized piping (water, fire water, sewage, etc.);
- Metallic pipes, casings, and other metallic structures;
- Hydraulic elevator cylinders;
- Underground storage tanks; and
- Trackwork components.

As directed by SANDAG, the designer shall:

- Ascertain the electrical and chemical characteristics of the soil and water environments in general accordance with applicable Caltrans Corrosion Guidelines, dated September 2003 Version 1.0 (or latest);
- Perform soil resistivity tests at various depths;

- Use the soil resistivity test results to evaluate soil properties and water content effects on structures;
- During geotechnical investigation soil samples should be collected and analyzed for chloride and sulfate content, for pH and resistivity. A site shall be considered to be corrosive if one or more of the following conditions exist for the representative soil and/or water samples taken at the site:
 - Chloride concentration is 500 ppm or greater
 - Sulfate concentration is 2000 ppm or greater
 - The pH is 5.5 or less.
- Prepare reports of findings and recommendations;
- Incorporate design practices employed by SANDAG to limit stray current in the contract plans and specifications (see Standard Corrosion Control below);
- Specify track-to-earth resistance testing every 1,000 feet in accordance with ASTM G-165. Provide track-to-earth resistance acceptance criteria. Maximum stray current, emanating from the LRT System during normal operations shall not exceed a consecutive target maximum range of 0.2 amperes per 1,000 feet of track;

Use traction power analysis to calculate negative rise. If the negative voltage rise exceeds 45 volts, the designer shall recommend other mitigation techniques to incorporate into the design.

3.2.5.1 Standard Stray Current Corrosion Control

- Locating substations within 250 feet of the tracks to reduce the electrical potential difference (See also Section 4.10.1) (locations located beyond 250 feet and where the consultant has determined the facilities may be adversely affected by electrical potential differences the designer shall provide recommendations for testing and mitigation);
- Energized rails shall not be grounded;
- Ties and direct fixation fasteners shall be isolated from the running rails;
- Bridges shall be designed with corrosion control measures and should have corrosion test stations in accordance with Caltrans standards;

The designer shall recommend which other SANDAG and utility facilities should be provided with corrosion control measures.

3.2.6 Concrete Cross Ties

Mainline tracks shall use reinforced, prestressed concrete cross ties conforming to the strength requirements in the AREMA Manual, Chapter 30, Section 4.4. The concrete ties shall be specified based on rail traffic for a service life of 30 years. Typical tie dimensions are approximately 8 feet 4 inches in length, 7.5 inches in height at the rail seat, and 10 inches in width at the base, and 7.5 inches in width at the rail seat. In addition, concrete cross ties shall provide for a rail seat with a 40:1 cant sloped towards the center of tie. These dimensions are

typical, but the ultimate design dimensions must be determined by the project designer and tie manufacturer. See Figure 3-6 for typical concrete cross tie configuration. (Note: this figure is for reference only and is not specifying an exact dimensioning of the cross tie).

Tie spacing shall be 30 inches on center for tangent track and 24 inches on center through curves with radii of less than 1,000 feet. Refer to the Standard Drawings for special tie spacing on approach or existing special trackwork, station platform, elevated structure, or tunnel. All concrete cross ties shall conform to AREMA specifications.

Figure 3-6. – Typical Concrete Tie Configuration (Dimensions Vary)

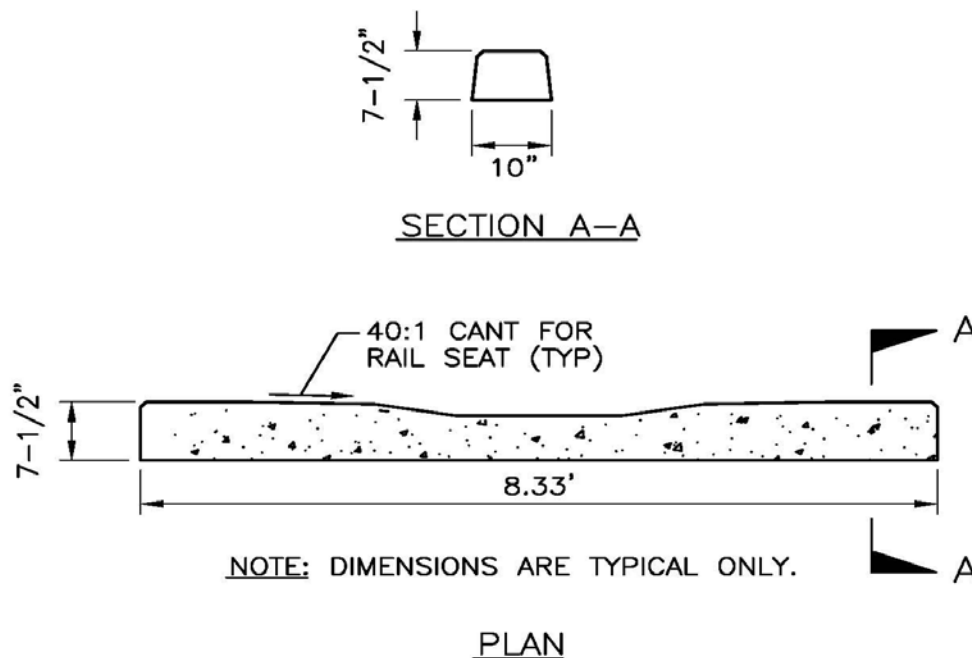

3.2.7 Timber Cross Ties

Timber Cross Ties shall meet the following criteria:

- Timber cross ties shall conform to the requirements of AREMA Manual, Chapter 30, Part 3. The cross ties shall be of pressure treated hardwood measuring 7 inches by 9 inches by 8 feet in length or greater in length depending on use and location;
- Requirements for tie fabrication, method of tie treatment and preservation, and tie handling and placement, including preservative materials, shall conform to AREMA recommended practices and shall be detailed in the procurement and/or construction contract documents;
- Bored holes shall be sized in accordance with AREMA requirements for cut spikes or lag screws;
- End plates shall be used on all timber ties;

- 10 feet timber ties with end plates shall be used at grade crossings.
Timber cross tie spacing shall be as follows:
- In tangent and curved tracks of radius greater than 500 ft. spacing shall be 24 inches center-to-center;
- In curves of radius less than 500 feet but greater than or equal to 300 feet spacing shall be 21 inches center-to-center;
- In curves of radius less than 300 feet spacing shall be 19.5 inches center-to-center.

3.2.8 Rail

3.2.8.1 Running Rail

New Rail for main line ballasted, embedded and direct fixation tracks shall be new 115 RE section, conforming to the current AREMA Manual, Volume I, Chapter 4, "Rail." Rail shall be either shop or field welded into continuously welded rail (CWR) lengths.

Rail for curves of 100 feet radii or less shall be pre-curved by a rail bending machine prior to being delivered to the site.

Designer shall include provisions for rail grinding. At the direction of the SANDAG project manager rail grinding may be specified for removal of surface imperfections and mill scale, optimize the rail wheel contact area, and facilitate traction power return and signal shunting, prior to initiating revenue service on a new line. Rail grinding patterns shall be designed in conjunction with consideration of alternative LRV wheel contours.

3.2.8.2 High Strength Rail

Unless otherwise directed by the SANDAG Project Manager, all Mainline Track shall be High Strength Head Hardened Rail conforming to AREMA, Volume 1, Section 2.1.4.2.

3.2.8.3 Restraining Rail

Restraining rails shall be used to provide continuous wheel support to LRVs negotiating sharp radius curves.

All mainline track excluding special trackwork with a centerline radius of 500 feet or less shall have inner restraining rail mounted adjacent to the low rail in accordance with AREMA plans and specifications. The flangeway width from gauge line of restraining rail to gage line of running rail shall be 1-7/8 inches. Restraining rail shall extend beyond the curve on both ends a minimum distance of 20 feet. Restraining rail shall be bolted. Restraining rail detail is shown on Figure 3-7.

Restraining rails on direct fixation open and embedded track shall be fastened to the running rail with direct fixation fasteners. A portion of the rail base of each restraining rail shall be removed on one side to avoid interference with the base of the running rail. Rail ends shall be predrilled for a 6-hole joint bar in accordance with requirements of AREMA Manual, Chapter 4, Part 1. Restraining rails shall be predrilled for bolting to running rail at 60 inches on center, and shall be furnished in minimum lengths of 39 feet. Restraining rail joints shall

be bolted together using D-bar installation. Restraining rail separator blocks shall be designed with shims to allow for future flangeway width adjustments due to wear.

All tracks having a centerline radius of 150 feet or less shall require both running rails to be installed with restraining rails.

Figure 3-7. – Restraining Rail Detail

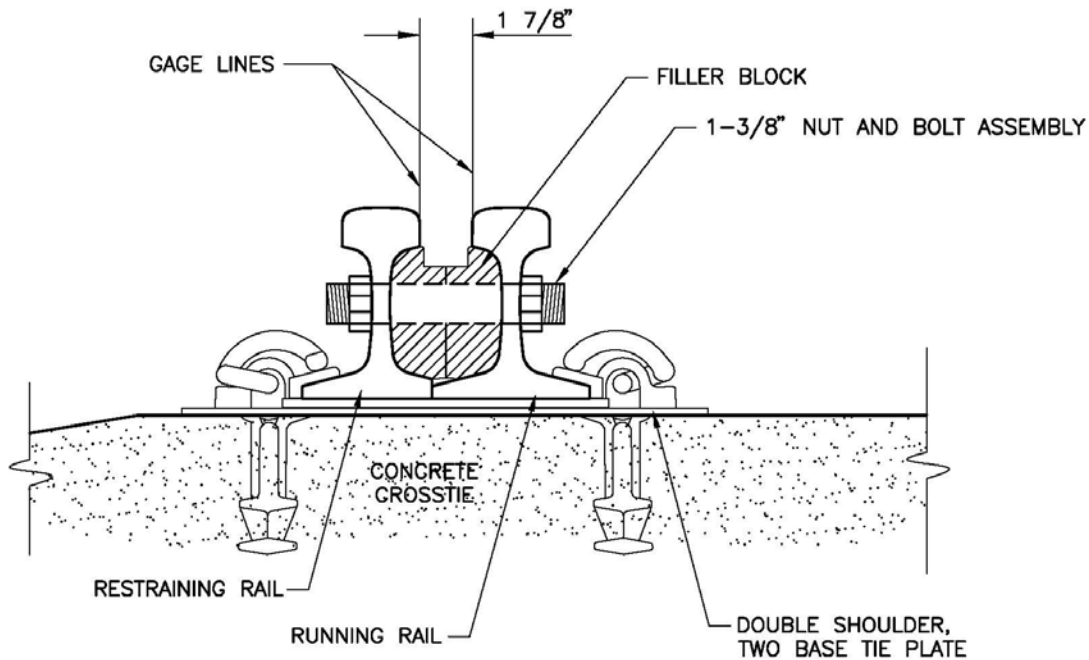

3.2.9 Rail Welding and Joints

All rail used for main and secondary track shall be joined by either flash butt or thermite welding process in accordance with Section 3.2.9.1 – “Continuous Welded Rail”.

Welded rail joints, on opposing rails, shall not be located at the same location but shall rather be staggered along the longitudinal axis. The staggering of welded rail joints shall be in accordance with the following criteria:

- Both welded rail and non-welded joints in opposite rails shall be staggered 10 feet minimum;
- Welded rail joints in and non-welded joints in rail used for turnouts shall be staggered 2 feet 6 inches minimum.

3.2.9.1 Continuous Welded Rail

All rails shall be continuously welded by either the electric flash-butt or thermite process in accordance with the current AREMA Manual, Volume I, Chapter 4, "Rail."

Continuously welded rail shall be de-stressed to zero thermal stress at $105^{\circ} + 10^{\circ}/-5^{\circ}\text{F}$ ($40^{\circ} + 5^{\circ}/-3^{\circ}\text{C}$).

De-stressing procedures shall conform to FRA requirements.

The use of temporary bolted joints during construction may be specified with the requirement that SANDAG reviews and approves the proposed method of trackwork installation and the welding procedures.

A program for testing welded joints shall be incorporated into the track installation contract specifications for acceptance.

3.2.9.2 Bolted (Non-Welded) Rail Joints

Bolted rail joints shall be placed only where required to accommodate LRT signal track circuits and connections to special trackwork. Bolted rail joints shall be electrically bonded to provide a continuous path for traction power negative return current and signal circuits.

All rail ends at rail joints shall be beveled and end hardened.

Bolted rail joints shall utilize 36-inches, 6-hole type joint bars using the heavy design criteria conforming to the current AREMA Manual, Volume I, Chapter 4, "Rail". Track bolts, nuts and lock washers shall also conform to AREMA standards.

3.2.10 Emergency Guardrail

Emergency guardrail shall be used on joint use freight and light rail track in accordance with AREMA standards. In light rail only track, the designer shall review the alignment and recommend the use of guard rail as needed. Emergency guardrail shall be designed for maximum vehicle speeds.

3.2.11 Rail Seats and Fasteners

The rail seats and fasteners shall hold the rail to the ties. Due to the negative return requirements, rail seats and fasteners shall also insulate the rail from the ground (see Figure 3-8). Rail anchors will not be needed or used. Other rail fastening methods shall be evaluated for street track, ballasted track and Special Trackwork.

3.2.11.1 Timber Crossties

Rail shall be secured to timber crossties using screw lagged tie plates and rail clips. Tracks in yards or existing spiked mainline track may have rail secured to timber crossties with tie plates and spikes. Tie plates shall have a 40:1 cant to the rail. Tie plates and spikes shall conform to the current AREMA Manual, Volume I, Chapter 5, Plan No. 7, Punch Pattern A.

Figure 3-8. – Typical Rail Fastener for Concrete Tie

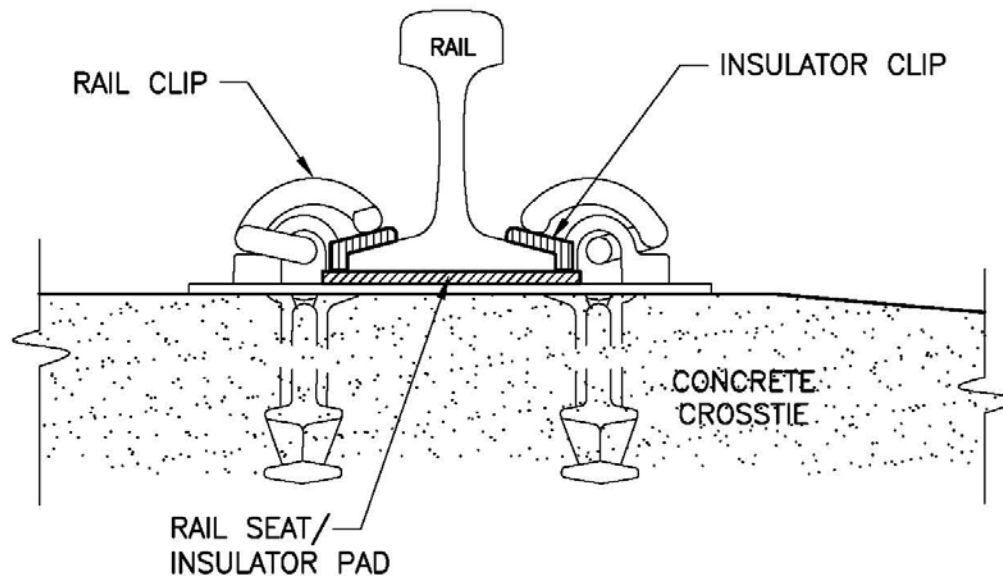

3.2.11.2 Concrete Crossties

Concrete cross ties will use with rail spring clips, isolated from the tie using plastic rail clip insulators, embedded rail clip shoulders, and elastomeric rail pads shall be used and placed on an insulating pad. Rail spring clips shall be secured to concrete crossties with Pandrol SRS FASTCLIP or e-clip type tie clips or approved equal. Elastomeric neoprene tie pads shall be used on the rail seats of the tie to protect against rail seat abrasion.

3.2.11.3 Direct Fixation

SANDAG uses three types of direct fixation track construction including on-slab, embedded, and plinth. Direct fixation shall be used on bridge aerial structures in accordance with Volume 1 – Civil Work, “Structures” Section, in tunnels, and on slab track sections. The designer shall specify direct fixation rail fastener assemblies including standard manufactures: track fasteners, insert assemblies, and Pandrol SRS FASTCLIP type of rail clips. Rail fastener assemblies shall be specified to be corrosion resistant using galvanized components where practical.

Fastener assemblies shall be placed on 30 inches centers for tangent track and 24 inches centers on curves.

Direct fixation rail fasteners shall provide the required lateral and longitudinal restraint for continuous welded rail (CWR) and the electrical insulation required for the negative return current and the proper operation of 60 Hz track signal circuits.

Direct fixation fasteners shall incorporate, or be placed on, a suitable elastomeric pad for reducing transmission of high frequency (i.e., greater than 30 Hz) loads to the support structure.

Rail fasteners for use in direct fixation special trackwork shall be of a design compatible with the standard fastener used in conventional direct fixation track.

Direct fixation fasteners shall provide a 40:1 cant of the rail.

Rail clips or other devices used in direct fixation fasteners shall produce the required longitudinal rail restraint after repeated load testing in accordance with AREMA Chapter 30, except load application angle in that test shall be 27 degrees.

The designer shall specify lateral and vertical adjustments tolerances for the contractor that preserve 50 percent of the fastener assembly adjustment for use by others in future adjustments of gauge and grade.

The designer shall recommend a method of rail stress distribution on structures, at tunnel portals and slab tracks, for approval by the project manager. Zero restraint rail fastener assemblies may be used when the design also provides for positive seating of the rail on the track fastener under service conditions.

Fastener assemblies shall be placed on concrete plinths on bridge aerial structures. Plinths may be used for other direct fixation conditions. Superelevation shall be accomplished on the plinths. Minimum and maximum plinth dimensions shall be determined by the designer and approved by SANDAG. The designer shall keep the plinth depths to minimum, but no less than 6 in. Plinths shall be designed to restrain the fastener under all loading conditions. Plinth reinforcing shall be designed to limit stray current from the rail to the main structural reinforcing steel of the structure or slab. Length of plinth sections shall be typically 9.5 feet on tangent and 7.25 feet on curves, and not less than 4.5 feet on tangent track and 5.25 feet on curved track. Spacing between plinth sections shall be 6 in. minimum.

Plinth curb shall be provided at transitions from ballasted track to direct fixation track on the structural abutment at the transition point interface. The plinth curb shall be oriented perpendicular to the rail and shall extend the full width of the structure. Where the transition occurs on a curve the plinth curb shall incorporate the required track superelevation. Provide drainage through plinth curb to accommodate anticipated flow.

3.2.12 Track Access

Right-of-Way access for LRT personnel and equipment shall be provided to the maximum extent possible and at every turnout and crossover. Areas shall be provided at or near these locations for the parking of maintenance vehicles.

Hi-rail access points shall be located on tangent track whenever possible. Access points shall be adequately secured to prevent unauthorized entry. Spacing of locations shall be coordinated with the rail operator.

3.2.13 Noise and Vibration

Noise and vibration shall be measured and mitigated, if necessary, in accordance with the environmental studies and the current FTA guidelines.

As directed by the SANDAG project manager wayside rail lubricators, using proven lubricants may also be utilized to provide reduction of airborne noise due to wheel/rail contact in sensitive locations.

3.3 Special Trackwork

Special trackwork includes turnouts, track crossings, wyes and crossovers. Special trackwork shall be designed, manufactured and installed in accordance with SANDAG guidelines and the current AREMA Manual except as modified to meet special conditions approved by the SANDAG Director Rail. Tolerances shall be in accordance with AREMA portfolio of Trackwork Plans. All frogs and flangeways shall be designed to accommodate an AAR wheel profile.

All special trackwork shall be located on vertical and horizontal tangents, except as approved by the SANDAG Director of Rail. The minimum length between any point of switch and a passenger station platform shall be 50 feet. Except as approved by SANDAG Director of Rail, special trackwork shall not be placed inside station limits. The minimum horizontal distance from any point of switch to any physical constraint (i.e., grade crossing, bridge deck, etc.) shall be 10 feet.

Special trackwork shall be designed to facilitate operations and maintenance. Final location of special trackwork shall be reviewed with the operator and approved by SANDAG. Two single crossovers shall be used instead of double crossovers unless space restrictions dictate a double crossover. Special trackwork shall not be placed on bridges or elevated structures that are less than 1,500 feet in length or as approved by the SANDAG. Special trackwork in paved street running track shall be kept to the minimum needed to meet operational requirements including single tracking and reverse running. Special trackwork in street running track shall be paved and with rubber/rail interfaces at least on the gauge side of rails to form the flangeway. Switch points and switch machines shall be surrounded by galvanized steel boxes designed to allow for full motion of switches when pavement is placed up to the boxes. The boxes shall be designed to reduce exposure to the operating mechanisms. Special trackwork in paved street running track shall not be located within 20 feet of an intersection, measured from the projected face of curb of cross street through the intersection or in an area where traffic could legally cross the special trackwork.

Special trackwork shall be all new material in accordance with the requirements of AREMA plans. Turnouts and crossovers shall match the 115 RE rail profile. Turnouts and crossovers shall include switch rails, stock rails, closure rails, special plates, gauge plates, points, blocks, manganese turnout frogs, crossing diamonds, guardrails, and all other parts necessary for a complete installation.

Turnouts and crossovers shall have insulated assemblies. Turnouts shall be designated right hand or left hand. Typical turnout usage is as follows:

- No. 20 turnouts (39 feet curved split switch points) shall be used on mainline ballasted track at specific locations where high speed operations is essential;
- No. 10 turnouts (19 feet 6 inches curved switch points) shall be the minimum standard on all mainline track;
- No. 8 turnouts (19 feet 6 inches curved switch points) shall not be used unless approved by the SANDAG Director of Rail;
- No. 6 turnouts (11 feet straight switch points) shall be used in the yard or in storage track areas only.

The designer shall evaluate the site conditions and recommend the tie material, spacing, and components. The final determination will be made by the SANDAG Project Manager with concurrence by MTS. Special trackwork shall be placed on hardwood timber /concrete switch ties spaced as shown on turnout, crossover or crossing diamond drawings. Switch ties shall typically be 7 inches in depth by 9 inches in width pressure-treated hardwood. The length and number of switch ties shall be as shown on standard plans for Special Trackwork. Where approved by the SANDAG Director of Rail, special trackwork installed on concrete elevated structures or in tunnels shall be placed on plinths or concrete slab by direct fixation using standard components. Switch points for primary and secondary tracks shall be as per AREMA Detail 5100, Plan 221-08.

All mainline frogs shall be equipped with appropriate guard rails. Yard frogs shall be self-guarded. Spring frogs, flange bearing frogs, lift-over frogs and other special frog configurations shall be approved by the SANDAG Director of Rail.

Necessary drainage provisions shall be made in all street turnouts to preclude standing water in flangeways, tongue areas, and in switch-throwing mechanisms. Special trackwork is a source of noise and vibration, therefore its location shall be selected to minimize these effects.

3.4 Other than Mainline Track

Track other than main line track includes yard track, secondary track, and shop track.

3.4.1 Yard Track

All yard track criteria shall conform to the mainline track criteria except as follows in this section.

3.4.1.1 Ballast

No. 5 ballast conforming to AREMA Manual, Volume 1, Chapter 1, Part 2, "Ballast" specifications shall be used on all yard tracks.

A minimum depth of 8 inches of ballast shall be used between the bottom of the tie and the top of subballast. The top of the ballast elevation shall be 1 in. below the base of rail and the ballast shoulder shall extend beyond the ends of the ties to form a suitable walking surface.

3.4.1.2 Cross Ties

Yard tracks shall use only timber cross ties as described in Section 3.2.7 – “Timber Cross Ties”. Spacing of cross ties for yard track shall be as follows:

- In tangent and curved track of radius greater than or equal to 500 feet: 30 inches center-to-center;
- In curves of radius less than 500 feet but greater than or equal to 300 feet: 24 inches center-to-center;
- In curves of radius less than 300 feet: 21 inches center-to-center;
- For special trackwork spacing shall be spaced per the standard plans.

3.4.1.3 Rail

All rails in the yard tracks shall be new 115 RE section, conforming to the current AREMA Manual, Volume I, Chapter 4, "Rail." Rail shall be welded to the longest strings possible by either shop or field welding process. Rails shall be jointed where welding rail is not practical for construction and handling.

3.4.1.4 Restraining Rail

All yard tracks with a centerline radius of 100 feet or less shall have inner guard restraining rails mounted adjacent to the inside rail in accordance with AREMA plans and specifications.

3.4.1.5 Rail Joints

Standard bolted rail joints may be used to connect switch points, sections of emergency guard rail, restraining rail, or running rail and special trackwork in yard. Rail ends shall be beveled, hardened and drilled for joint bars in accordance with AREMA Manual, Volume 1, Chapter 4, Part 1, “Design”, Section 1.3

Rails joined with standard bolted joints shall have a gap between rail ends in accordance with the requirements of the AREMA Manual, Volume 1, Chapter 5, Part 5, “Track Maintenance”, Section 5.1.

Bolted joints in running rails shall be electrically bonded to provide a continuous path for traction power negative return current and signal circuits, if applicable.

3.4.1.6 Special Trackwork

All yard turnouts shall be No. 6 with 11 feet straight switch points conforming to AREMA Point Detail 5100, plan 221-08, with graduated risers. Self-guarded frogs shall be used. Special Trackwork shall match the 115 RE profile.

3.4.1.7 Paved Trackwork

Trackwork within the limits of the yard where personnel and equipment access is frequently required shall be paved. Concrete or asphalt may be used and placed on top of ballasted trackway to the top of rail with provisions for wheel flangeways (See MTDB Standard Plans, ST-07).

3.4.2 Shop Trackwork

Shop trackwork shall be installed within the limits of the maintenance shop building. This type of installation shall be similar to the embedded trackwork except in pit areas. In shop pit area, steel girders installed longitudinally beneath the rail and fastened with crane rail clamps or similar rail fasteners shall support each rail.

3.4.3 Bumping Posts

Sliding type bumping posts shall be installed at the end of each operating track with temporary or permanent stub ends. A bumping post equipped with shock absorbing or cushion head may be installed with prior SANDAG approval. The bumping post shall be designed so as to engage the anti-climber or end sill of the LRV without any portion of the bumping post interfering with the LRV coupler, regardless of its position. The design of the bumping post shall provide the following:

- Bumping posts shall be of one (1) type, suitable for installation in ballasted or direct fixation trackwork;
- Bumping posts shall be able to withstand a striking force of 60,024 pounds minimum.

3.5 Highway-Railway Crossings

A highway-railway crossing shall be defined as any public or private accessible area, such as a city street, city sidewalk, or private drive, where non-rail traffic is allowed to cross the tracks at the same grade.

Design of all vehicular or pedestrian traveled ways, approaching a highway-railway crossing, unless otherwise noted, shall be in accordance with the current specifications and design guidelines of the applicable local jurisdictions, California Public Utilities Commission (CPUC) General Orders, AREMA Chapter 5, Part 8, California Manual on Uniform Traffic Control Devices (CMUTCD) Part 8, United States Code of Federal Regulations Title 23 Part 646 Subpart B, and the diagnostic team's requirements (see Volume 2, Section 5.4). For those cases where the local jurisdictions have no design guidelines, the Caltrans Design Standards shall be used. Design shall also be in conjunction with Section 5.4 - "Grade Crossing Warning Systems".

Designer shall take into consideration the potential for vehicular and pedestrian traveled way widening when designing a highway-railway crossing and be incorporated into the design for future application. Where vehicular and pedestrian traveled way widening is proposed the designer shall coordinate with the governing agency.

Highway-railway crossings shall be located on ballasted, tangent track, away from special trackwork unless otherwise approved by the SANDAG Project Manager. Only monolithic segments of rail shall be placed through a grade crossing. Rail joints and thermite welds shall not be located within a grade crossing.

Grade crossings shall incorporate the use of pre-fabricated durable materials including pre-cast concrete panels or with the approval of the SANDAG Project Manager, rubberized panels, placed between and adjacent to the running rails including installation of panel end restraints. Panels shall be removable to allow for track maintenance and provide ease of

reinstallation. Consideration shall also be given to electrical isolation, non-interference with electrical track circuits or rail fastenings, vehicle tire traction and ride comfort, and slip resistance for pedestrians.

Cross tie size and spacing shall be analyzed for all highway-railway crossings based on both LRV loads and traffic loads.

3.5.1 PUC Requirements

- General Order No. 72-B - Construction and Maintenance of Crossings at Grade of Railroads and Public Streets;
- General Order No. 75-D - Protection of Railroad Grade Crossings;
- General Order No. 88-B - Alteration of Existing Grade Crossing of Public Roads, Highways, and Streets with Railroads;
- General Order No. 135 - The Occupancy of Public Grade Crossings by Railroads.

4.0 TRACTION POWER

These criteria govern the design, installation, and performance requirements of the major traction power system elements, including the traction power substations, DC distribution system, and overhead catenary system and its supports.

All elements of the traction power systems shall use service-proven technologies that are readily available and off the shelf. Proprietary equipment systems shall be avoided where possible.

Traction power systems shall be designed in accordance with California Public Utility Commission, General Order 95 requirements and, except as otherwise described in this section or shown in the standard plans, applicable recommended practices described in the American Railway Engineering and Maintenance of Way Association (AREMA), Manual for Railway Engineering, Volume 3, Chapter 3: Part 2 “Clearances” (section 2.2); Part 4 “Railroad Electrification System”, and IEEE Guide for Rail Transit Traction Power Systems Modeling, Standard 1653.3 and IEEE Standard for Supporting Structures for Overhead Contact Systems for Transit Systems, Standard 1630.

In areas where both freight trains and light rail vehicles will operate over the same tracks the OCS support structures shall conform to the minimum clearances described in California Public Utility Commission, General Order 26-D except that the contact wire may be located within the clearance envelope at a height of not less than 22 feet. SDTI has a deviation granted by the CPUC for this contact wire height.

In areas where only light rail vehicles will only operate over the tracks the side clearances and emergency egress walkways shall conform to the minimum requirements described in California Public Utility Commission, General Order 143-B.

Definitions:

Unless otherwise defined in this section of the design criteria, all of the terms listed in the AREMA “Manual for Railway Engineering” Chapter 33 Glossary shall be utilized as definitions. In addition the following descriptions shall be used to define the following terms:

- **Ambient Temperature:** Outside air temperature at location of assembly or equipment to be set to a specified setting based on measured air temperature value.
- **Catenary Suspension:** Same definition as Catenary as defined in the AREMA “Manual for Railway Engineering” Chapter 33 Glossary.
- **Centerline of Track:** Is the line drawn perpendicular to the top of the running rails along the centerline of track and perpendicular to the trackway.
- **Joint Use Track:** A segment of track over which freight and Light Rail operate.
- **Line Fault (Traction Power System):** A low resistance electrical connection enabling current to flow directly between the positive traction power system conductor(s) and the negative traction power system conductor(s) without passing through the light rail vehicle traction power motors and control circuits.

- **Midspan Offset:** Is the distance from the superelevated centerline of track to the contact wire measured parallel to a line drawn perpendicular to a rail from the top of the rail to the top of the adjacent running rail of a single track.
- **Multiple Operating Line Segment:** A segment of track over which two or more Light Rail lines operate. The complete turnout and diamonds where the line segments merge on to the same track are included in the Joint Operation Segment.
- **Plumb-bob:** Is tool composed of a conical metal weight suspended from a string and used to establish a vertical reference line.
- **Power Section:** A segment of the overhead catenary contact and traction power feeder system that extends from a traction power substation (TPSS) to the adjacent TPSS and power is typically supplied from both ends.
- **Single Operating Line Segment:** A segment of track over which one Light Rail line operates. The turnout and diamonds are not included in the non-joint operation segment.
- **Standard System Depth:** The vertical distance measured along Vertical Plumb Line between the catenary system messenger and contact wires at support points in locations other than overlaps, transitional areas, and crossovers.
- **Supervisory Control and Data Acquisition (SCADA):** A digital information networked computer system that monitors and acquires equipment and system status, alarm, data (e.g. voltage, current, energy consumption, reactive power), and indication information and enable command(s) to be sent to field programmable logic controller(s) (PLC) and device(s) that respond to command(s) with prescribed action(s) taken by the device(s).
- **System Depth:** The vertical distance measured along the Vertical Plumb Line between the catenary system messenger and contact wires at support points.
- **Transfer Trip:** Act of controlling the opening of remote direct current (DC) breaker(s) in adjacent traction power substation(s) (TPSS) feeding the same Power Section when a DC breaker feeding the same Power Section trips (opens) as a result of a detected traction power system (TPS) Line Fault.
- **Vertical Plumb Line:** A vertical reference line established using a Plumb-bob.

4.1 Environmental Requirements

All systems shall be designed to operate given the environmental conditions indicated herein.

Ambient Temperature:

Highest:	115 degrees F (46 degrees C)
Lowest:	15 degrees F (-9 degrees C)
Yearly Average:	70 degrees F (21 degrees C)
Humidity:	10 to 100 percent

Precipitation:	4 inches (10 cm) in 24 hours and 1.5 inches (4 cm) in one hour
Ice Loading:	None
Seismic Zone (UBC):	4
Maximum Wind Velocity:	As described in the latest edition of the California Building Code (CBC)
Maximum Wind Velocity for Train Operations:	56 mph (25 m/s)
Atmosphere (typically):	Coastal Environment
Weather (typically):	Sunny
Lightning (Isokeraunic level):	5 per Year

4.2 Applicable Documents

All assemblies and components included in the design, manufacture, and installation of the traction power system shall conform to the latest editions of the standards listed in Volume 1 – Introduction, “Governing Regulations and Laws” Section and applicable standards of the following agencies or organizations:

- American National Standards Institute (ANSI);
- American Railway Engineering and Maintenance of Way Association (AREMA);
- National Electric Code (NEC);
- State of California Electrical Safety Orders;
- Insulated Cable Engineers Association (ICEA);
- Institute of Electrical and Electronics Engineers (IEEE);
- National Electrical Manufacturers Association (NEMA).

4.3 Standard Plans

SANDAG maintains Standard Plans for the traction power system design. The designer shall utilize the latest version of the SANDAG Standard Plans where applicable. Where the Standard Plans do not cover a specific type of application, the designer shall submit additional drawings to SANDAG for approval. SANDAG is currently working on a standard plan update.

4.4 Acceptance Testing and Measurements

The designer shall include in the Special Provisions detailed testing procedures, submittal criteria, and acceptance criteria for each of the tests specified. The designer shall also specify that the contractor shall submit a Test Plan, Testing Procedures, and Test Data forms for

approval by the SANDAG Construction Manager a minimum of 60 working days prior to the scheduled start of the test.

The designer shall specify that:

- The test plan and procedures shall be in accordance with all requirements of the standards of the governing agencies;
- The contractor shall notify the SANDAG construction manager of the location, date, and time that testing will be performed a minimum of five working days in advance of the actual testing;
- The contractor shall set up for testing in advance of the actual testing;
- The contractor shall include complete details of test results and corrections or adjustments performed on the traction power system during testing and all items to be corrected with the final test results report;
- The contractor shall submit the results of each of the tests within 20 working days following each test.

The designer shall specify additional acceptance measurements to be taken by the contractor for contract acceptance. The list of acceptance measurements to be taken by the contractor shall be submitted by the designer to the SANDAG project manager for approval with the 65 percent submittal.

4.4.1 Test Documents

The designer shall specify that at least six copies of each test document shall be submitted to the SANDAG construction manager and that the documents shall be approved prior to testing. The designer shall also specify that six sets of all revisions to the test document shall be submitted to the SANDAG construction manager.

4.4.2 Test Plan

The test plan that is prepared by the contractor shall be used as a controlling document for all tests and shall include the following information:

- The title of each test with reference to the respective article or section number in the Special Provisions;
- The organization performing each test;
- The test location;
- The submittal date of each test procedure, test report, and/or certified test document;
- The starting date of each test;
- The completion date of each test.

4.4.3 Test Procedures

Test procedures shall be developed by the Contractor and conform to the following minimum requirements:

- Title of the test, date, and name of individuals who prepared and approved the procedure;
- Test objectives;
- Test location and date of the test;
- Equipment and instrumentation with the accuracy and calibration data;
- Governing standards and test methodology, including test setup with circuit diagrams and test sequence;
- Test pass/fail criteria, including data evaluation procedures;
- Test data requirements, including forms and format for recording data.

4.4.4 Test Reports

The test reports that are prepared by the contractor for each test shall document the results of the test. The test report shall contain the following:

- Title, date, and location of the test;
- Name of individuals who prepared and approved the report;
- Test objectives;
- Test data forms with signatures of test witnesses;
- Observations and additional data, including tables and photographs;
- Descriptions of failures and modifications;
- Abbreviations and references;
- Summary and conclusions.

4.4.5 Field Test Categories

The following types of field tests, listed in no particular order, shall be specified when applicable to the scope of work.

- Soil Resistivity Tests using the Wenner method indicated in IEEE 81-2012;
- Grounding Resistance Tests of catenary pole grounding, and of substation grounding system;
- Power Circuit Continuity Tests (positive and negative return sides) performed on each of the test sections between adjacent traction power substations of the project;
- Dielectric Tests performed on each of the OCS test sections between substations;

- High Potential Test of all feeder cables at voltages and for time durations in accordance with ICEA recommendations;
- OCS/LRV Clearance Test;
- Substation Short-circuit Test (Ground Fault Test);
- Train Starting Tests for calibration of dc current rate-of-rise protective relays;
- AC and DC Protective Relay Settings Verification;
- Substation Equipment Integrity and Functional Tests;
- Substation Noise Level Tests, interior and exterior.

Test equipment calibration requirements and additional testing requirements shall be added by the designer to the Special Provisions, as needed, to ensure a safe and operational system.

4.5 Compatibility with the Existing Systems

All extensions of the traction power system shall be fully compatible with the existing 650 volt nominal DC system.

4.6 Energized System

The designer shall specify that no work be performed on an energized traction power facility unless the Contractor's qualified lineman is authorized to do so by San Diego Trolley, Inc. (SDTI), staff and the SANDAG Systems Engineer on a task and site specific basis. The plans, special provisions, and cost estimate shall include safety requirements, detailed work plan requirements, and requirements for maintaining operation. All work performed on high voltage (600 volts or higher) energized structures shall meet the requirements including but not limited to Cal OSHA and the California Electrical Safety Orders.

4.7 Technical Design Reports

The traction electrification system (TES) designer shall perform a dynamic load flow study to support the TES design decisions, and all the work necessary to create and submit a written traction power report to SANDAG containing:

- Executive summary including key results and recommendations;
- Study approach;
- Transit system data and assumptions for the computerized model, including track alignment and stations; speed limits; vertical profile; essential data for the TES such as parameters and locations of the traction power substations; overhead contact system (OCS) wire sizes and sectionalization; dc feeders' sizes, lengths and connection points; negative return system details, etc.;
- Design criteria requirements;
- Analysis of simulations results and key findings

The analysis of simulation results shall contain, at a minimum, the follow conclusion information:

- Worst-case minimum train voltages between the substations. For the contingency operations with a substation out-of-service, if the worst-case minimum train voltage is below the minimum acceptable, the report shall also provide the probability of the train voltage falling below the minimum acceptable level, calculated per methodology described in Sec. 4.8.5 below;
- Maximum running rails to ground potentials values;
- Maximum Root Mean Square (RMS) load current values in the substations' feeders;
- Maximum RMS and momentary current values through the substations' transformer/rectifier units;
- Thermal capacity evaluation and maximum temperature values of the overhead contact system (OCS), assuming worst-case environmental conditions and worst-case normal and contingency operations of the TES, to ensure there is no danger of overheating (especially annealing) of the contact and messenger wires, and no hot spots.

4.8 System Design Requirements

The traction electrification system (TES) shall be designed to support normal train operations with the required consist sizes and headways, with any one traction power substation (TPSS) being out of service. In the outage zone around the out-of-service TPSS it shall be assumed that the trains are still run normally, at maximum power level by the train operators, without intentional reduction of acceleration or speed.

Traction Power and Overhead Contact System computer aided drawing files shall be provided by the designer to SANDAG Systems Configuration Manager. The Construction Contractor shall update design drawings with as-built information and submit final drawings for the installed system.

4.8.1 Operational Criteria

Unless otherwise indicated by the train operations plan used for the design or upgrade of a specific line, the TES shall be designed to support the following operational criteria:

Design headway, peak period:	As specified by SANDAG/MTS
Station dwell time:	30 seconds in Downtown, 20 seconds elsewhere
Train passenger load:	AW2
Train consist:	4 cars per train
Layover at end of Line:	5 minutes
Duration of the peak period:	3 hours

4.8.2 Minimum Voltage Criteria

The train voltage is measured between the contact wire and running rails at the train, as the average voltage over the rectification cycle.

The traction electrification system (TES) comprising traction power substations, overhead contact system (OCS), running rails used for negative return, and dc feeders shall be designed to satisfy the following voltage requirements:

- Light (0.5 percent) load voltage at the TP substations: 690 volts dc (assuming nominal primary voltage from the utility system and neutral tap of the rectifier transformer);
- Minimum voltage at the trains for normal TES configuration and normal train operations (no train bunching) shall be above 420 volts DC for any directional timing offset (DTO) between trains moving in the opposite directions on the same line;
- In contingency operations with a traction power substation (TPSS) out of service, minimum train voltage below 420 V dc is acceptable provided the probability of the voltage falling below 420 V dc, as a function of the DTO between trains on the opposing tracks, is less than 10 percent. The load flow study for determining the worst-case minimum voltage and related probability of occurrence for the voltage falling below 420 V dc shall be based on multiple simulations with different DTOs, referred to as statistical run, as explained in Section 4.8.5.

4.8.3 Criteria for Contingency Operations

Contingency operations for the purpose of a traction power load flow study and TES design are defined as operations with one TPSS out of service. It is also assumed that such contingency involves loss of the transformer/rectifier unit, or of the utility's incoming medium-voltage power; but that the dc feeder circuit breakers remain closed, or section bypass switches are closed, thus providing for electrical continuity of the OCS near the substation that is not powering the OCS with transformed and rectified utility power.

4.8.4 Criteria for Light Rail Vehicle (LRV) Storage Facilities

LRV storage facilities, or Yards, shall have their own TES which under normal conditions is isolated from the TES of the main line, on both the positive and negative side. Provisions shall be made, however, for the main line to serve as a backup source and supply the Yard's TES in contingencies involving the Yard TPSS being out of service.

The Yard's TES shall be designed to support car voltages above 420 V dc with the storage facility fully occupied by vehicles, each drawing maximum auxiliary power, at the same time as a four-car train is under full acceleration at location in the Yard resulting in a worst-case voltage drop.

4.8.5 Load Flow Analysis of the Traction Electrification System (TES)

The TES performance, such as train voltages, RMS and peak momentary currents in the TP substations, RMS currents in the TPSS connection feeders, power demand imposed on the utility's supply system, etc. shall be determined via load flow simulations using a

computer program that accounts for the following subsystems and aspects of the LRT operations, as parts of one integrated model:

- LRV with its weight, dimensional, tractive and breaking characteristics;
- Vertical profile;
- Horizontal alignment, including stations, curves and speed limits;
- Line(s) and track configuration;
- Traction power substations;
- Positive dc distribution system;
- Negative dc distribution system;
- Utility medium voltage ac system parameters at the TPSS interface points;
- Train resistance to motion, as impacted by track curves and grades;
- Train operations plan, including service line routing, train consist sizes, headways, and train passenger loading.

The load flow analysis for each TES configuration shall comprise multiple simulations with different DTOs. In order to capture practically all possible train status/location combinations of trains on the opposing tracks that may occur for a given headway pattern, the number of simple simulations with different DTOs shall be determined as the ratio of the headway to the DTO increment, where the DTO increment does not exceed the duration of the peak current of the vehicle during acceleration. In addition, the duration of the individual (simple) simulations shall at least match the headway cycle.

The set of such simulations is referred to as statistical run, and with the proper settings (number of simple runs and DTO increment as described above) the statistical run will cover all possible simultaneous train accelerations from the same and adjacent passenger stations, as well as other high-power coincidences in a given area, like those involving also trains re-accelerating after exiting zones with speed restrictions, or moving on steep uphill grades.

For simulation of contingency operations, the probability of the minimum train voltage falling below 420 V dc, as a function of the DTO, shall be calculated as well. The probability calculation shall be based on the ratio of the number of simple simulations of the statistical run for which the minimum voltage is below 420 V dc, to the total number of simulations comprising the statistical run.

4.8.6 Stray Current Mitigation

In order to minimize stray currents from/to the tracks for purposes of mitigating electrolytic corrosion in metal structures in the vicinity of the LRT line, as well as for safety, the traction power system design shall limit peak voltages-to-ground in the running rails to no more than 50 volts in normal system operations, and to 75 volts in contingency operations with a TPSS out-of-service.

Additional measures for stray current corrosion mitigation shall include:

- Not grounding the substation rectifier cathode or negative return bus, except at the shop rectifier, where it is grounded;
- Isolating the running rails from concrete station platforms by placing insulating material around and under the rails and filling the void with low conductive (high el. resistance) material;
- Insulating the running rails from the ties in case of ballasted track, and from the track bed in case of direct fixation track, using insulating type fittings and accessories.

The designer shall require the contractor to conduct a corrosion study before and after the start of revenue operation in accordance with the provisions of Section 3.2.5 – “Corrosion”.

4.8.7 Traction Power System Supervisory Control and Data Acquisition

New traction power substations shall be networked to central control via the LAN to the nearest station LAN and WAN network switches and interface with the AIMS Software platform provided by Arinc as described in the Communications section of this Design Criteria, Chapter 6. The system shall remotely monitor substation status and control AC/DC main breaker and all DC feeder breakers via an approved industrial PLC. Monitoring status shall include all fault annunciation points, AC breaker, DC main breaker and all DC feeder breaker positions, line voltage, and other points as directed by the SANDAG’s System Engineer. The LAN and WAN network connections shall also be used for transfer trip functionality as described in other sections of this Design Criteria.

All substations shall include substation Supervisory Control and Data Acquisition (SCADA) features. The SCADA system shall enable the following features to be viewed and controlled at the OCC:

- A line and utility service voltage and current levels;
- AC & DC breaker status and control;
- Transfer trip;
- Transformers winding temperature; and
- Rectifier temperature and diode failure (first and second stage).

SCADA and transfer trip communications shall be achieved by the use of all dielectric fiber optic cable links from each substation to the Local Area Networks (LAN) at each station. All stations and the Operation Control Center shall be linked via the Wide Area Network (WAN).

Commands shall use Modbus Protocols and bit addresses shall be consistent with those used on the existing system. The designer shall obtain a list of SCADA features, set up a meeting to review the list and review the list to determine if the list is complete or if additional features are desired in order to fulfill MTS (SDTI)’s needs. The designer shall develop additional bid addresses, if needed.

4.8.8 Transfer Trip System

DC feeder circuit breakers of different substations supplying the same electrical OCS section shall be equipped with a transfer trip system that communicates via the MTS non-vital wide area network (see the Chapter 6 – “Communications” for additional information on the non-vital wide area fiber optic network).

Short-circuit type fault detection by one of the circuit breakers shall automatically result in tripping the remaining circuit breakers feeding the same section in auto-reclose mode, with auto-reclosing preceded by load measuring.

The Traction Power Substation contract documents shall identify all standard MTS SCADA interface information including transfer trip.

4.9 Traction Power Substations

This section is intended to ensure proper placement, site preparation, and interconnection of a substation to the utility and traction power system. The designer shall coordinate design efforts with the SANDAG Systems Engineer regarding substations.

Each traction power substation (TPSS) shall be self-contained in a pre-engineered metal building, and capable of working in parallel with other substations anywhere on the San Diego Trolley system. For new lines and upgrades to the existing lines SANDAG has standardized the following aspects of the substations:

- 1.5 or 2.0 MW rated TPSS, with a duty cycle conforming to IEEE 1653.2 extra heavy traction service;
- DC switchgear with a main dc breaker and one dc feeder breaker per track per direction, with OCS sectionalizing gap at the substation;
- Low resistance grounding of dc switchgear and rectifier frames;
- 660 V dc nominal voltage (at full load and nominal voltage on the primary side);
- 4.5 percent initial voltage regulation of the transformer-rectifier unit (TRU) up to at least 400 percent loading.

Substations shall be pre-fabricated and prewired, ready for connection to: utility service points, traction power feeder cables, negative return cables, negative drainage cables and the system-wide SCADA network. Substations shall be self-contained within a weatherproof enclosure as shown in the SANDAG Standard Plans.

4.9.1 Substation Site Selection

The number, locations and power ratings of the traction power substations shall be determined from a load flow study using the ultimate train operations plan (peak period). The TP substations' number, locations and ratings shall be selected in such manner that the LRT system can maintain normal train service and meet the minimum voltage criteria with any one TPSS being out-of-service for a duration of 2 to 3 hours during the peak period of operations without overload on any of the TES equipment.

The layout of the traction power system shall result in having a substation at or near the end of each traction power section. This shall result in the installation of a TPSS with feeder connections at the end of the line extension. At locations where it is determined to be impractical for site and economic reasons, approval by the SANDAG Director or Rail is required to eliminate placing a substation at the terminus of a line.

The designer shall coordinate substation site selection with SANDAG to avoid basing a design on an unacceptable site. Considerations shall include: catenary system voltage, environmental land use, visual impact, cost for SDG&E service and availability of right-of-way.

Substation spacing shall be determined by the designer based on the load flow analysis and the operational performance criteria establish for the load flow study. Spacing shall provide for adequate line voltage under worst case conditions with a single traction power substation off line.

Traction power substations shall be located as close as possible to the tracks, ideally within 250 feet of the nearby track.

4.9.2 Substation Site Requirements

Substation site shall be designated to accommodate two substations unless otherwise directed by the systems engineer and have a minimum 16 feet wide access road in accordance with SDG&E access requirements. A typical substation site plan is shown in Figure 4-1. See SANDAG Standard Plans for more details. A minimum of 12 feet wide access shall be provided to the substation transformer and rectifier units. Access from a vehicular access point to the substation access doors shall be provided that is not less than the width of the substation doorway width.

Where possible, substations shall be oriented so that the maintainer of the system, while facing the DC breakers, is also facing the LRT tracks. The breaker to the right shall supply power to the catenary to the right and the breaker to the left shall supply power to the catenary to the left. Laminated, site-specific schematic drawings shall be furnished and permanently mounted inside each substation showing the breakers, feeder arrangement, and the OCS to the next adjacent substation. Each substation site design shall specify the installation of all ground mats, raceways, conduit, cables, concrete foundation, and pull boxes.

Figure 4-1. – Typical Traction Power Substation Layout

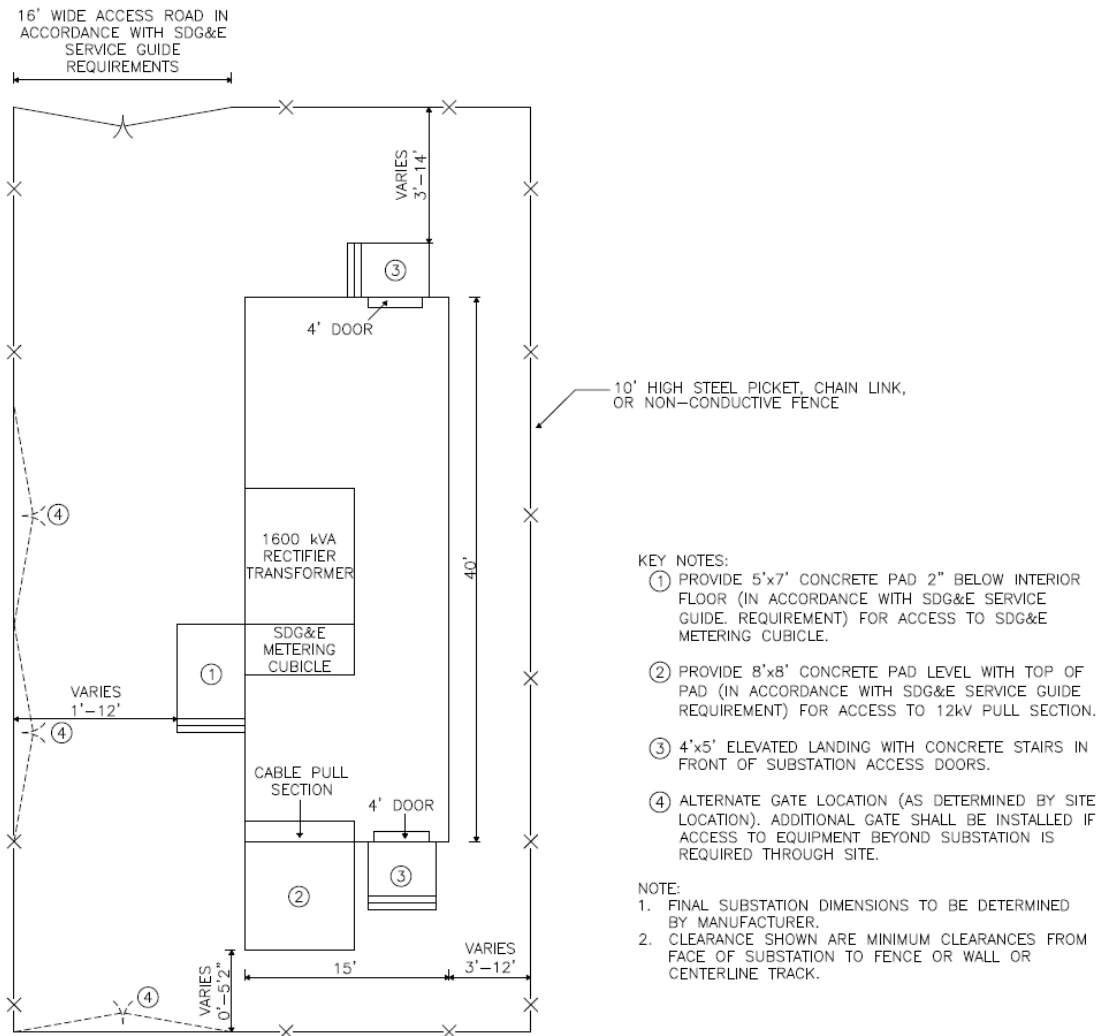

4.9.2.1 Substation Grounding Requirements

Designer shall specify a ground grid system to support the ultimate number of substations at each site as determined by the substation site requirements and utility requirements.

The substation ground mat, consisting of copper conductor and copper-clad ground rods, shall be arranged in a grid under and extending beyond the substation foundation. The ground mat shall be designed to meet the step and touch potentials criteria per IEEE Std. 80, Guide for Safety in AC Substation Grounding.

Each site shall have a soil analysis performed to establish the soil properties, including soil resistivity. The ground mat at each site shall be sized based on the worst soils conditions (e.g. moisture content during high summer temperatures with no rain for months and high soil resistivity values) so as to ensure adequate grounding is achieved at all times of the year.

Substation Ground Grid Testing procedures shall be specified that ensure that substation and perimeter fence is adequately grounded to ensure the touch potential is low enough to create a low resistance path to ground.

4.9.2.2 Concrete Slab Foundation and Fencing

The exact location of the concrete foundation shall be coordinated with SANDAG during design.

Substation sites shall be secured with a 10 feet high chain-link, steel picket, or insulated perimeter fence typically located 14 feet from the substation enclosure and beyond the limits of the ground mat. Where the perimeter fence is able to be located completely beyond the limits of the ground mat, the perimeter fence may be grounded separately.

Where site specific constraints prevent the 10 feet high chain-link, steel picket, or insulated substation perimeter fence from being located beyond the ground grid, then perimeter fence shall be grounded to the ground mat to ensure it is at the same touch potential as the ground mat.

The substation perimeter fence shall not be located closer than 9.5 feet to the nearest joint use freight and LRT track, or 7.5 feet to the nearest LRT rail only track. All of the area within the fenced perimeter shall be covered with 6 inches of 1 inch x No. 4 crushed rock as shown in the Standard Plans.

Steel picket fences are typically used at locations that are more visible to the community and the steel picket perimeter fence will help to mitigate the visual impact.

At locations where a right of way fence needs to be attached to a substation perimeter fence that is grounded to the ground mat, the insulated fencing panels should be installed to electrically isolate the right of way fence from the perimeter fence.

4.9.2.3 Utility Power Supply

A 12 kV ac, 3-phase utility service will be provided by San Diego Gas and Electric (SDG&E) for each TP substation. SDG&E will furnish, install, terminate, and connect a three-conductor, 12 kV, 60 Hz, three-phase feeder to each substation for traction power.

Designer shall design:

- A raised concrete landing with a minimum dimension of 60 inches wide by 56 inches deep with 1 foot tread width stairs in front of the SDG&E 12 kV ac utility metering access door, 2 inches below the threshold;
- A level pad at the same elevation as the top of TPSS foundation outside the pull section conforming to the requirements of the SDG&E “Electrical Standards & Guide Manual”;
- Provide a 2-inch conduit into the metering section conforming to the requirements of the SDG&E “Electrical Standards & Guide Manual”;
- The metering section in conformance with the requirements of the SDG&E “Electrical Standards & Guide Manual”;

- A 16 feet wide access road from a publicly accessible roadway to the substation with minimum curve radius of 40 feet to inside of curve (56 feet to outside of curve) in conformance with SDG&E “Electrical Standards & Guide Manual”;
- Any other SDG&E requirements contained in the SDG&E “Electrical Standards & Guide Manual” required to establish 12 kV utility service for each traction power substation site.

The designer shall work with the SANDAG Utility coordinator and SDG&E with respect to utility interface requirements, including metering and incoming circuit isolation provisions.

The designer shall incorporate the SDG&E’s service construction order showing the new primary service conduit plan and ancillary facilities for each substation that will be installed by SANDAG’s contractor in accordance with SDG&E’s service guide.

The 12 kV utility feeders to adjacent traction power substations shall be independent, and ideally supplied from different high-voltage substations, or at least different 12 kV buses of the same SDG&E high-voltage substation.

To ensure reliable service, adjacent substations shall be served by different utility distribution circuits except as otherwise directed by the SANDAG project manager. Coordination with utility interface shall be in accordance with Volume 1 – Civil Work, “Utilities” Section.

4.9.2.4 Substation Site Conduits

All conduit shall be nonmetallic, Schedule 40 PVC. Spare conduits shall extend 3 feet beyond the concrete foundation and shall be capped. Conduits for positive feeder cable and negative return cable shall not be terminated in the same substructure. The following conduits, at a minimum, are required for each TPSS:

- Eight (4-inch) For positive feeder return cables (two per DC Breaker Compartment);
- Two (4-inch) For negative feeder return cables (DC negative compartment to track);
- One (4-inch) For utility 12kV;
- One (4-inch) For utility spare;
- Four (2-inch) For spare future negative drainage cables;
- One (2-inch) For LAN communication cabling from the nearest signal case or signal feeder pole to the annunciator panel;
- One (2-inch) For remote metering to telecommunications point of connection.

The designer shall include additional positive and negative feeder conduits between the pull box located closest to the feeder poles and the pull box near the substation to provide for future cabling needs. Once a preliminary site plan has been put together for the sites, the designer shall distribute the site plans and arrange a review meeting. At the review meeting, the designer shall provide a recommendation regarding additional

spare ducts and MTS and SANDAG will determine if additional conduits should be added.

4.9.2.5 Visibility Requirement

Substations shall be equipped with an external blue light, mounted above the roof near the AC switchgear, which will illuminate in response to an annunciator alarm. If necessary, the designer shall require relocation of the blue light in order for the light to be visible to a trolley operator.

4.9.3 Yard and Shop Substations

Yard and shop facilities shall be energized by substation(s) dedicated to these loads except as otherwise directed by the SANDAG Director of Rail. The cathode of the substation supplying the shop shall be solidly grounded and isolated from utility grounds. The positive and negative circuits between the shop and Yard systems shall be isolated at the entry/exit points from the shop building. Non-bridging section insulators shall be used for this purpose on the positive side.

The positive and negative circuits between the Yard and mainline traction power system shall be isolated on the Yard side near the interface (on the lead tracks) via non-bridging section insulators in the OCS and insulated joints in the running rails. Normally open disconnect switches shall be provided across those section insulators and insulated joints, mutually interlocked, for backup power supply of the Yard from the mainline in the event the Yard TPSS is out-of-service.

If a Yard is being added to the system or an existing Yard is being expanded, the designer shall determine if an additional substation(s) is required. If so, the designer shall develop contracts for site facilities as well as preparing the procurement contract for the substation.

4.9.4 Setting the Substation On-Site

For SANDAG-furnished substations, the designer shall specify that the substation manufacturer is responsible for setting the substation on-site upon delivery. Designer shall also require the substation manufacturer to perform factory inspection and testing of substation prior to delivery and placement. The substation site Contractor shall be responsible for: a) confirming in writing with the substation manufacturer the precise conduit stub up locations and anchor bolt locations a minimum of two weeks prior to casting the pad; b) prior to substation delivery marking the precise location the substation corners on the pad; and c) confirming substation is properly set while the crane is on site and connected to the substation load.

4.9.5 Terminations of Exterior Equipment

The designer shall specify that the contractor is responsible for terminating all exterior equipment to the TPSS including, but not limited to, feeder cables, comm. cables, fans and blue lights.

4.9.6 House Power

Each traction power substation shall have an internal step-down transformer (station service transformer) supplying 240/120 volt, single-phase house power.

4.9.7 SCADA

See Section 4.8.7 “Substation Supervisory Control and Data Acquisition” for system functional criteria.

4.9.8 Traction Power Substations

The traction power substations for the San Diego LRT system shall consist of the following in terms of major equipment: ac switchgear, rectifier transformer, silicon-diode rectifier and dc switchgear. Each TPSS shall have a single transformer-rectifier unit (TRU), and shall be supplied by a single medium voltage feeder usually at 12 kV, 3-ph nominal voltage from the local electric utility company. The substation equipment shall be housed in a pre-fabricated, walk-in, weatherproof metal enclosure.

4.9.8.1 Mode of Operation and Design

Mainline traction power substation shall normally be operated with an ungrounded negative system. There shall be no direct electrical connections between the negative system and the substation ground system, or any other grounded structures except through a negative grounding device (NGD) installed between the TPSS negative bus and ground grid. The NGD shall close temporarily, thus grounding the TPSS negative bus and running rails for safety, if elevated rail potentials are detected. Stray current analysis shall be performed by the consultant using basic parameters of the track configuration, track resistance to ground, substation spacing and locations, and train operations plan in the stray current analysis.

4.9.8.2 Stray Current Drainage Facilities

A stray current drainage bus (copper) shall be installed within each substation in an area adjacent to the negative bus. The drainage bus shall be electrically insulated from the building structural steel and other grounded facilities within the substation.

Four 1 inch PVC conduits shall be installed from within the substation enclosure, adjacent to the stray current drainage bus, to a pullbox located underground, adjacent to the substation. These conduits will permit utility companies, at their option, to install drainage cables to drain stray current from underground utilities to the negative bus. Provisions shall be made to permit periodic monitoring of stray currents on utility drainage cables.

4.9.8.3 DC Surge Arresters

Leakage current of these surge arresters under normal system operations shall be as low as practical. If commercially available, gap type dc surge arrestors shall be considered in order to minimize stray current corrosion, especially due to stray currents from failed metal oxide varistor (MOV) type arrestors.

4.9.9 Negative Grounding System Protection

Protective device, known as negative grounding device (NGD) shall be installed at each traction power substation between the negative bus and the ground grid. The NGD shall automatically ground the negative bus of the substation rectifier unit and thus the adjacent running rails during the occurrence of excessive dc potentials difference between earth and the negative bus. The NGD shall also automatically remove the ground connection upon cessation, or near cessation, of the current flow between the negative bus and ground grid, in

order to minimize the stray currents and associated electrolytic corrosion threat to metal structures.

4.10 DC Distribution System

This section provides general requirements for design of the DC distribution system consisting of above and below ground conductors.

The DC distribution system shall be designed as a continuous bus allowing for load sharing amongst adjacent substations, which also results in better train voltage support.

A sectionalizing gap in the overhead contact system (OCS) shall be provided at each TPSS. Except where otherwise approved in writing by the SANDAG Systems Engineer on a site by site basis, catenary tension sections shall be terminated at near the substation using an insulated overlap which shall be used as a TPSS sectionalizing gap. Where site constraints prohibit the use of an insulated overlap to create TPSS sectionalizing and approval is granted by the SANDAG Systems Engineer on a site specific basis, then the sectionalizing gap shall be achieved by other means, like the use of section insulators. A normally-open disconnect switch shall be installed across the sectionalizing gap on each mainline track at every substation, to provide means of electrical continuity of the OCS in the event the substation's dc bus has to be de-energized.

In case of an OCS of the catenary type, each track's contact and messenger wires shall operate in electrical parallel, interconnected at frequent intervals (at every other pole typically) by in-span jumpers.

For new lines the overhead contact systems of the two tracks shall be electrically separate, except for the interconnections via the substations' positive buses.

Connection of TPSS positive feeders to the OCS shall be via pole-mounted disconnect switches to provide isolation capability for the feeder cables and substations circuit breakers from the line. The OCS feeder poles shall be equipped also with surge arrestors, preferably of the air gap type, for protection of the dc power cables and TPSS equipment from voltage transients.

The running rails shall be used as negative return conductors for each track, with the running rails of the two tracks cross bonded in accordance with the requirements described in Section 4.10.10.3.

At locations where two or more mainlines separate or join, additional DC breakers section breaks shall be added to ensure a fault on the Single Operating Line Segment will not affect the operation on the other line where the multiple line segment join and operate over a Multiple Operating Line Segment, see Figure 4-3.

Figure 4-2. – TPSS Single Line Diagram with 4 DC Breaker

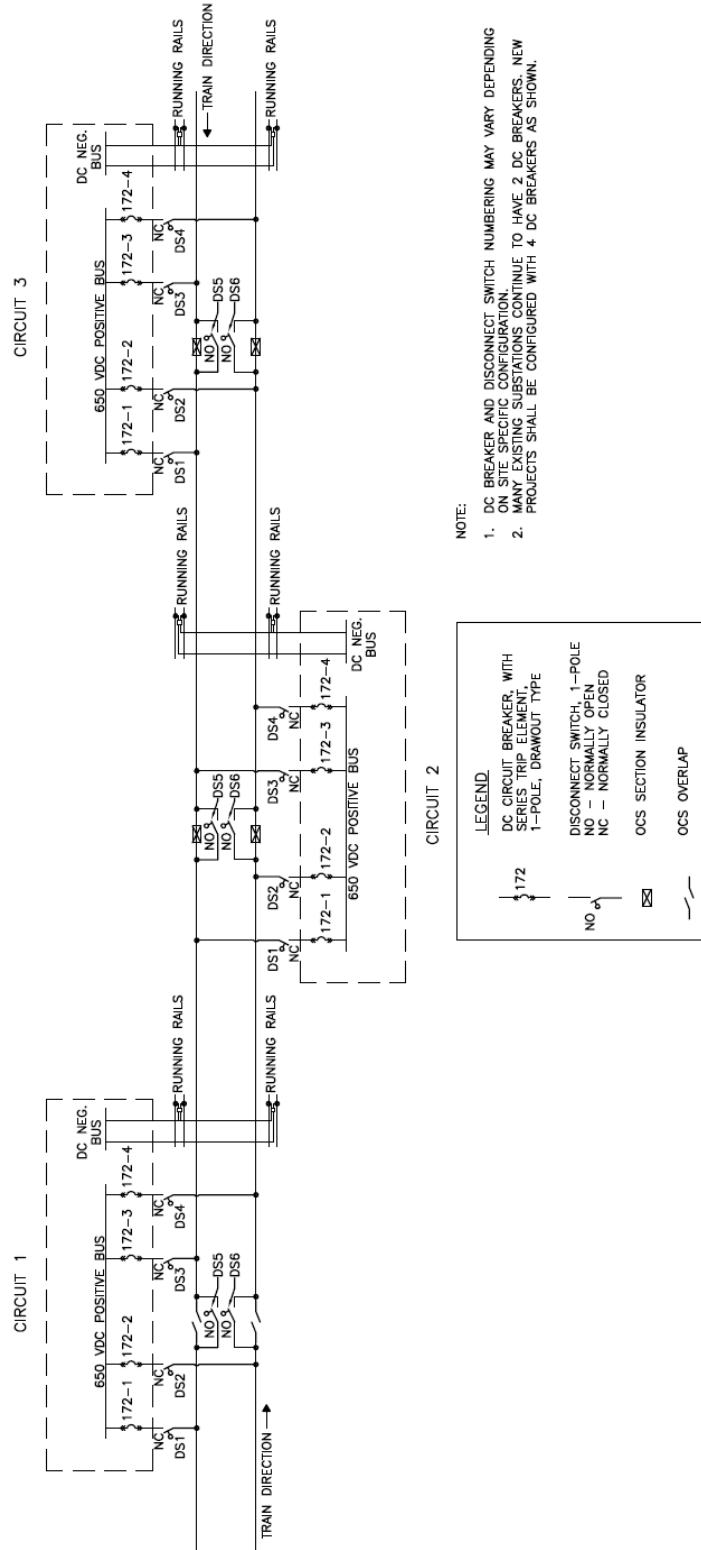
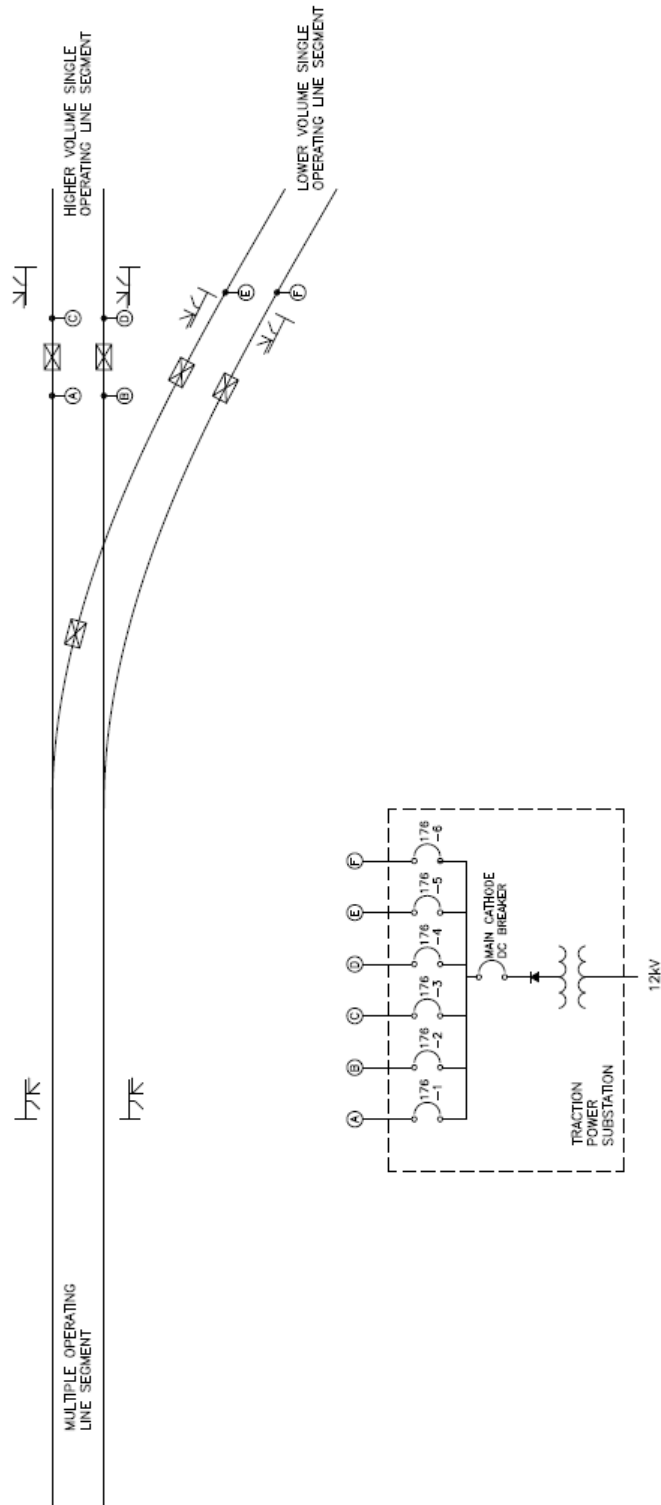

Figure 4-3. – DC Breaker Locations for Single to Multiple Operating Line Segment



4.10.1 Yard and Shop Traction Power Facilities

Yard and shop facilities shall be energized by a substation dedicated to the required load except as otherwise approved by the SANDAG Director of Rail. A non-bridging section break in the overhead contact system (OCS) shall isolate the yard substation and its load from main line substations and associated loads. At the section break location, insulated joints shall be indicated for installation in the track. Provisions shall be made for the interconnection of yard and main line OCS, and yard and main line tracks by the closing of a lockable two-pole switch, or separate interlocked single-pole switches. The overhead contact system in shop buildings shall be provided with local isolation capabilities.

4.10.2 Raceways

Positive feeder cables shall be run underground in non-reinforced red concrete encased duct banks from the traction power substation to the feeder pole located near the point of connection to the catenary suspension.

Negative return cables shall be run underground in non-reinforced red concrete encased duct banks from the traction power substation to the impedance bonds near the running rails in signalized territory or directly to the running rail pig tails in non-signalized territory.

In areas where the load flow analysis shows positive parallel feeder cables are required, the positive parallel feeder cables shall be installed in underground non-reinforced red concrete encased duct banks from a rise pole location near the point of connection to catenary suspension or substation to a rise pole location near the point of connection to the catenary suspension or substation at the opposite end of the contact wire only section.

In areas where the load flow analysis shows negative parallel feeder cables are required, such as areas with single rail track circuits in non-signalized territory, the negative parallel feeder cables shall be installed in non-reinforced red concrete encased duct banks from point of connection to the track beyond the signal track circuit limit to the point of connection to the track beyond the other end of the signal track circuit limit.

Positive feeder cables and negative return cables shall not be terminated in the same substructure, and shall not pass through the same pull box, hand hole, or manhole.

All traction power pull boxes used in new projects shall be SDG&E standard 3314, 3315, or 3316, handholes conforming to the requirements of the SDG&E "Electrical Standards & Guide Manual", except that the covers shall be hot dipped galvanized traffic rated covers conforming to the requirements of AASHTO H20 and Section 75-1.05 "Galvanizing" of the Caltrans Standard Specifications and shall be permanently labeled "DANGER - HIGH VOLTAGE - MTS" in conformance with the requirements of Section 86-2.03B "Cover Marking" of the Caltrans Standard Specifications..

Traction power feeder conduit shall be a minimum of 30 inches deep and encased in red concrete. Conduits within a duct bank shall be separated by a minimum of 6 inches on centerline. Conduit bends shall be a minimum 36 inch-radius. The designer shall establish a set of unique identification numbers for identifying the conduit runs. All underground conduits shall be Schedule 40 PVC.

The designer shall specify that the contractor is responsible for showing the conduit layouts on a conduit layer of the civil drawings in the as-built AutoCAD drawings. All conduit runs shall be shown as they are to be installed in the field. The runs shall be identified by the unique identification numbers used, depth below finished surface, offset from centerline of track for runs along alignment of track or stationing of track for lateral crossings and size and number of conduits installed. Typical cross sections shall be shown.

The designer shall specify two spare 4-inch conduits beneath LRT station platforms and paved surfaces; and two spare 4-inch conduits beneath railroad tracks at point of duct bank crossing unless otherwise specified by SANDAG. The designer shall specify that spare conduit be stubbed up into a pull box on either end of the raceway and have a tracer wire and pull rope installed in them.

4.10.3 Positive Feeder System

SANDAG has standardized the cable for the positive feeders as 500 kcmil annealed copper 37-strands conductor conforming to or exceed the requirements of: ASTM B3 and a) B8 (Class B) or b) B-496. Traction Power Cable shall be type RHH, RHW-2 constructed of ethylene propylene rubber (EPR) insulation rated for 2-kV, non-shielded, with either: a) chlorinated polyethylene (CPE) thermoset, or b) Cross-Linked Polyolefin (XLPO) thermoset jacket. Cable shall conform to the latest requirements of NEMA WC8, and UL 44, 1202, and 1581. Cable shall conform to the requirements of: a) NEMA WC-70 and ICEA S-95-658, or b) UL 1685 and ICEA T-33-655. The cable shall be suitable for installation in wet or dry environment, and its jacket shall be sunlight resistant. In addition, feeder cables to be placed in tunnels shall conform to NFPA requirements.

Substation's positive dc feeders shall be sized to accommodate the highest RMS current in contingency operations with an adjacent TPSS out of service, with trains operating at rush-hour headway at a worst-case DTO with respect to thermal load on the circuit.

Every feeder cable shall be labeled with permanent William Frick and Company 7" x 8" Snap Arounds® PVC cable tags at both ends and in every traction power pull boxes with the circuit identification number clearly identified in permanent UV resistant ink and covered with clear polyester overlay protectant sheets.

Feeder assemblies shall be specified at the feeder poles to connect the pole-mounted pressure bolted switches to the catenary messenger and contact wires and shall not be located over station platforms. The feeder assemblies shall utilize the same cable as specified above for traction power feeder cables. Feeder assembly and jumper assembly connections to the contact wire shall utilize either 350 or 500 kcmil stranded bare and tinned concentric rope lay copper conductor with 259 Class G stranding conforming to ASTM B 33 and ASTM B 173 for extra flexibility.

The catenary systems of the two tracks shall be electrically separate, except for the connections at the traction power substations via the positive dc feeders and TPSS bus.

Span wires shall have a double insulation specified between the catenary over adjacent tracks to prevent power flow through span wires.

The catenary system shall be designed also to enable one main line catenary section to be isolated from the adjacent main line catenary section at double crossovers, for maintenance during nonpeak service operations (see positive feeder section for additional information).

In double-track areas, the catenary over one track shall be able to be isolated electrically in sections extending between substations and crossovers, for maintenance purposes during nonpeak revenue service. Circuit breakers in the substations and normally-closed, non-load-break, pole-mounted pressure bolted switches shall be arranged to provide this functionality.

All positive feeders from the substations shall be connected to the OCS via pressure bolted pole-mounted switches. TPSS sectionalizing gaps, such as insulated overlaps shall have normally-open switches for each track's catenary that can bypass the sectionalizing insulation and provide electrical continuity of the OCS in the event the adjacent substation needs to be isolated. The pole-mounted pressure bolted switches shall be operated with a pole mounted hand throws located at approximately 4.5 feet above the finish surface similar to the arrangement used on the Old Town segment and shall be sized to handle the worst-case RMS current through the switch in contingency operations. Pole mounted, no-load, manually operated bypass and feeder switches shall have padlock lockable hand throw levers mounted at approximately 4.5 feet above the finish surface similar to those installed along the existing Old Town Corridor.

Pole-mounted, no-load, manually operated pressure bolted OCS sectionalizing gap bypass, or sectionalizing switches shall be sized to handle the maximum RMS current during operations at the peak headways, maximum consist sizes, worst-case timing offset, and TPSS out-of-service contingency conditions.

At all substation positive dc feeder locations, there shall be pole-mounted feeder switches, which shall enable the each dc feeder's cable to be isolated from the energized catenary. OCS feed-through, normally-open bypass switches shall permit the catenary insulated overlap, or section insulators in case of no overlap at the TPSS, to be bypassed.

The designer shall specify that the contractor shall notify SANDAG's systems engineering department of the location, date, and time of all positive feeder cable pulls a minimum of 48 hours in advance of the start of each cable pull. The designer shall also specify that the contractor shall pull a mandrel of the correct size through all feeder conduits immediately prior to pulling cable. Furthermore, the designer shall specify that the contractor shall submit manufacturer recommended pulling procedures with the feeder cable submittal and that all cables shall be well lubricated for at least the first 60 percent of each cable pull. All cables shall be installed per the manufacturer's cable pulling procedures.

Traction power feeder cables in vertical raceways over 30 feet in height shall be supported in traction power pull boxes and at top of feeder spouts to prevent over stressing of the cable insulation.

A lightning arrestor, connected between the catenary messenger and ground, shall be specified at each feeder pole assembly. The lightning arrestors shall be surge arrestors designed for dc overhead contact lines with parameters coordinated with LRT system's maximum operating voltage and the impulse withstand voltage of the protected equipment (feeder cables and substation equipment).

4.10.4 Negative Distribution System

The running rails insulation leakage resistance to ground for various types of track installation shall be as indicated under Section 4.8.6, “Stray Current Mitigation”.

The cable used for the negative return feeders from substation to impedance bonds shall be the same as the one specified for the positive feeders in the preceding section. Bonding cables connected to rails shall be copper class I rope lay cables insulated bonds strand cables conforming to ASTM B-172 with the same cable insulation and jacket used on the feeder cables.

Every negative distribution system cable shall be labeled with permanent William Frick and company 7” x 8” Snap Arouns® PVC cable tags at both ends and in every traction power pull boxes with the circuit identification number clearly identified in permanent UV resistant ink and covered with clear polyester overlay protectant sheets.

Substation negative return feeders shall be sized to accommodate the highest RMS currents in contingency operations that the TPSS may experience, in the event of an out-of-service adjacent TPSS and train schedule with a timing offset at the peak headway that results in the maximum RMS load on the subject TPSS.

Notifications and cable pulling requirements shall conform to those given in Section 4.4.3 – “Test Procedures”.

Impedance bonds shall be placed around rail insulated joints to allow traction power return to the substations by using both running rails of the track. The impedance bond equipment shall be placed outside the two tracks in double-track configuration, except where regular tamping is not anticipated because of non-removable pavement. The designer shall specify that all bonding to the rail of the cables leading from the impedance bond to the rails shall be within 12 inches of the insulated joint bars.

The cross bonds between running rails of the two tracks shall be coordinated with impedance bond design. Unless otherwise limited due to the signaling system block layout design, crossbond spacing shall not exceed approximately 2,500 feet, with average spacing typically in the 2,000-2,200 feet range.

The center point of impedance bonds where negative cables are to be installed shall be electrically isolated from impedance bond housings to ensure that the negative rail system is not accidentally grounded at this location.

500 kcmil connections to the rails shall utilize flexible bond strand cables connected to the rails utilizing Cembre USA AR60D rail web electrical connection systems or an approved equivalent method. Designer shall prepare a specification for the materials and installation methods to ensure a proper installation conforming to the manufacturers recommended installation methods. Non-corrosive grease shall be applied to the welds and bare cables immediately after welding and inspection.

4.11 Overhead Contact System

This section provides general requirements for the overhead contact system (OCS). The OCS consists of the catenary system, the physical support system, and the feeder system. The system shall be designed to enable a pantograph to collect current from the contact wire satisfactorily at speeds up to 55 mph, under climate conditions set forth herein.

4.11.1 General

The following requirements apply to all of the components of the overhead contact system:

4.11.1.1 OCS Limits

The OCS shall distribute DC power from substations to light rail transit vehicles operating on the main tracks, yard tracks, and within shop buildings. For more information regarding the traction power system near yard facilities, see Section 4.11.1 – “Yard and Shop Traction Power Facilities”.

4.11.1.2 OCS Electrical Requirements

Catenary system shall be sized to accommodate the calculated RMS currents in summertime operation with ambient air temperature of 115 degrees F (46 degrees C) per Section 4.1 – “Environmental Requirements” and sun exposure. OCS design shall be such that local conductor temperature, assuming 25 percent wear on the contact wire, shall not exceed 167 degrees F (75 degrees C) in normal system operations, and 194 degrees F (90 degrees C) in contingency operations with a TPSS out of service. The thermal capacity evaluation of the OCS shall be performed assuming directional timing offset between the trains moving in the opposite direction resulting in the maximum RMS current in the given OCS section.

4.11.1.3 Minimum Resistance-To-Earth Requirements

The positive power distribution circuit, consisting primarily of the overhead distribution and contact system, shall have a minimum effective in-service resistance to earth of 1.9 mega ohms/mile of a double catenary system (Leakage current less than 1 mA).

4.11.1.4 OCS Crossover Requirements

Crossover catenary shall use the same tensioning method as that used for the mainline catenaries.

4.11.1.5 OCS Overlap Requirements

Catenary tension sections shall be terminated using an insulated or un-insulated overlap, section insulator. The contact wire overlapping length shall not be less than 5 feet. Insulated overlaps shall not be located within 360 feet on approach to a location where light rail vehicles will commonly come to a stop once revenue service commences (e.g. railway signal, crossing, and far end of station platform).

The only type of sectionalizing insulation that shall be used with mainline auto-tensioned and fixed termination catenary is insulated overlaps except at crossovers, sidings, and yard leads. Where unique site conditions exist that make the installation of insulated overlaps impractical or cost prohibitive, the designer shall seek special site specific approval from the SANDAG Systems Engineer to utilize a SDTI approved section insulator assembly. When used, SDTI approved mainline section insulator assemblies shall not be located where large amounts of

current will be drawn by light rail vehicles(e.g. just leaving a station, exiting a curve, or on ascending slopes).

4.11.1.6 Length of Tension Sections for Auto Tension Catenary

The designer shall maximize the tension lengths. Tension lengths between a fixed termination and balance weight termination shall not exceed 3,000 feet. When determining tension lengths, the designer shall verify that balance weights have sufficient travel to avoid striking any obstruction (e.g. spreader brackets). Balance weights and OCS hardware need to be designed for free movement through full temperature range and provide mechanical clearances under worst conditions as well as ensuring pantograph security.

4.11.1.7 Separation from Aerial Utilities

The designer must maintain separation from aerial utilities in accordance with CPUC General Order No. 95 and the following criteria:

- The contact wire height must not fall below minimum requirements, including allowance for acceptable sag;
- If the pole provides mounts for risers to other services, the arrangement shall provide electrical isolation from 650-volt DC service;
- The force imposed by the catenary system on the poles of others must be sustained with adequate safety margin, including wind force on the catenary and its support structure by the common pole structure.

4.11.2 Support System

The physical support subsystem shall consist of all foundations, poles, frames, guys, insulators, cantilevers, head-spans, backbones, and other assemblies and components required to support the catenary subsystem in accordance with designed configuration and allowable loading, deflection, and clearance requirements.

The support system shall be sized in accordance with the latest most conservative recommendations and requirements of AREMA "Manual for Railway Engineering" Volume 3, Chapter 33, Part 4, Sections 4.2.7 and 4.2.8, UBC Chapter 16, AISC, ACI, and CPUC General Order No. 95 unless otherwise specified herein.

Catenary support poles and frames and associated hardware shall be made of non-corrosive material or be treated to prevent corrosion. All exposed steel and malleable iron shall be galvanized in accordance with Section 75-1.05, "Galvanizing," of the Caltrans Standard Specifications.

The support system includes brackets, downguys, cantilevers, bracket arm, headspans, cross-spans, terminations and counterweights. The specific materials selected shall be of adequate corrosion resistance to ensure that the required service life of 30 years will not be compromised because of corrosion related problems. The materials shall not require maintenance coatings or other procedures relating to corrosion control during the design life of these facilities. Exposed surfaces of steel or ferrous surfaces shall be hot dipped galvanized steel conforming to the requirements of Section 75-1.05 "Galvanizing" of the Caltrans Standard Specifications.

Minimum safety factors associated with structural loading (except for OCS steel poles, foundations, and cantilevers) shall be determined for the worse case environmental conditions as specified in Section 4.1 – “Environmental Requirements”. The minimum safety factor for fiberglass members is 3.0; all other material shall have a safety factor of 2.0.

Porcelain insulators shall be used to the greatest extent practically feasible (e.g. at cantilever assembly pole attachments, fixed termination assemblies, balance weight termination assemblies, mid-point anchor assemblies, messenger wire section insulator locations, in-span insulator assemblies, and headspan assemblies).

4.11.2.1 Pole and Down-Guy Foundations

All foundation locations shall be checked for conflicts with signals anywhere within the signals sighting distance. Foundations shall not be placed in drainage ditches or at the same location as other utilities.

4.11.2.2 Foundation Design

Catenary pole foundations shall be designed for no less than one and a half times the total moment calculated at the base of the pole. Pole foundations installed in fill slopes shall conform to the recommendations of AREMA “Manual for Railway Engineering” Volume 3, Chapter 33, Part 4, Section 4.2.8.

4.11.2.3 Elevation of Pole Foundations

The top of foundations located between tracks, and not in station platforms, shall be set at top of the tie of the adjacent track. Top of foundations not located between the tracks and not in station platforms or not in the pedestrian sidewalk shall be set 6 inches above the highest elevation of the existing slope that is in contact with the foundation. In station platforms or pedestrian sidewalk areas, the top of foundation shall be installed at least 10 inches below top of finished platform. Where pole base plates are embedded below the finish surface of the station platform, the base plates, bolts, and nuts shall be completely encased in concrete from top of foundation up to the finish platform.

4.11.2.4 Poles and Moment Resisting Frames

Catenary Poles shall be sized in accordance with the most restrictive recommended design standards of the IEEE OCS Pole Standard P1630, “Standard for Supporting Structures for Overhead Contact Systems for Transit Systems”, AREMA “Manual for Railway Engineering” Volume 3, Chapter 22, Part 4, Section 4.2.7 “Catenary Pole Criteria”, California Public Utilities Commission General Order 95 and shall conform to the following minimum requirements for sizing of poles and moment resisting frames:

- Either the wind load (over the pole or frame surface and attached cables) or the earthquake load (of the system), whichever is greater, shall be used in determining the pole or frame moment;
- The CBC wind load or earthquake load, whichever is greater, shall be added to the horizontal load imposed on the pole or frame due to the wire tensions to determine pole or frame moment;
- The maximum pole or frame bending moment shall not produce a deflection greater than 2.5 percent of the pole height, or greater than 2 inches at contact wire height under live loads. Joint-use poles shall be sized to include added loads of other user.

4.11.2.5 Pole and Frame Description

Poles shall be tapered, tubular-steel sections as shown in the Standard Plans. All poles shall extend a minimum of 18 inches above the highest cantilever or balance weight band, and a minimum of six inches above the highest cable supported by the pole. Poles may be used for the support of trackway or station lighting and signs. Standard obstruction clearances shall apply (see Section 3.1 – “Alignment and Clearance”). Poles, pole base covers and other rigid support structures shall be galvanized.

4.11.2.6 Grounding of Poles and Frames

The pole grounding system shall be designed so the ground resistance at the pole does not exceed 10 ohms. Catenary support poles and frames fabricated from conducting materials shall be grounded to earth by attaching a ground lead(s) to a supplemental ground rod(s). Where high resistance soils at specific sites do not permit a 10 ohms resistance to be achieved utilizing a single ground rod, additional ground rods shall be installed until the ground lead resistance is not more than 25 ohms. For poles with surge arresters and disconnect switches in high resistance soils, additional deep grounding methods should be incorporated into the design to limit the ground lead resistance from exceeding 10 ohms.

For locations other than at bridge structures, electrical ground facilities for adjacent OCS poles shall not be interconnected. This will avoid provisions of a low impedance path in parallel to stray earth current.

Except for poles on bridge structures, catenary pole grounding shall utilize either: a) separate ground rods and No. 4/0 AWG bare copper cable shall be provided for each OCS pole or b) 4/0 AWG bare copper cable coiled in bottom of cast in drill hole (CIDH) foundation with lead extending up through reinforcement cage to pole termination lug.

Where OCS poles are located on elevated structures other than bridges, the poles shall be grounded individually or in groups.

Where OCS poles will be located on bridge structures, the catenary pole grounding system shall either: a) connect to the structures reinforcing steel (provided this does not have adverse longer term effects on the structures integrity, or b) connect poles to No. 4/0 AWG cable that is installed along the deck to a junction box near the top of the the nearest bridge column or abutment and down the column or through the abutment to an earth ground.

Embedded anchoring systems shall be used for mounting catenary poles and anchorages to structures. OCS bridge soffit catenary supports (embedded and externally attached) under the bridge shall not be utilized, unless there is not a practical alternative and each bridge soffit support is approved on a site specific basis in writing by the SANDAG Systems Engineer. Where approved, provisions shall be made for galvanized catenary support channels, hot-dip galvanized swivel pin and eyebolt, and interconnected through No. 4/0 AWG copper grounding cable. This No. 4/0 AWG grounding cable shall be extended to the ground wells. Catenary support anchoring system components to be embedded in concrete structures shall be epoxy coated.

4.11.2.7 Location of Poles and Frames

Generally, center-pole construction is preferred and shall be specified when track centerline spacing permits. The offset of poles shall be within constraints of available right-of-way, and

in accordance with CPUC General Order Nos. 26-D, 95, 118, and 143B. Moment resisting frames shall not be used unless otherwise approved by the SANDAG project manager.

CPUC General Order 26-D specifies the following minimum horizontal clearances of obstructions from centerline of track on tracks supporting joint usage of LRV and freight:

- Tangent track: 8.5 feet
- Curved track: 9.5 feet

These distances are the clearance from the centerline of track to the face of the nearest obstruction, such as a pole or pole-mounted obstruction.

The minimum distance for LRV-only track is the dynamic envelope of the vehicle plus the emergency walkway where applicable.

Joint-use poles may be used, where approved, by both SANDAG and the other utility and/or jurisdiction.

4.11.2.8 Cantilever Supports

The auto-tension (AT) catenary system shall be supported, in general, by hinged cantilevers.

All cantilevers shall be set perpendicular to the track at 80 degrees F ambient.

4.11.2.9 Head-Spans

Head-spans may be used at locations where cantilever supports are not practical, i.e., over streets, at locations where multiple catenaries are supported, at locations with large offsets, etc. Where head-spans are used with auto-tension (AT) catenary, the messenger wire shall be on rollers permitting the along-track movement of the messenger wire. The type of cross span construction shall permit along-track movement of the contact and messenger wires in AT catenary.

4.11.2.10 Down-Guys

Guy wires shall be installed at a typical 45 degrees angle from the vertical unless physical constraints dictate otherwise. Anchor guys shall be enhanced visually by placing a bright yellow detector over the guy strand that is a minimum of 8 feet long. Down-guy assemblies shall be anchored to loop anchors cast in down-guy foundations, bridges, or retaining walls.

4.11.3 Catenary Suspension

This section describes the design requirements for selection of automatically tensioned (AT) and fixed tension (FT) catenary systems.

4.11.3.1 Selection of Catenary Suspension System

On new lines or line extension construction projects; single or dual messenger wire full profile automatically tensioned (AT) simple catenary system with a 3.3 feet or 4.3 feet standard system depth at the supports shall be used, except at: a) overlap supports, b) low vertical clearance areas (such as tunnels) and transition areas. The system depth may be reduced in transition sections and to go under obstructions. In areas where reduced system depths are required to accommodate low vertical constraints, reduced system depths and alternative

tensioning systems described below shall be recommended by the design and accepted by the SANDAG systems engineer.

- Low profile catenary systems, for AT and FT catenary, shall be specified when directed by SANDAG;
- A single contact wire suspension system without messenger wire shall be specified when directed by SANDAG. In such cases, parallel, underground feeds shall be specified to replace the load carrying messenger.

Retrofit of existing lines shall match the type of catenary and system depth of the existing system, unless a large scale project is being implemented or planned to upgrade the entire line to the most recent standard. The system depth may be reduced in transition sections and to go under obstructions.

Material selection for the overhead current carrying conductors and support system shall be based on the traction power system Load Flow Analysis, the Standard Plans, and Standard Special Provisions. The specific materials selected shall be of adequate corrosion resistance to ensure that the service life of the catenary system will not be compromised because of corrosion related issues. The material specified shall not require maintenance coatings or other procedures relating to corrosion control during the design life of these facilities.

4.11.3.2 CPUC Requirements

California Public Utilities Commission General Order Nos. 26-D, 95, and 143-B govern the catenary location with respect to other conductors.

4.11.3.3 Catenary Conductors Requirements

The Catenary Conductors shall be sized in accordance with the results of the system load flow analysis based on the operational and redundancy requirements of the line segment and as specified in this design criteria.

SANDAG has standardized the following:

- Messenger Conductor(s):
Single messenger conductor shall be 500 kcmil and dual messenger conductors shall be either 350 kcmil or 500 kcmil cables conforming to the following requirements:

350 kcmil or 500 kcmil, stranded, hard-drawn copper conforming to ASTM B8, class AA, for use in auto-tensioned catenary systems.
- Contact Conductor:
The contact wire shall be 350 kcmil solid grooved hard-drawn copper conforming to ASTM B47, with a minimum breaking strength of 11,800 lbs.
- Jumper wire:
The jumper wire shall be either 350 or 500 kcmil, single conductor, tin-coated soft copper, Class G, 259 strands, conforming to ASTM B 33 and ASTM B 173.

At TPSS feeder poles, all cables of the positive feeder shall be connected to the messenger wire(s) using standard feeder assemblies. Connections to contact wire shall use a minimum of two 350 kcmil or 500 kcmil jumper wire connections between the feeder cables and contact wire.

4.11.3.4 Pantographs

The design shall define the range, width, sway, position on vehicle in the dynamic pantograph envelope and shall be consistent with that which is shown in the latest version of the SANDAG Standard Plans. The design shall provide a 3-inch minimum distance between catenary support hardware and the dynamic pantograph envelope.

Each car in a train will have a pantograph in service. Each pantograph will exert 20 to 22 pounds (9 to 10 kilograms) of static upward force.

4.11.3.5 Clearance Envelopes and Wire Stagger

The design shall conform to the pantograph security envelope and maximum wire stagger requirements shown in the standard plans and as shown in the table below at the contact wire height identified in the table.

Table 4-1. – Clearance Envelopes and Wire Stagger Requirements

Contact Wire Height	Maximum Wire Stagger at Supports at Specified Contact Wire Height	Clearance Envelope at Specified Contact Wire Height (Minimum Distance from Super-elevated Centerline to Face of Obstruction)
14.5 feet above top of rail	12.5 inches	10.2 feet (5.1 feet)
19.5 feet above top of rail	10 inches	11 feet (5.5 feet)
22.4 feet above top of rail	9 inches	11.4 feet (5.7 feet)

The contact wire shall stagger in opposite directions at adjacent supports at maximum stagger values listed above on tangent track in order to improve pantograph wear, except as otherwise required by physical conditions. At support structures in curves, the super-elevated contact wire stagger measured from a line drawn perpendicular to the super-elevated centerline of track shall not exceed the values listed above. The mid-span offset of the contact wire shall not exceed 6 inches. The horizontal tolerance on contact stagger is ± 0.5 inches

The span lengths and wire staggers shall be designed to: a) provide adequate pantograph security so contact wire staggers at mid span do not exceed maximums described above b) to maintain good current collection, and c) ensure uniform wear of the pantograph carbon collector.

4.11.3.6 Contact Wire Heights

SANDAG has standardized the following in-running contact wire heights above top of rail at point of suspension for new construction:

- Above tracks used by freight trains : 22.4 feet
- Above tracks and crossings only used by LRVs: 19.5 feet
- In exclusive trolley right-of-way, the heights may be reduced to:
 - Over ballast track 14.5 feet
 - Over direct fixated track 14.25 feet

The out-of-running contact wire in overlaps shall be installed at 6 to 7 inches above the in-running contact wire height at out-of-running catenary support assemblies, unless otherwise approved in writing by the SANDAG Systems Engineer on a site specific basis.

The crossover contact wire shall follow the same profile as the main line contact wire.

4.11.3.7 Contact Wire Profiling

The design shall specify the heights required from top-of-rail to contact wire for all hangers and supports. The length of the hangers shall not be specified. The actual hangers shall be sized to fit. The contact wire height tolerance is ± 0.5 inches.

The catenary shall be profiled to the recommended maximum gradients listed in AREMA “Manual for Railway Engineering” Volume 3, Chapter 33, Part 4, Section 4.2.6. If physical constraints dictate that the transition rate be greater than the recommended maximum gradients listed in AREMA Section 4.2.6, the designer shall request a variance from the SANDAG Director of Rail. Under no circumstance shall the transition rate exceed the following:

15 mph	4.00 percent
25 mph	2.90 percent
35 mph	2.00 percent
45 mph	1.15 percent
55 mph	0.67 percent

Except for yard condition, the change of grade from one span to the next should not exceed one half the values shown below.

If the vertical rise of top-of-rail is too steep to permit the contact wire to rest in its supports, and thus causes supports to push downward on the wire, the catenary designer shall notify the track designer and SANDAG Systems Engineer and meet to consider changes to the track profile to ensure the wire can be transitioned using its’ self-weight.

If the contact wires are transitioning over a crossover or double crossover, both main line contact wire profiles shall transition at the same rate at the same stationing; based on the

stationing of one of the mainline tracks. The crossover contact wire shall be profiled the same as the main line contact wire.

4.11.3.8 Messenger Wire Heights

The messenger wire heights at the supports listed below shall be used for full profile catenary except as otherwise required. The messenger wire height tolerance is ± 1 inch. At locations where there are overhead obstructions that require the messenger wire heights to be reduced to fit under the obstructions, the messenger wire heights may be reduced as required. The messenger wire height reduction should be within a couple of poles on either side of the obstruction.

The following messenger wire heights at the supports, above in-running contact wire (AIRC) or above main line contact wire (AMC), shall be used for full profile catenary with 4 feet 3 inches system depth (adjacent long and short cantilevers shall be within 10 feet of each other).

- Standard System Depth: 4.3 feet AIRC
- At overlaps, simple crossovers, and double crossovers other than No. 6:
 - Long cantilever assembly messenger height: 4.3 feet AIRC
 - Short cantilever assembly messenger height: 5.3 feet AIRC
- At No. 6 double crossovers with center poles or outside poles:
 - Over one of the crossover movements:
 - Long cantilever assembly messenger height: 4.3 feet AMC
 - Short cantilever assembly messenger height: 5.3 feet AMC
 - Over the other crossover movement:
 - Long cantilever assembly messenger height: 4.8 feet AMC
 - Short cantilever assembly messenger height: 5.8 feet AMC

The following messenger wire heights at the supports, above in-running contact wire (AIRC) or above main line contact wire (AMC), shall be used for full profile catenary with 3 feet 4 inches system depth (adjacent long and short cantilevers shall be within 10 feet of each other).

- Standard System Depth: 3.3 feet AIRC
- At overlaps, simple crossovers, and double crossover other than No. 6:
 - Long cantilever assembly messenger height: 3.3 feet AIRC
 - Short cantilever assembly messenger height: 4.3 feet AIRC
- At No. 6 double crossovers with center poles or outside poles:
 - Over one of the crossover movements:

- Long cantilever assembly messenger height: 3.3 feet AMC
- Short cantilever assembly messenger height: 4.3 feet AMC

Over the other crossover movement:

- Long cantilever assembly messenger height: 3.8 feet AMC
- Short cantilever assembly messenger height: 4.8 feet AMC

If additional head-spans are used at double crossovers, the messenger wire height for the messenger wires shall be specified to maintain a minimum of 6-inch gap at the point of the crossover crossing.

If both center poles and outside poles are used to support the crossover catenary near the points of switch or to support the in-running and out-of-running catenaries at overlap areas, the messenger wire heights shall be changed so as to maintain a minimum 6-inch gap between the messenger cables at all points of crossing.

The messenger wire height at the supports shall be 1.5 feet above the main line contact wire for fixed termination and auto tensioned low profile catenary, except at points where the messenger wires cross. At locations where the messenger wires cross, they shall be separated by at least 5 inches under normal conditions.

Alternative low profile system depths may be used in areas with limited vertical clearance, if approved by the SANDAG Systems Engineer in writing.

Should the system depth along a corridor need to transition from full system depth (either 3.3 feet or 4 feet) to low profile system depth, then the designer shall show the heights of the messenger and contact wires in the transition section between system depths on the OCS plans.

4.11.3.9 Design Span Lengths

Design span lengths for tangent track shall be determined by the distance between curves and crossings. The maximum span lengths shall ensure that the contact wire does not exceed the maximum pantograph security values and wire staggers so the contact wire will remain over the pantograph under the worst case operating conditions.

When sizing the maximum span lengths the designer shall review the vertical profile of the track. In areas with vertical crest curves, the designer shall verify that the minimum length of the hanger at mid-span is not less than 8 inches. The hanger length and span length calculations shall assume that the contact wire will maintain a constant height following the profile of the track. The hanger length calculation shall account for the additional internal forces in the hangers resulting from the resultant contact wire tensions and the additional sag in the messenger wire resulting from the internal forces in the hanger assembly.

The determination of span lengths for single wire systems shall take into consideration the requirements of Rule 74.4 of CPUC General Order 95 regarding broken OCS suspensions and fastenings.

The span length of full profile and low profile catenary systems shall never exceed the following absolute maximum span lengths:

- 205 feet for full profile, AT catenary
- 180 feet for full profile, FT catenary
- 170 feet for low profile, AT catenary
- 130 feet for low profile, FT catenary

4.11.3.10 Design Tensions for Auto-Tension (AT) Catenary

Design tensions for AT catenary shall be constant for the temperature range from 15°F to 130°F.

Conductor tensions shall be in accordance with the requirements of CPUC General Order 95. Thirty percent cross-sectional area loss due to wear of the contact wire and the effect of temperature change shall be taken into consideration in the design for conductor tension.

The constant tension of the messenger wire shall be:

- 6,000 or 7,000 pounds for catenary suspensions with a single 500 kcmil catenary messenger wire;
- 3,750 pounds for catenary suspensions with dual 350 or 500 kcmil catenary messenger wires.

The constant tension of the contact wire shall be:

- 3,000 pounds for single messenger catenary suspension systems;
- 2,500 pounds for dual messenger catenary suspension systems.

4.11.3.11 Design Tensions for Fixed-Tension (FT) Catenary

Design tensions for FT catenary conductors shall be determined based on the span length, pantograph security, stagger, etc. The wire safety factor under the worst condition needs to meet the requirements of CPUC General Order 95.

Calculations of tension adjustments due to temperature variation must be approved by SANDAG.

4.11.3.12 Tensioning Methods

The following tensioning methods shall be used:

- Balance weight assemblies shall be used to tension auto tension catenary. The designer shall verify at all balance weight locations that there will be sufficient travel available for the balance weight to move throughout the temperature range of 15 degrees F to 130 degrees F (-9 degrees C to 54 degrees C) ambient. All balance weights shall have a guide system to prevent the balance weights from swaying into the dynamic envelope of the vehicles. The designer shall specify that all balance

weight settings be checked by the engineer after all adjustments have been made to the system. Balance weights shall not be located over a station platform.

- Fixed termination assemblies may be used in both auto tension and fixed tension systems.
- Spring tensioning assemblies shall not be used except for temporary installations.

4.11.3.13 Lightning Arrestor Assemblies

A lightning arrestor, connected between the catenary messenger and earth ground, shall be specified at each feeder pole. Lightning arrestors shall not be located over station platforms.

4.11.3.14 Midpoint Anchors

Midpoint anchors shall be used between the termination poles with balance weight assemblies at both ends. Retainer wire which is to hold catenary messenger and contact wire conductors in a fixed position shall be used at midpoint. The midpoint anchor assembly shall be designed to sustain the full tension loads of the catenary under broken wire condition without failure for not less than the full tension of the catenary suspension tensions delivered at the balance weight assembly.

4.11.3.15 Wire Cross Assemblies

Wire cross (bridging) assemblies shall be installed over crossovers and turnouts where the main line and in-running crossover or turnout contact wires cross.

4.11.3.16 Additional Requirements for Full and Low Profile Catenary

The following requirements shall be met for full and low profile catenary:

- The spacing between adjacent wire rope hanger assemblies shall not exceed 30 feet;
- Hanger assemblies shall be constructed of 316 stainless steel wire rope with ultraviolet resistant black nylon insulated thimbles, crimps, split contact wire clamp, and messenger wire clamp assemblies properly adjusted to provide a smooth riding surface at the specified contact wire height(s);
- In-span jumpers between the contact wire and messenger wire(s) shall be specified at spacing not exceeding 410 feet;
- Full feeding continuity jumpers at uninsulated overlaps shall match or exceed the thermal capacity of the OCS conductors.
- Standard full feed jumper assemblies shall be used unless determined by the designer to be inadequate for the intended use in which case the standard assembly shall be modified to add additional conductor and clamps as needed.
- Cable length between messenger wire clamps shall provide sufficient slack to ensure lateral movement throughout the temperature range of the catenary suspension conductors is not obstructed (the cable distance between adjacent messenger clamps connecting different wire runs shall not be less than 5 feet);
- Potential equalizing jumpers connecting the out-of-running contact to the out-of-running messenger to the in-running messenger shall be specified at insulated

overlaps to bring the out-of-running conductors to the same potential as the in-running-conductors to ensure conductors near the support at the same potential;

4.11.3.17 Additional Requirements for Tunnel Catenary

The designer may use other types of catenary in tunnel sections. Reduced profile auto or fixed tension catenary using a system depth determined by the designer or a conductor rail system are preferred. Contact wire only with a parallel feeder is not preferred, but may be used if approved by SANDAG.

4.12 Stray Current/ Reduction Methods

4.12.1 Stray Current Reduction

To the greatest extent reasonably possible, track design shall insulate the running rails to create a high resistance path to ground to minimize leakage current. Structures, maintenance and underground facilities shall be designed with stray current reduction methods. Stray current reduction methods criteria are included in the design criteria for the various types of facilities and structures.

4.13 Atmospheric Corrosion Control

4.13.1.1 General

The design of exposed equipment and facilities shall consider the possible impact of atmospheric corrosion conditions, with the primary objective being to ensure that the required 30-year service life of a particular facility is not compromised because of corrosion related problems or failures.

4.13.1.2 Traction Power Substation Enclosures

Exterior metallic surfaces of the substation enclosures shall be coated with a gray barrier type coating that is consistent with the most recent substation procurement.

5.0 RAILWAY SIGNALING AND INDICATION SYSTEMS

Railway circuits shall be properly designed for the intended operation.

When automated trolley switching and indication are required in track that is not designed for train protection per Table 1 of General Order 143B, then the design of the automated features and indications shall conform to the requirements of section 5.2 “Non Signalized Right-of-Way”.

When automated railway switching, control, and indication (signals) are required in automated railway signaling systems per Table 1 of General Order 143B, then the design of the automated features shall comply with section 5.3 “Railway Signaling in Semi-Exclusive or Exclusive Right of Way”.

Refer to the following documents for definition of the terms used herein:

- American Railway Engineering and Maintenance-of-Way Association Communications and Signal Manual of Recommended Practices;
- Code of Federal Regulations Title 49 (CFR 49) Transportation Parts 234 and 236.

5.1 General

All Railway Signal and Indication Systems shall comply with the following general requirements.

Railway Signaling System computer aided drawing files shall be provided by the designer to SANDAG Systems Configuration Manager. The Construction Contractor shall update design drawings with as-built information and submit final drawings for the installed system.

5.1.1 Environmental

All systems shall be designed to operate given the environmental conditions indicated in Section 4.1 – “Environmental Requirements”, except as otherwise listed below:

Ambient Outdoor Temperature: -32 degrees C to +71 degrees C.

Relative Humidity: from zero to 100 percent

Maximum Wind Velocity: 100 miles per hour

In addition to the requirements stated above, electronic / software-based products / equipment used in safety critical (vital) applications and systems shall conform to the requirements specified the AREMA Communications and Signaling Manual Part 17.3.1. Note the requirement for conformance to “United State Department of Defense, Military Standard ...System Safety Program Requirements, MIL-STD-882C”.

Non-vital communications equipment in railway signal enclosures shall be designed to operate given the environmental conditions indicated in Section 4.1 – “Environmental Requirements”, except as otherwise listed below:

Ambient Outdoor Temperature: -32 degrees C to +71 degrees C.

Relative Humidity: from 10 to 95 percent

5.1.2 Acceptance Testing and Measurements

The designer shall include in the Special Provisions detailed testing procedures, submittal criteria, and acceptance criteria for each of the tests specified. The designer shall also specify that the contractor shall submit a Test Plan, Testing Procedures, and Test Data forms for approval by the SANDAG construction manager a minimum of 60 working days prior to the scheduled start of the test. The designer shall also specify that the contractor shall submit the results of each of the tests within five (5) working days following each test.

The designer shall specify that:

- The test plan and procedures shall meet the recommended practices of the AREMA Communications & Signal Manual of Recommended Practices and all other requirements of governing agencies;
- The contractor shall perform pretests in advance of actual testing;
- The contractor shall notify the SANDAG construction manager of the location, date, and time that testing will be performed a minimum of five working days in advance of actual testing;
- The contractor shall include complete details of test results and corrections or adjustments performed on the signaling system during testing and all items to be corrected with the final test results report.

The designer shall specify additional acceptance measurements to be taken by the contractor for contract acceptance. The list of acceptance measurements to be taken by the contractor shall be submitted by the designer to the SANDAG project manager for approval with the 65% submittal.

5.1.2.1 Test Documents

The designer shall specify that at least six copies of each test document shall be submitted to the SANDAG construction manager and that the documents shall be approved prior to testing. The designer shall also specify that six sets of all revisions to the test document shall be submitted to the SANDAG construction manager.

5.1.2.2 Test Plan

The test plan shall include the following information:

- Title of each test with reference to the respective article or section number in the Special Provisions;
- Organization performing each test;
- Test location;
- Submittal date of each test procedure, test report, and/or certified test document;
- Starting date of each test;

- Completion date of each test.

5.1.2.3 Test Procedures

Test procedures shall conform to the following minimum requirements:

- Title of test, date, and name of individuals who prepared and approved the procedure;
- Test objectives;
- Test location and date of test;
- Equipment and instrumentation with the accuracy and calibration data;
- Test methodology, including test setup with circuit diagrams and test sequence;
- Test criteria including data evaluation procedures;
- Test data requirements, including forms and format for recording data.

5.1.2.4 Test Reports

The test report shall contain the following:

- Title, date, and location of test;
- Name of individuals who prepared and approved the report;
- Test objectives;
- Test data forms with signatures of test witnesses;
- Observations and additional data, including tables and photographs;
- Descriptions of failures and modifications;
- Abbreviations and references;
- Summary and conclusions;
- Pass/Fail Criteria.

5.1.2.5 Test Categories

The following testing categories shall be specified when applicable to the scope of work.

- **Ground Verification Test:** This test shall verify that the ground at each location is 15 ohms or less.
- **Cable Verification Test:** This test shall ensure that each exterior cable conductor is correctly installed, has correct nomenclature, and is continuous from end to end.
- **Cable Insulation Resistance Test:** This test shall ensure that each exterior cable conductor meets the minimum conductor-to-conductor and conductor-to-ground resistance.
- **Circuit Breakdown Test:** This test shall ensure in a fail-safe manner that all wiring is in accordance with the approved circuit plans.

- **Power Supply Verification Test:** This test shall verify that all power supplies operate properly in accordance with the specified requirements.
- **Track Circuit Setup and Test:** This test shall establish the proper operating parameters for all types of track circuits.
- **Shunt Sensitivity Test:** This test shall measure the shunting margin of each track circuit to ensure that specified shunting sensitivity is obtained.
- **Preliminary Operational Test:** This test shall verify that all the individual components and subsystems are properly adjusted and functional.
- **Simulated Operational Test:** This test shall simulate train movements by using manual track occupancies to test the overall functionality of the signaling and crossing warning systems.
- **Dynamic Operational Test:** This test shall test the same functions as listed in the simulated operational test except actual vehicles shall be used to conduct the test.

Test equipment calibration requirements and additional testing requirements shall be added by the designer to the Special Provisions as needed to ensure a safe and operational system.

5.1.2.6 Compatibility with the Existing Systems

All new signaling equipment shall be fully compatible with the existing systems without exception. Each interlocking shall be controlled by vital relay circuits, vital logic controllers, or as otherwise approved by the SANDAG Director of Rail. Route selection shall be made via field devices and with an interface to the train location wide area network.

5.2 Non Signalized Right-of-Way

All LRT lines operating in non-automatic block signaling right-of-way shall be designed for a maximum speed of 35 mph and conform to the requirements of CPUC General Order No. 143B. Light rail vehicles and freight trains shall travel at reduced speeds on a line-of-sight basis.

5.2.1 Trolley and Traffic Signal Interface

Non-block signaling controlled alignments in non-exclusive or semi-exclusive right of way (per alignment classifications described in section 9.04 of CPUC G.O. 143B) with active grade crossing warning devices conforming to CPUC GO 75-D shall have grade crossing control systems interface with traffic signaling systems via a traffic preemption system in conform to section 10D.05 "Traffic Control Signals" of the California MUTCD. Light rail vehicle signal indications and controls in non-exclusive or semi-exclusive right of way (per alignment classifications described in section 9.04 of CPUC G.O. 143B) with non-gated grade crossings and without block signals shall conform to section 10D.07 "Use of Traffic Control Signals for Control of Light Rail Transit Vehicles at Grade Crossing" of the California MUTCD. Automatic block signaling shall not be used in street segments. Emergency vehicles will have a higher priority than a trolley, but will not preempt an accepted trolley preemption. In all cases, the freight train shall have highest priority. Therefore, joint trackage shall have separate detection equipment.

5.2.2 Switch Controls and Indications

The designer shall review the locations of crossovers and the operating plan and recommend to SANDAG where to locate power switches.

The following types of switch stands shall be used in mixed traffic right-of-way and in the yard.

Ground throw or spring and return switches shall be used at embedded switch locations unless otherwise directed. Spring switches shall not be used in the yard unless otherwise directed. The number of the switch will be shown in white letters and numbers on a black background on the pavement between the rails facing the train on the facing point side of the switch.

The adjustable automatic switch stands shall only be used in the yard unless otherwise directed by the engineer. Adjustable automatic switch stands - 22P (variable switch stands) shall not be used in switches that are used by freight trains. When the switch is in the normal position, the switch stand target shall display reflective white to the approaching trains. When the switch point is not in the normal position, the target shall display reflective red to the approaching train. For main line switches not in ABS limits, the number of the switch along with its type will be painted in black letters and numbers on a white background on the switch stand tie adjacent to the switch at a location identified by SANDAG. The location is usually on the switch ties, immediately adjacent to the mechanism or between the running rails on paved track.

The type of switch movement to be used shall be determined as follows unless otherwise specified.

If the switch machine is in the traveled way of mixed traffic (pedestrian, automobile, etc.) or below the 100-year floodplain, or in an area that is known to flood, or in a situation which requires the machine to be embedded, or mounted between the rails due to space limitations, the designer shall specify a submersible switch machine and earth box configuration which is NEMA 6P complaint and a split point switch with a Hanning & Kahl HW 61 series or equal shall be used. The switch machine shall be equipped with a locking system that locks both the point / tongue detector rods and drive rods which shall function independently of each other. The machine shall be trailable by rail vehicles with the closed point being positively locked and the open point being held in position with spring-actuated locking. When trailed the machine shall unlock via the open point without damage to machine components. The machine motor control voltage shall be 208VAC, other voltage configuration must be approved by the SANDAG Systems Engineer in writing. The designer shall work with the special trackwork designer to ensure that the switch machine specified will be fully compatible. Embedded switch machines shall have a traffic rated cover.

If the switch machine is in open track areas, not below the 100-year floodplain and not in an area that floods, a standard Ansaldo STS Style M-23A with electronic circuit controller (ECC) or Alstom Model 5F dual-control, or equal, either of which will be 110VDC motor control shall be used, unless otherwise directed by the SANDAG project manager. The machine will be right or left hand configured from the factory as required.

A complete switch movement assembly shall be specified. Switch movement control circuits shall conform to "Cabling Requirements" and "Relay Design" requirements of Sections 5.3.2.11 and 5.3.2.12 respectively. Switch route selection shall be made by the train-to-wayside communication (TWC) and wayside push-button controls as specified the "Push button" and "TWC Requirements" specified in Sections 5.3.2.17 and 5.3.2.21 respectively, unless otherwise specified. The TWC loops shall be installed 30 ft. in advance of the switch position indicator unless physical constraints dictate otherwise or another loop is in close proximity and can be used for this purpose. Track circuits shall be used to prevent switch movements while there is a train over the switch. All switches and rail shall be bonded and insulated as required.

Switch position indicators shall indicate the position of the established switch route. Switch position indicators shall be a McCain Traffic Supply pedestrian-type signal with 12 inches (305 mm) black polycarbonate housing and doors, black cutaway visors, and polycarbonate lenses or equal. The lenses shall be white with the appropriate diagonal or vertical switch route alignment displayed. Switch position indicators configuration shall be consistent with existing indicator configurations. When the switch is in correspondence, a solid lunar indicator shall illuminate.

5.3 Railway Signaling in Semi-Exclusive or Exclusive Right-of-Way

The signaling system shall be comprised of interlockings, intermediate signals, and automated route request systems conforming to the Code of Federal Regulations (CFR), Title 49 Parts 234, 235, and 236.

5.3.1 General

All LRT lines operating on semi-exclusive or exclusive right-of-way shall be designed with signal circuits as defined below. These criteria govern the design of the signaling system, including signals, indicators, switch lock mechanisms, switch movements, circuit elements and housings, highway crossing equipment, TWC interfaces, and traffic interfaces.

5.3.1.1 Applicable Documents

All apparatus and work included in the design, manufacture, and installation of the signaling system shall conform to the latest standards listed in Volume 1 – Introduction, "Governing Regulations and Laws" Section and the following:

- American Railway and Maintenance of Way Association (AREMA) Communication and Signal Manuals of Recommended Practice and Typical Circuits Representing Current Signal Practice for Railway Signaling;
- California Public Utilities Commission, General Orders (G.O.):
 - G.O. 26-D (Clearances on Railroads and Street Railroads as to side and Overhead Structures, Parallel Tracks, and Crossings);
 - G.O. 33- B (Construction, Reconstruction, Maintenance and Operation of Interlocking Plants of Railroads);
 - G.O. 52 (Construction and Operation of Power and Communications Lines for the Prevention or Mitigation of Inductive Interference);

- G.O. 75-D (Regulations Governing Standards for Warning Devices for At-Grade Highway –Rail Crossings);
- G.O. 88-B (Rules for Altering Public Highway-Rail Crossings);
- G.O. 95 (Overhead Electrical Construction);
- G.O. 118 (Construction, Reconstruction, and Maintenance of Walkways and Control of Vegetation Adjacent to Railroad Tracks);
- G.O. 128 (Construction of Underground Electric Supply and Communication Systems);
- G.O. 164-D (Rules and Regulations Governing State Safety Oversight of Rail Fixed Guideway Systems)

United States Code of Federal Regulations Title 23, Subpart B.

Conformance with rules and regulations that are only applicable to freight train railways are not required of railways exclusively operated by Light Rail Vehicles.

United States Code of federal Regulations Title 49, Parts 233, 234, 235, and 236.

The designer shall comply with all rules and regulations when designing railway signal systems that are intended for use by both LRT and freight train operations.

5.3.1.2 Fail-safe Design

The signaling system shall incorporate the fail-safe design principle. This means that whenever an equipment failure or adverse environmental condition affects the specified operation of a system involved with safety, the system shall revert to a state known to be safe.

Failure of a circuit or equipment that results in an indication of a dangerous or restrictive condition, whether there is, in fact, actual danger, shall have met the fail-safe requirements. Conversely, a failure that results in an indication of safe or nonrestrictive condition when, in fact, a dangerous condition may exist, shall not have met the fail-safe requirements.

5.3.1.3 Failure Modes

The signaling system shall be based on principles that permit the attainment of fail-safe operation in all known or discovered modes.

- **Closed Loops:** Fail-safe circuits shall employ the closed-loop principles that protect against open circuits, shorts, or any combination thereof.
- **Vital Relays:** Relays used in vital circuits shall meet AAR vital standards.
- **Vital Circuits:** All line circuits that energize a vital relay shall be two-wire, double-break circuits and shall be energized from an ungrounded DC power supply.
- **Grounds:** Components or wires becoming grounded shall not cause an unsafe condition.
- **Spurious Oscillations:** Any amplifier, generator, device, or active or passive element breaking into spurious oscillations shall not cause an unsafe condition.

- **Filters:** Filters used in fail-safe circuits shall be designed to prevent undesired signals from appearing at the filter output at levels that could cause an unsafe condition.

5.3.1.4 Equipment Failures and Conditions

Listed below are equipment failures and conditions that could compromise the fail-safe design. Therefore, the designer shall specify equipment and hardware and design circuits that would prevent compromise of the fail-safe design.

- **Relays (Non-vital)** Open coil, fused contacts, high contact resistance, shorted coil, armature sticking, contacts sticking, and broken spring.
- **Relays (Vital as Defined by the AREMA)** Open coil, shorted coil, or high contact resistance.
- **Transformers** Open primary, open secondary, shorted turns, primary to secondary shorts, or combinations thereof.
- **Capacitors** Short, open, or leakage.
- **Resistors** Increase or decrease in resistance.
- **Transistors** Short, open, or leakage.
- **Diodes** Short, open, or reverse leakage.
- **Coils** Open or shorted turns.
- Loss or degradation of power sources.
- Appearance of abnormal signal levels, electrical noise levels, frequencies, and delays.
- Effects of electrical interference.
- Absent or abnormal input signals.
- Opens or shorts in internal circuitry at inputs and at outputs.
- Mechanical vibration or shock.
- Drift or instability of amplifiers, receivers, transmitters, oscillators, switching circuits, and power supplies.
- Deterioration of contacts, connectors, terminals, solder connections, printed circuits, circuit adjusting devices, and mechanical devices.

5.3.1.5 Drawings, and Manuals, and Training Requirements

The designer shall furnish complete plans and specifications that include, but are not limited to: single-line track plans, tabulation sheets, interlocking drawings, and an index referencing the SANDAG Standard Plans. Plans and specifications shall be furnished on both full-size sheets and electronic files. The number of plans and specifications to be provided will be determined by the SANDAG project manager.

The designer shall also require the contractor to furnish the following drawings:

- Location plan(s) with a scale approved by the SANDAG Director of Rail showing eastbound and westbound trackage on a track plan and the location, chaining, outline, and installation details of all wayside equipment, including, but not limited to: signals, flashers, gates, bells, cantilevers, impedance bonds, track circuits, switches, derails, equipment enclosures, junction boxes, push-button stands, TWC, and electric locks. Details shown shall include mounting requirements, clearances, rail connections, foundations, stations, bridge abutment faces, and all data necessary for complete physical installation.
- Track circuit drawing(s). The track circuits shall be placed on the drawing so that their physical placement on the drawing coincides with the actual location of the track circuit.
- Line circuit drawing(s) showing all line circuits terminating at the location, with circuits continuing eastward to the right.
- Signal control circuit drawing(s), including control plans for flashers and gate lamps.
- Signal lighting circuit drawing(s), including lighting of flashers and gate.
- Switch control circuit drawing(s).
- Drawing(s) of repeater and miscellaneous circuits.
- Power distribution drawing(s), including bus loops for each relay rack.
- Rack layout drawing(s) showing the physical position and material reference number of each piece of equipment on each rack.
- Terminal board layout drawing(s) for each terminal board at the location showing each terminal, terminal number, and nomenclature of each wire connected to it.
- Physical layout drawing(s) of each equipment enclosure showing door positions, racks, shelves, terminal boards, and cable entrances.
- Physical layout drawing(s) of all conduit runs on a 1"=40' scale drawing.
- Drawings shall list the number and size, offset or stationing, and depth of every conduit run, above or below finish grade.
- Wiring diagrams.

The circuits and information from two or more consecutive drawing types may be consolidated into one drawing provided the order of the drawing information remains as shown.

The designer shall specify that the contractor shall furnish SANDAG's systems engineering department via the SANDAG construction manager with twenty (20) sets of installation, operating, and maintenance manuals of all equipment and systems utilized under the contract. Designer shall also specify that the contractor shall furnish twenty (20) sets of 11-in. x 17-in. half-size drawings as well as electronic files of all layout drawings. An additional set

of as-built circuit drawings of each signal case shall be furnished in each of the signal enclosures.

Designer shall include training requirements in the contract documents for all new equipment not currently deployed on the existing San Diego Trolley Inc. (SDTI) system. Training shall be provided by a Professional Railway Signaling Instructor or a Manufacturer Certified Trainer certified on the new equipment being supplied. The training shall be performed during a series of classes to include all SANDAG systems engineers and MTS/San Diego Trolley Inc.(SDTI) Signaling System Maintenance of Way Maintainers. Designer shall meet with SANDAG and MTS/SDTI staff to determine the total number of Trainees to attend the training sessions. Training sessions shall include all training materials and equipment and shall enable trainees to gain a “hands on” understanding of the equipment’s functionality, hardware, software, and interface wiring.

5.3.1.6 Operating Requirements

The principal functional requirements for signaling and its subsystems shall be derived from SANDAG's operating requirements.

- **Normal Operation:** Signal design shall provide for all normal operations and usual contingencies in a manner generally accepted in the railroad and transit industries, and not for abnormal circumstances. The signal system shall be designed for normal direction running or reverse running as directed by the SANDAG Project Manager.
- **Highway Crossing Warning Equipment:** The signaling subsystem shall include provisions for highway crossing warning at all public crossings within semi-exclusive right-of-way (see Section 5.4, "Grade Crossing Warning Equipment").
- **Special Condition Indications:** The signaling subsystem shall include provisions for special indications such as high water indicators and gas leak Indicators (see Section 5.3.3., "Special Condition Indications").

5.3.1.7 Electrical Compatibility

The signaling system shall not be interfered with by the vehicle borne equipment, traction power system, communication system, or foreign utilities.

5.3.2 Block Signaling

This section addresses the requirements for designing block signaling systems. A block is defined as a length of track of defined limits, the use of which is governed by block signals. Signals shall govern freight and LRT trains with indications as defined in the LRT standard operating procedures. Block signaling is required by the California PUC General Order No. 143B. Block signaling shall be used in all semi-exclusive or exclusive right-of-way unless otherwise directed by SANDAG. Absolute block signaling shall be specified where both freight and LRT trains operate jointly.

Block signals shall be designed so that the arrangement of signal apparatus, controls, and equipment prevents conflicting movements through an arrangement of tracks such as junctions, crossovers, or double crossovers. The arrangement of the signals and signal appliances shall be so interconnected that their movements must succeed each other in proper sequence. An interlocking shall be designed so that it is impossible to give clear signals to trains unless the route to be used is proved to be safe.

The designer shall ensure by overlaying civil designs in AutoCAD that signals are not obstructed by poles, retaining walls, and wayside equipment within the signal stopping sight distance.

The block signaling circuits shall control the aspects of signals to indicate that a safe route is established for train movement through either:

- Absolute block protection on sections of single track;
- Permissive block protection on sections of double track used exclusively for LRVs; or
- Absolute block protection on a section of double track used for LRT and freight trains.

5.3.2.1 Interlocked Control Circuits at Turnout Crossover and Double Crossovers

The block signaling system shall automatically align and lock a route through the interlocking limits, and indicate that a safe route is established for the train movement. Unless otherwise directed by the SANDAG Systems Engineer, routes shall be stored and processed in the order in which they are received when opposing traffic clears the interlocking.

Additional Absolute Signals shall be provided to facilitate “Turnback” movements. Absolute signals shall remain normally red until a route has been requested and assigned.

5.3.2.2 Requesting and Processing Routes

Routes through interlockings shall be automatically requested via all of the following methods at all new interlocking locations, unless otherwise directed by SANDAG:

- Central Train Control (CTC),
- Bi-Direction Train & Wayside Communication (BDTWC), or

Approach track circuit block occupancy shall be used to automatically request a route through an interlocking as follows:

- **Central Train Control (CTC) Route Request:** The line dispatcher shall be able to submit route requests and cancellations to the interlocking system via the network communications system described in Section 3.6.3 “Network Communications”. The interlocking system shall provide route request, signal indication, track circuit, TWC and other status information to the CTC system via the Network Communication system. The signal designer shall provide interface information to the Network Communication system designer so that all desired signal status information will be available for use by the CTC system.
- **Bi-Direction Train & Wayside Communication (BDTWC) Route Request:** The BDTWC loop shall be located a minimum of 10 feet in advance of the track circuit, which, when occupied, establishes the route. The BDTWC equipment shall be fully compatible with the existing BDTWC equipment on the existing SDTI SD8 light rail vehicles. Should wayside equipment not currently deployed on the system be proposed, then the manufacturer shall demonstrate the equipment is fully compatible.

- **Approach Track Circuit Block Occupancy Route Request:** In the absence of a route request via CTC or BDTWC, a normal route shall be established upon occupancy of the track circuits. Since freight trains are not equipped with BDTWC the primary method for automatic routing of freight trains is the occupancy of the approach track circuit. The system will align and lock switches for the normal direction if there is no opposing traffic. Otherwise, the route request initiated by the track circuit shall be stored as described below.

The following sequence of events shall occur in establishment and occupancy of a route:

- A CTC route request is received from the Operations Control Center via the Communications Network. The request is processed by field devices that will store routes if necessary and when appropriate a request for a clear route through the blocks in advance of the train is made;
- A TWC route request is received from the approaching train via the TWC loop mentioned above. The request is processed by field devices that will store routes if necessary and when appropriate a request for a clear route through the blocks in advance of the train is made;
- If approaching train is detected by the track circuit located before the signal in advance of the home signal. If a route has not been requested, then a request for clearance through the blocks for a normal route in advance of the train is made;
- Using vital circuits, check that advance blocks are clear;
- Using vital circuits, check that no opposing traffic is in effect;
- Using vital circuits, check that all electric locks in advance blocks indicate locked, and that their respective switch points are aligned for main line moves;
- Using vital circuits, check that all highway grade-crossing equipment is functioning and that gates are down if a train is on the crossing approach, when required;
- Using vital circuits, check that all special indications are clear, when required;
- Using vital circuits, occupancy of the track between opposing signals at adjacent control points shall prevent changing the direction of traffic from which obtained at the time the track became occupied in conformance with AREMA 16.4.3 and CFR requirements;
- Using vital circuits move and lock switches;
- Using vital circuits, provide a clear signal;
- Upon occupancy of block, establish route locking using vital circuits;
- Upon clearance of the block by the train, cancel route locking using vital circuits.

Interlocking shall be designed to function in accordance with the operating plan.

At a turnback interlocking with trailing point movements, the following additional functional requirements shall be provided. Once a train has passed through the interlocking, and while occupying the following track circuit, no following train may be assigned a route at the

interlocking until the train clears the track circuit following the interlocking detector track. After completing the first movement through the interlocking and while on the following track circuit, the unlock light on the push button shall be automatically illuminated permitting the turn back train to request a route.

New extensions and complete line segment signaling system overhauls shall incorporate protected reverse running movements from interlocking to interlocking. The designer shall design the system to include track blocks and approach circuit removal features like those used on the Blue Line from Downtown to San Ysidro.

The system shall be designed to enable previously requested routes to be canceled.

The system shall process a route cancellation request from any of the following: CTC, TWC, or wayside push button. Whenever a route cancellation is requested at an interlocking the circuits shall drop out all route requests and run time before processing a revised route request.

5.3.2.3 Non-Powered Turnout, Crossover, and Double Crossover

All non-powered turnouts, crossovers, and double crossovers in block signal territory shall have electric locks and point detection systems that when improperly aligned prohibits a clear signal to be displayed at the governing signal in accordance with AREMA C&S Manual requirements.

5.3.2.4 Restrictions to Block Control Logic

The following restrictions shall apply to block control logic, where a block is defined as a length of track over which the red control limit of the respective block signal is extended:

- One train, and one train only, shall occupy a block at any one time;
- Simultaneous clearance of a block from its opposite end shall be prevented;
- Block requests shall be stored in a one-stage buffer and be processed as soon as clearance can be granted;
- Block cancellation shall establish time locking. Time locking shall be calculated in accordance with AREMA Communications and Signals Manual, Section 2, Part 2.4.20.

5.3.2.5 Clear Block

A clear block means the block is absolutely clear of trains, and that all main line switches are aligned to the route of the block and locked.

All interlocking home signals in the block signal system shall be self-clearing upon approach of a train intending to take the respective route and block. The design shall protect against overrun due to an inability to stop when a clear signal fails due to simultaneous entry into a block, unauthorized entry into a block from a spur track, crossover, or like causes. LRT shall not be assigned a route previously assigned to freight trains until sufficient time has elapsed for freight trains to clear the interlocking, typically four minutes.

5.3.2.6 Wayside Signals

Wayside signals (intermediate and interlocking) shall display aspects in accordance with the current edition of SDTI Rules and Instructions for Employees, Section 4.5.

Wayside signals shall conform to AREMA recommendations and the following unless otherwise approved by the SANDAG Systems Engineer:

- Green aspects shall be placed above other aspects in all signal light assemblies;
- Wayside signals shall utilize Light Emitting Diode (LED) lamp units not less than 8.75 inches in diameter except for signals in tunnels and dwarf signals may be 6 inches in diameter. Signals shall be visible to LRV operators from not less than 500 feet away. Designers shall verify a clear line of sight; signals shall not be located behind catenary poles;
- On a single-head signal the center of the bottom aspect shall be approximately 13 feet above top-of-rail for joint-use track, and the center of the top aspect shall be approximately 13 feet above top-of-rail for LRT exclusive track;
- On a two-head signal the center of the bottom aspect shall be approximately 10 feet above top-of-rail for Joint LRT and Freight/Passenger-use track and 7 feet from center of the bottom aspect on the lower head to the center of the lower aspect on the upper head. On LRT exclusive track the bottom aspect shall be approximately 7 feet above top-of-rail for joint-use track and 5 feet from center of the bottom aspect on the lower head to the center of the lower aspect on the upper head;
- Signal number plates shall be a black image on a white reflective background at minimum of 5 inches high conforming to part 7.1 of the AREMA Signal Manual;
- The signal system shall support a maximum LRV operating speed of 55 mph, 40 mph for freight trains;
- All signals shall be equipped with equipment permitting them to be monitored from a remote location.

5.3.2.7 Permissive Block

Permissive blocks shall permit clear block indications for LRVs operating at minimum headway for the number of LRT lines served by the track segment.

5.3.2.8 Beginning and Ending ABS

The beginning of block signaling shall be indicated by placing a sign reading, "Begin ABS," at the point of entry. The end of block signaling shall be indicated by placing a sign reading, "End ABS," at the block end location. Signals preceding the end of block sign shall provide a yellow aspect during best condition and assume the track beyond the sign is occupied.

5.3.2.9 Track Circuits

Track circuits shall be designed to detect vehicle occupancy, throughout the length of the circuit, whenever a shunt of 0.2 ohms is applied to the rails, including turnouts. Momentary loss of shunt shall not affect the block signaling system.

Track circuits shall be designed to detect broken rail, and prevent trains from entering the affected block on track used jointly by LRT and freight trains.

All track circuit connections to the rails shall utilize Cembre USA AR60D and AR69D rail web electrical connection systems or an approved equivalent method. Designer shall prepare a specification for the materials and installation methods to ensure a proper installation conforming to the manufacturers recommended installation methods. Non-corrosive grease shall be applied to the welds and bare cables immediately after welding and inspection.

All track circuit connections to embedded track shall be installed in a hand-hole large enough to permit maintenance to access all rail connection and reconnect the track leads. All hand-holes shall be H-20 traffic rated and have a bolted removable lid.

At all impedance bond locations, track circuits shall be attached to the impedance bond terminals where the 500 MCM cables that attach to the rails terminate to the impedance bond.

The designer is to indicate the location of insulated joints, power bonds, and all other appurtenances common to the signaling-and traction power Systems with separate contract bid items for each.

Track circuits shall be one of the following types unless otherwise authorized by SANDAG:

- Power frequency track circuits when used to detect trains shall derive 110-volt AC power for opposite ends of the same track circuit from the same source. Where a power cable is not required between locations at ends of a track circuit, signal cable conductors may be used to carry 110-volt AC power from the feed end of the track circuit to the relay end as a reference for the track relay. Power frequency (60 Hz) track circuits are generally used for this purpose; however, 100 Hz track circuits are used on tracks located in the vicinity of a possibility for interference from 60 Hz power utility lines.
- Audio frequency overlay track circuits may be provided for train presence detection within interlocking limits, for electric lock release, special control features, grade crossing approach, and grade crossing island circuits.
- Electronic coded track circuits designed for use on electrified railways may be used in lieu of power frequency track circuits between interlockings and intermediate signals.

5.3.2.10 Raceway Requirements

All cables shall be run in raceways or lashed to 0.375 inches, extra high-strength galvanized steel signal messenger cables. All underground cables shall be installed in Schedule 40 PVC conduit. Aboveground cables shall be installed in either galvanized rigid steel conduit, Schedule 80 conduit, cable tray, or lashed to an aerial signal messenger. Cable trays shall only be used on bridges or in tunnels. Cable tray or galvanized rigid steel conduit shall be used in tunnels. The designer shall determine the location of the signal messenger unless otherwise directed by the SANDAG project manager. The fill factor for the conduit and cable tray shall not exceed 50 percent based on the original design.

Junction boxes shall be used where aerial signal cables connect to underground or surface attached signal cables unless otherwise specified in the scope of work or by SANDAG's systems engineering department. Junction boxes shall comply with all CPUC clearance requirements.

All signal cables shall be run through subsurface conduits through station platforms.

5.3.2.11 Cabling Requirements

All stranded conductors shall be coated copper conforming to ASTM B 8, Class B. They shall be sized as required for the installation. Cabling in enclosed spaces such as tunnels or under station and buildings shall be specified by the design and in accordance with all applicable codes and regulations. All cables shall be run in conduit. SANDAG has standardized the following cable criteria:

- **Power Supply Cable:** Cable shall be No. 6 AWG or No. 2 AWG stranded copper, rated 600V, and have type RHW insulation.
- **Power Bond and Cross-Bond Cable:** Cable shall be single-conductor 500 MCM, rated 2000V, extra flexible copper Class I rope-lay cables insulated bonds strand cables conforming to ASTM B-172, and have the same insulation and jacket specified in the traction power section for traction power feeder cable.
- **Track Circuits:** Cable shall be No. 6 AWG solid copper, insulated, and jacketed twisted pair (with 3 turns per foot) from the instrument enclosure to a handhold adjacent to the track. A No. 6 AWG stranded copper, insulated, and jacketed conductor shall be spliced to the solid copper conductor in the handhold and ran to each rail. Jacket shall be polyethylene and insulation shall be ethylene-propylene (EPR) meeting the requirements of AREMA, Communication and Signals Manual, Volume 3, Part 10.3.16 and have an average minimum jacket thickness of 60 mil and average minimum insulation thickness of 90 mil.
- **Signal Cable:** The aerial cable placed on the messenger shall be insulated, jacketed, and have at least 25 percent spare conductors and no less than 19 No. 14 conductors. All other signal cables shall be sized as needed. Insulation for all signal cable shall be EPR, meeting the requirements of AREMA, Communication and Signals Manual, Volume 3, Part 10.3.16. A polyethylene jacket shall be extruded overall. The average minimum jacket thickness shall not be less than 80 mils and the average minimum insulation thickness shall not be less than 60 mils.
- **Case Wiring:** All case wiring shall be stranded, single conductor, and shall be tin coated copper conforming to ASTM B8 Class B, ASTM B3, and ASTM B33-94. Minimum conductor size for case wiring shall be AWG 16. Insulation shall be ethylene tetrafluoroethylene (ETFE) conforming to ASTM D3159 and shall be Okozel type Z manufactured by Okonite Co. or acceptable equivalent. Unless otherwise specified herein, case internal wiring shall conform to AREMA, Communications and Signals Manual, Volume 3, Part 10.3.14 and Part 10.3.24. TWC cabling shall meet the requirements of the NEC.
- **TWC Cable:** Cable shall be two pairs (four conductors) twisted shielded No.12 AWG as required, and conform to the standard conductor requirements listed in Items A and E above.

Exterior cable entering instrument shelters and junction boxes shall have sufficient length to extend to within 6 inches of the top of the instrument shelter and then run down to the applicable terminal post as which it is terminated.

Every signal cable conductor shall be properly tagged and labeled in accordance with AREMA Communications and Signaling (C&S) Manual Part 10.4.1 using Raychem Corporation, Thermofit Marker System (TMS), or acceptable equivalent, cable tags at both ends of each conductor with the circuit nomenclature (as shown on the Contract Drawings or approved shop drawing) and the “location” or “terminal” designation information clearly identified in permanently bonded and legible identification.

Every signal cable jacket shall be labeled with permanent William Frick and Company 7” x 8” SnapArounds® PVC cable tags, or acceptable equivalent, at both ends and in every pull boxes with the circuit nomenclature (as shown on the Contract Drawings or approved shop drawing) and the “location” or “terminal” designation information clearly identified in permanent UV resistant ink and covered with clear polyester overlay protectant sheets.

5.3.2.12 Relay Design

Relays shall be plug-connected unless specifically and individually specified or authorized otherwise. Relays of each type shall be uniform in design and contact assembly. Relays shall have a sufficient number of contacts for the number of circuits to be controlled. Each relay or relay-repeater combination shall have at least two spare dependent front-back contacts. All relays specified shall be capable of rated performance through an operating temperature range of -4 degrees F to +160 degrees F (-20 degrees C to +71degrees C). The designer shall specify that the contractor shall furnish the factory test data for all relays as part of the Operation and Maintenance Manual.

Vital relays shall conform to AREMA, Communications and Signals Manual, Volume 2, Section 6, except as otherwise specified. Relays shall be of the biased-neutral, plug-in type with a transparent dust cover made of a nonflammable composition. Relays shall have nominal operating voltage of 12 volts. They shall be capable of picking up and operating continuously, without damage, when energized with 7 volts to 21 volts. The nominal voltage for special function vital DC relays may vary. Each biased-neutral vital relay shall have a minimum of six front-back contacts. All front contacts shall be silver-to-metalized carbon. Arc suppression for vital relays shall be built into the relay or into its plugboard. Contact arrangements shall be identical for similar types of relays except for special function relays. The designer shall indicate that the contractor shall provide test documents verifying that vital relay contacts used in high-current applications are rated for a minimum of 150 percent of the maximum current that will be conducted through the contact. Paralleling contacts for high-current applications shall be allowed only with the prior approval of the SANDAG project manager. Each contact used in parallel shall be rated for a minimum of 100 percent of the maximum current that will be conducted through the parallel contacts. Factory test calibration records shall be provided for each vital relay furnished.

Vital switch operating relays used for control of switch-and-lock movements shall meet the same requirements as specified for vital biased-neutral relays, except that a minimum of two front-back dependent contacts shall be supplied, and contacts shall be heavy-duty, metal-to-metal construction. Each contact shall be equipped with a magnetic blowout feature

effectively interrupt high currents and minimize contact wear. All switch operating relays shall be identical. One normal and one reverse switch operating relay shall be provided for each switch-and-lock movement. Switch operating relays shall be Invensys Rail Magnetic Stick, Alstom Type B, Ansaldo STS Model PN150BM, or equal.

Vital overload relays shall meet the requirements of vital relays, except as modified herein, and shall be used to detect a switch-and-lock movement. Each overload relay shall be furnished with two coils and a sufficient number of contacts to perform the designed and shall be indicated on the Plans. The time for pick up of the overload relay shall not exceed ten seconds. Overload relays shall be Invensys Rail, Alstom Type B, Ansaldo STS Model PN 150S, or equal.

Vital time-element relays shall be of the plug-in type for nominal 12-volts DC operation. Thermal relays or pendulum relays shall not be used as vital time-element relays. Vital time-element relays shall have a minimum of two contacts that will close only at the end of the adjusted timing cycle and at least two independent check contacts which, when closed, shall check the normal or de-energized position of the relay.

Each vital time-element relay or vital timing module shall be provided with a time adjustment that can be sealed. Timing shall be adjusted between 1 second and 15 minutes, in 1-second intervals. The timing interval shall be capable of repeated operation with an error of not more than +0.5 seconds when the applied voltage is between 9 volts and 14 volts.

The output relay for the timing module shall have the same minimum contact configuration as described above.

Electronic vital time-element relays or modules shall be microprocessor controlled and employ proven fail-safe design principles. They shall be Alstom Microchron relay and Ansaldo STS Flexichron module or equal. Surge protectors, filters, etc., shall be used to protect the electronic timers.

Vital AC relays shall meet the requirements established by the AREMA Signal Manual Section Specification, unless otherwise specified herein, with the exception that these relays shall be plug-in type and therefore shall not have a screened breather and shall not be equipped with binding posts. Vital AC relays shall be two-element, 60 Hz or 100 Hz, vane-type induction relays. Vital AC relays shall be capable of operating continuously and successfully without resultant damage with a minimum voltage range of 100 volts to 135 volts, inclusive, applied to the local winding and with a minimum voltage range of 0.75 volt to 5.0 volts, inclusive, applied to the control winding. Each relay shall have a minimum of two dependent front-back contacts. Each front contact shall be of the silver-to-metalized carbon type.

If power frequency track circuits using matching transformers are supplied by the contractor, the vital AC relays supplied shall meet all of the requirements herein above, except that a voltage range of at least 8 volts to 50 volts, inclusive, shall be required for application to the control winding.

Non-vital Relays shall be of the plug-in type, as manufactured by GRS Co., Type J, or US&S Co. LP-100, or equal. Each non-vital relay shall be equipped with a minimum of six front-

back contacts. Stationary contacts shall be bifurcated silver, palladium, or an approved equal. Movable contacts shall be bifurcated silver, palladium with gold overlay, or an approved equal.

It shall be possible to readily determine whether each relay is picked up or dropped out without disassembly or other mechanical manipulation of the relays.

The nominal operating voltage shall be 24 volts. The relay shall pick up with 18 volts or more applied to their coils, and must drop out when this voltage decreases below 6 volts. These relays shall be capable of operating continuously with up to 42 volts applied to their coils. Non-vital relays shall pick up in less than 25 milliseconds when energized with 18 volts, and shall drop out when de-energized from 28 volts in less than 50 milliseconds. These times shall be measured as a front contact closure or opening from the instant the switch applying the voltage closes, and from the instant the switch removing the voltage opens. All non-vital relays shall be identical by type and class, or function.

The designer shall specify a means for mounting an approved typed or printed relay nametag for each relay. The nametag shall be easily replaceable, but shall not come off during normal service.

5.3.2.13 Electric Switch and Lock Movements for Mainline Switches

Electric switch and lock movements shall conform to the requirements of the AREMA, Communications and Signals Manual, Volume 3 Section 12, Parts 12.2.1, 12.2.5, 12.2.15, and 12.2.16, and shall meet the following requirements:

Movements shall be Ansaldo STS Style M-23A/E, or equal. Operating time shall not exceed five seconds. The switch and lock movements shall be 110V DC, high speed. Lock, detector, and front rods shall be insulated and conform to the AREMA requirements. Each switch and lock movement shall include a standard railroad type junction box suitable for terminating the interconnecting wire and cable. A complete switch movement assembly shall be specified.

Switch lock control and indication shall be provided for all main line switches in block signal territory.

Switches at the end of double-track sections shall be power-operated and interlocked.

Event monitoring equipment shall be specified at each interlocking and conform to the requirements specified in section 5.3.2.20 "Event Recorders".

If a switch machine is located in an area that is below the 100-year floodplain or in an area that is known to flood, one of the following measures shall be taken unless otherwise directed by the SANDAG project manager.

- The design shall be changed so as to move the switch above the 100-year floodplain or out of the area that is known to flood. This is the preferred option.
- Use a switch machine that is functionally equivalent to an Ansaldo STS Style M-23A/E and is fully submersible. Alternative switch machines shall be submitted for

- approval of the SANDAG systems engineering department. If approval is given, the designer shall incorporate the submersible switch machine into the design.
- The switch machine shall be protected against flooding through some other measures. The concept of the flood protecting measures shall be submitted to the SANDAG systems engineering department for approval. If approved, the designer shall incorporate the measures into the design.

Regardless of which alternative is chosen, all circuit control equipment shall be designed for installation above the 100-year floodplain and out of the areas that are known to flood.

5.3.2.14 Electric Switch Locks with Point Detectors for Main Line Switches

Electric switch locks with point detectors shall conform to the requirements of the AREMA, Communications and Signals Manual, Volume 3, Section 12, Part 12.4.5, and shall meet the following requirements:

Electric lock shall be either Alstom Model 9B, or equal. Provide pedestal bases except where physical constraints dictate the use of a dwarf base. All rods shall be insulated, adjustable, and conform to the AREMA requirements. Each switch lock shall include a standard railroad-type junction box suitable for terminating the interconnecting wire and cable.

Switch lock control and indication shall be provided for all main line switches in block signal territory that is not equipped with an electric switch and lock movement.

On main line spur and yard tracks wherever the operation does not require clearing, as for a yard entrance, a short industrial siding, a facing point entry to a switching lead or runaround, or the like, the switch lock shall release by local presence only. A derail with circuit controller shall be required if the siding is on a downgrade to the main line.

On single main line track, wherever the operation requires clearing, the switch lock shall release by local presence and clear block traffic indication after a predetermined time. Some of the areas where the operation requires clearing are, but are not limited to: along industrial siding, a trailing point exit from a switching lead, a run-around, or a junction with an operating branch line. Timer setting shall be calculated in accordance with the AREMA, Communications and Signals Manual, Volume 1, Section 2. Part 2.4.20.

If a switch lock and point detector is located in an area that is below the 100-year floodplain or in an area that is known to flood, one of the following measures shall be taken unless otherwise directed by SANDAG.

- The design shall be changed so as to move the switch above the 100-year floodplain or out of the area that is known to flood. This is the preferred option.
- Use a switch lock and point detector that is functionally equivalent to a Alstom Model 9B and is fully submersible. Alternative switch machines shall be submitted for approval of the SANDAG systems engineering department. If approval is given, the designer shall incorporate the submersible switch machine into the design.

- The switch lock and point detector shall be protected against flooding through some other measures. The concept of the flood protecting measures shall be submitted to the SANDAG systems engineering department for approval. If approved, the designer shall incorporate the measures into the design.

Regardless of which alternative is chosen, all circuit control equipment shall be installed above the 100-year floodplain and out of the areas that are known to flood.

5.3.2.15 Main Line Switch Stands and Targets

Switch stands and switch stand targets shall satisfy the following criteria:

Rigid parallel throw gearless switch stands shall be used at all main line track switch stand locations except for embedded switch locations and in the yard, unless otherwise directed by the SANDAG project manager. When the main line switch is in the normal position and locked, the switch stand target shall display reflective white to the approaching trains. When the switch point is not in the normal position, the target shall display reflective red to the approaching train. The number of the switch will be shown in white letters and numbers on the face of the electric lock mechanism or power unit.

Switch stands for switches in pavements (ground-throw or spring switches) and adjustable automatic switch stand (Raycor 22P) shall not be used on main line switches unless otherwise directed by the SANDAG project manager.

5.3.2.16 Equipment Enclosures

Wayside signal control equipment shall be housed in water resistant, filtered, ventilated instrument enclosures along the track right-of-way, as commonly used in the railroad and transit industries. Enclosures shall be designed for the equipment climate requirements. Enclosures shall have hinged doors with three-point catch and handle with hasp for padlock. Enclosures shall be of quality grade stainless steel with moveable shelves, wire chase, and backboard.

Equipment cases shall be equipped with a thermostatic-controlled exhaust fan when the case is equipped with solid-state electronic devices.

Equipment cases and housings shall be completely factory-wired with all necessary equipment unless changes are being made to existing facilities.

Terminals and both ends of all wires shall be tagged with the circuit nomenclatures and "to and from" terminal designation assigned by the plans.

Equipment housings shall be furnished with interior lighting and a ground fault duplex 120V AC power receptacle.

Equipment cases shall be sized for 125 percent of the required equipment backboard area.

Equipment Layouts shall be similar to the configuration method used on the Blue Line with an equipment grid labeling system using numbers and letters to identify equipment locations.

5.3.2.17 Push-Button Control Stands

Push-button control stands shall be specified for installation in advance of interlocking signals or switch indicators as shown in the SANDAG Standard Plans. Push buttons are to only be used as a backup to the TWC equipment. The TWC loops located in advance of the push-button control stand is for manual requests at the interlocking and should not be confused with the TWC loops for route requests at the approach to the interlocking. Push buttons shall not be used as the primary means for establishing a route. All push-button control stands shall have an exterior red unlock light that is visible to a trolley operator, after time locking has been completed, when a new route may be selected.

5.3.2.18 Programmable Logic Controllers

Industrial-type programmable logic controllers (PLCs) may be used in lieu of non-vital relay logic circuits. PLCs shall be programmed to provide functionality that is consistent with the operation plan. The PLCs shall be equipped with five spare 110 connections.

5.3.2.19 Vital Logic Controllers

Vital Logic Controllers (VLC) shall be used in lieu of vital relay networks at interlockings, intermediate signal, and grade crossing locations. Vital Logic Controllers shall be capable of interfacing with existing VLC's presently operating on the LRT system.

VLC's shall be a Siemens Sicas 7 Programmable Logic Controller or equal. The VLC shall have been approved for use to control safety critical railway signal and train control networks by the Federal Railroad Administration (FRA) in accordance with 49 CFR Part 236, Subpart H.

The system shall be designed such that a centralized vital and non-vital processor (CPU) can control multiple wayside elements by utilizing a distributed architecture of system components. It shall be possible to install system components (CPU, I/O, signal drivers) in various locations and interconnect these components via fiber cables.

- The system shall comply with the intent of all applicable AREMA "Recommended Best Practices" for the control and indication of interlocking safety functions;
- The system shall operate in temperature range of -40 degrees F and 160 degrees F and relative humidity ranging from zero percent to 95 percent non-condensing if located in signal buildings according to AREMA recommendations Class C equipment;
- The system shall meet shock and vibration according to AREMA C&S manual for Class C equipment;
- The system shall meet EMI and EMC immunity according to AREMA C&S manual for Class C equipment;
- The system shall operate without forced air ventilation;
- The processor shall be capable of being operated by a traditional battery rectifier power supply system;
- The processor shall be of a type that has been successfully operating in an electrified transit system;

- The system shall be designed such that a centralized vital and non-vital processor (CPU) can control multiple wayside elements by utilizing a distributed architecture of system components. It shall be possible to install system components (CPU, I/O, signal drivers) in various locations and interconnect these components via fiber optic cables. The use of copper cables shall be minimized;
- The system shall be designed to provide a scalable hardware and software platform to accommodate future expansions. A non-vital local control panel (LCP) shall interconnect with the VLC at each interlocking. The LCP shall be utilized to graphically display operating status, diagnostic functions, and system and hardware faults. The LCP shall provide local control functionality (call/cancel signals, request switch movements, etc). The LCP shall display a graphical track layout.

A non-vital local control panel (LCP) shall interconnect with the VLC at each interlocking. The LCP shall be utilized to graphically display operating status, diagnostic functions, and system and hardware faults. The LCP shall provide local control functionality (call/cancel signals, request switch movements, etc). The LCP shall display a graphical track layout.

Two dedicated signaling networks shall be provided for interfacing with a VLC: a vital railway signaling WAN, and a signal maintenance network connected via the 24-strand Vital WAN signaling network cable to the SDTI Wayside Maintenance Offices currently located in Building A at 12 South 13th Street, San Diego, CA 92113. Additionally, a non-vital connection via the non-vital LAN/WAN to the Operations Control Center (OCC) shall be provided at all interlocking per Chapter 6 of the Design Criteria.

The vital network shall be a closed, protected network for the transmission of vital signal information between signal locations. This shall be a two fiber single mode (2SM) fiber optic transmission system in a ring configuration. The signal supplier shall provide hardened, industrial communication switches which provide the interface between the fiber system and the signaling equipment. The interface to the signaling equipment shall be Ethernet. An additional port shall be provided in each signal room which provides for the ability to access the CPUs and programs in other locations.

The maintenance network shall provide for remote access to the LCPs and external event recorders. Hardened, industrial communication switches shall provide the interface between the fiber system and the equipment. The interface to the equipment shall be Ethernet.

The interface to the central control office shall be an Ethernet connection provided by the signal equipment. Protocol shall be Genesis.

Designer shall ensure the specifications require the Contractor to adhere to the SDTI Software Management Control Plan for Processor-Based Signal and Train Control. Contractor shall be required to submit a comprehensive software configuration control plan for approval of SANDAG's Construction Manager.

5.3.2.20 Event Recorders

Event recorders to monitor signal and LRV operation are required at each interlocking and grade crossing and shall be Micro-Aide **CWR-24E** or an acceptable equivalent. The event recorders shall be of the microprocessor type. The event monitor shall have a proven history

of a minimum of three years and shall be capable of storing up to 12,000 event changes before depletion of data. The monitor shall record the time, date, and state of all inputs upon the change of state or any input, with an accuracy of one change per second. The event recorder shall be equipped with: a) Universal Serial Bus (USB) port to enable downloading directly to a flash drive, b) a female RJ-45 10/100 Base T Ethernet port to enable local or remote access to the microprocessor via a link to the LAN network utilizing TCP/IP protocols, c) User Friendly Software for Easy Navigation, and d) preprogrammed Graphical Displays of Recorded Events.

5.3.2.21 Train-to-Wayside Communications (TWC)

The train-to-wayside communications (TWC) system shall be used for automatic and manual route selection requests, manual canceling of route selection requests, nearside grade crossing protection route requests, and for providing train-location information. Loops may be used for multiple functions.

See Section 6.4 – “Wide Area Network Communications” for additional requirements for the TWC system.

5.3.2.22 Block and Interlocking Signal Numbering Requirements

Block and interlocking signals shall have a nameplate with a reflective letter prefix and a number. SDTI designates lines east (traveling away from Mile Post 0.00 at India and C Streets in downtown San Diego) and west (traveling towards Mile Post 0.00).

The following letter prefixes shall be used:

- South Line signal identification has the prefix "S."
- East Line signal identification has the prefix "E."
- Old Town Line signal identification has the prefix "O."
- Mission Valley Line signal identification has the prefix "M."
- Each successive operating line shall be assigned an identification prefix by SDTI.

The following signal numbers shall be used:

- Automatic block signals shall be identified by mile post mileage for the line in question to the nearest hundredth mile without decimal and have at least three digits. Mile post signs shall be of reflecting materials;
- Signals governing westward trains will have odd numbers;
- Signals governing eastward trains will have even numbers;
- Crossovers are to be odd-numbered, increasing in the eastbound direction by two;
- Interlocking signals are to be even-numbered, one number higher than the crossover number.

Interlocking signals are identified by an even single- or double-digit number followed by a letter suffix.

- Opposing signals of the same route shall have the same number but suffix "L" for governing westward trains and "R" for governing eastward trains;
- If a home signal has more than one set of route aspects, each set of signals is identified by a common prefix, number, and "L" or "R" suffix, except a suffix "A," "B," or "C" will follow the suffix "L" or "R."

On new line extension projects or a project that is a complete overhaul of an existing line segment the designer shall design the system with nomenclature consistent with that used on the Blue Line from Downtown San Diego to San Ysidro. Modifications of existing signaling systems shall utilize nomenclature that is consistent with that used on the line segment, unless a complete overhaul of the line is planned. Should the designer not be sure as to the path to take, then the designer shall consult with the SANDAG Systems Engineer prior to starting work on the design.

5.3.2.23 Layout Design Requirements

Repeater signals shall not be used except where approval is granted by the SANDAG systems engineering department, Operator of the system, and the SANDAG Director of Rail. Repeater signals may be approved for locations when there are not any other locations available that will improve the stopping sight distance of the signal.

The location of signals and equipment enclosures shall be put on a layer of the civil drawings and reviewed for conflicts. This work shall be completed before the 65 percent submittal.

Wayside signal equipment shall be housed in equipment enclosures located along the trackway in readily accessible areas. Where a equipment enclosure is installed near a slope, a retaining wall and platform shall be installed as required for access. The designer shall submit calculations for voltage drop for enclosures that are not in close proximity to the power source. Calculations shall check to ensure that there is sufficient power at the remotely located enclosure to drive the equipment. All signal enclosures shall be located above the 100-year floodplain. Signal enclosures not located in paved areas shall be surrounded by a 4-foot wide level area that is 6 inches deep with ballast. The bottom of the signal enclosures shall be a minimum of 8 inches above the top of final grade.

Line circuits and power feeds shall be double-lashed to a 3/8-inch extra high strength (EHS) galvanized steel strand aerial messenger attached via standard J-hooks banded to the catenary poles, except when required otherwise by local circumstances. Splices shall not be permitted in the signal cable. Lashing wire shall be stainless steel wire, 0.045-inches diameter minimum. At approximately 1,000 feet intervals, insulators shall be provided in the strand to minimize traction power negative return current flow and both sides of all feeder poles.

When any facilities are placed below grade, a detailed conduit cable layout and facilities plan is required.

Power supply for the signal system shall be taken from a local utility service drop and be on its own dedicated meter. A standby power supply is not required. The designer shall submit calculations for the power supply circuits and size all cables as required. Voltage drop shall

be calculated for all signal enclosures that are not located in close proximity of the utility service drop. The designer shall attempt to minimize the total number of utility service entrances required. For example, at locations in which a station platform and a grade crossing are located near each other, the utility entrance cable shall feed both the grade crossing and the station meters. The voltage drop calculations and conductor sizing shall demonstrate that supply voltage levels shall be sufficient under the worst case requirements. Doubling up power distribution conductors is permissible and preferred over utilizing step up and step down transformers. The designer may use a 240 volts power source and a step-down transformer at the enclosure location if a utility service connection is not able to be established with a close proximity to the signaling enclosure and conductor sizing to overcome the voltage drop becomes excessive in the opinion of the SANDAG Systems Engineer. Typically, power distribution conductor sizing should not exceed those shown in Section 5.3.2.11 "Cabling Requirements" for "Power Supply Cable". When new electrical service meters for the signaling system are planned to be installed at the station, the signaling system designer shall work with the station electrical designer to develop a signal electrical service enclosure containing the station electrical system and signaling system meters (typically a two or three meters arrangement).

Signal spacing shall be determined by the following requirements:

- Minimum stopping distance based on an express train must be met. An express train does not stop at station platforms; it travels at 20 mph through the station platforms. The express train is a freight train in joint-use trackage right-of-way and is an LRV in LRT-only right-of-way. Freight trains are not required to reduce speed through the station;
- Should provide even-block occupancy times based on a service train. A service train stops at all stations for a minimum of 20 seconds;
- Shall satisfy headway requirement under highest demand in accordance with the operating plan. However, in areas where special event service will be operated, signals shall be spaced to accommodate closer headways as necessitated by the special event service, typically 2.5 minutes.

Signals shall be located in areas where the line-of-sight of the signal will not be blocked by an obstruction. Signals and signs shall be located along the trackway in such a way that they shall be visible to a trolley operator at least 500 feet and a freight engineer at least 1,000 feet before their location. Signals shall not be located at the end of curves unless otherwise approved by the SANDAG project manager. The signal designer shall coordinate the location of each signal with the catenary designer, drainage designer, utility coordinator, and all other designers to ensure that the minimum line-of-sight of the signals and indications is maintained. Signals governing movements in the normal current of direction shall be located so that when viewed they are to the immediate right of the track they govern. Signals governing movements against the normal current of direction shall be located so that when viewed they are to the immediate left of the track.

Special arrangements and/or types of signaling equipment may be used in areas where the SDTI tracks parallel another railroad with approval of the SANDAG Director of Rail. The signals of the two paralleling railroads shall be easily distinguishable.

Signal placement shall not allow a train stopped for a red aspect to block a grade crossing. Signals shall not be placed in roadways, within 350 feet after a roadway, within station platform limits, or within special trackwork unless approved by the SANDAG Director of Rail. Signals should be located at the end of station platforms when signals happen to be located near stations. Block boundaries shall be at least 50 feet in front of facing point switch points and at or beyond the clearance point for trailing moves.

The designer shall try to avoid locating signals in tunnels except at the far end of a station platform.

The minimum breaking distance on LRT-only tracks shall not be less than the distance determined for an LRV on an express route at normal operating speed. LRVs on an express route travel through stations at 20 mph without stopping at the station. The minimum breaking distance on joint-use track, shall not be less than largest distance determined by the minimum breaking distance formulas for both an LRV and a freight train on express routes at normal operating speeds. Joint-use track is defined as track that is used by LRVs and freight trains. Refer to Tables 5-1 and 5-2 for minimum stopping distances.

Table 5-1. – Stopping Distance for LRV

Stopping Distance, Uphill

		PERCENT GRADE									
		0		1		2		3		4	
mph	kph	feet	meters	feet	meters	feet	meters	feet	meters	feet	meters
5	8	11	3	10	3	9	3	8	2	8	2
10	16	43	13	39	12	35	11	33	10	30	9
15	24	98	30	88	27	80	24	73	22	68	21
20	32	174	53	156	48	142	43	130	40	120	37
25	40	271	83	244	74	222	68	203	62	188	57
30	48	390	119	351	107	319	97	293	89	270	82
35	56	531	162	478	146	435	133	399	122	368	112
40	64	694	212	625	191	568	173	521	159	481	147
45	72	879	268	791	241	719	219	659	201	608	185
50	80	1085	331	976	297	887	270	813	248	751	229
55	89	1312	400	1181	360	1074	327	984	300	909	277

Stopping Distance, Downhill

		PERCENT GRADE									
		0		1		2		3		4	
mph	kph	feet	meters	feet	meters	feet	meters	feet	meters	feet	meters
5	8	11	3	12	4	14	4	16	5	20	6
10	16	43	13	49	15	56	17	65	20	78	24
15	24	98	30	110	34	126	38	146	45	176	54
20	32	174	53	195	59	223	68	260	79	312	95
25	40	271	83	305	93	349	106	407	124	488	149
30	48	390	119	439	134	502	153	586	179	703	214
35	56	531	162	598	182	683	208	797	243	957	292
40	64	694	212	781	238	893	272	1041	317	1250	381
45	72	879	268	988	301	1130	344	1318	402	1581	482
50	80	1085	331	1220	372	1395	425	1627	496	1952	595
55	89	1312	400	1476	450	1687	514	1969	600	2362	720

Table is based on the minimum braking distance formula for LRVs.

Table 5-2. – Stopping Distance for Freight Train

Stopping Distance, Uphill – 80 Tons per Operative Brake (TPOB)

		PERCENT GRADE							
		0		1		2		3	
mph	kph	feet	meters	feet	meters	feet	meters	feet	meters
5	8	420	128	296	90	211	64	152	46
10	16	880	268	610	186	431	131	312	95
15	24	1380	421	955	291	681	208	504	154
20	32	1920	585	1336	407	965	294	729	222
25	40	2500	762	1752	534	1284	391	991	302
30	48	3120	951	2206	672	1640	500	1290	393
35	56	3780	1152	2698	822	2034	620	1626	496
40	64	4480	1366	3227	984	2465	751	2001	610

Stopping Distance, Downhill – 143 Tons per Operative Brake

		PERCENT GRADE							
		0		1		2		3	
mph	kph	feet	meters	feet	meters	feet	meters	feet	meters
5	8	435	133	808	246	1530	466	2924	891
10	16	943	287	1811	552	3624	1105	7405	2257
15	24	1521	464	2939	896	6031	1838	12775	3894
20	32	2172	662	4174	1272	8682	2646	18831	5740
25	40	2893	882	5508	1679	11541	3518	NOTE	NOTE
30	48	3687	1124	6936	2114	14578	4446	NOTE	NOTE
35	56	4551	1387	8455	2577	17803	5426	NOTE	NOTE
40	64	5488	1673	10063	3067	21180	6456	NOTE	NOTE

Note: Trains shall be restricted to 20 MPH or less on downhill average grades exceeding 2 percent. Table is based on the minimum braking distance for freight trains equation.

Minimum Braking Distance for LRVs

Minimum Braking Distances provided in the table are based on the 70 percent of the maximum AW3 braking rate and an additional 2.5 percent factor of safety.

Minimum Braking Distance for Freight Trains

$$D = 0.01TV_0^2 + (80V_0)^{[1-(gt/1300)]} - (0.01TV_F^2)^{[(1-(GT/1900)]}$$

Where:

D = Distance required for safe braking

T = Tons per operative brake

V₀ = Velocity at origin, mph

V_F = Final velocity, mph

G = Average grade of block

Average Grade = (DG Total) / Total Block Distance

DG Total = (Distance x Grade) + (Distance x Grade) + ...

5.3.3 Special Condition Indications

Designer shall submit as part of the 35 percent submittal a list of locations that contain potential hazards that may have an adverse effect on the normal operation of the trolley segment. Such potential hazards include, but are not limited to:

- Flooding of the travel way: A high water indicator system shall be installed at locations in which the top-of-rail is below the 100-year floodplain.
- Plausible leak containing flammable or hazardous gases: A gas indicator system shall be installed at locations at which there is a major gas distribution facility immediately adjacent to our facility and the facility loads and unloads fuels.

SANDAG shall review and approve the design for each item on the list.

The indicators shall be mounted on the mast of a high signal in the normal direction at locations that will assist operations in establishing turn back movements on the system in the event of a hazardous situation.

The hazard indication system shall detect the hazard, turn all block signals between indicators red, and turn the hazard indicators from white to red. Hazard indicators shall be a McCain Traffic Supply pedestrian-type signal with 12-inches black polycarbonate housing and doors, black cutaway visors, and polycarbonate lenses or equal. The indicator shall normally display an illuminated white letter aspect and shall be consistent with the indicators on the existing system. The illuminated letter aspect shall be a "W" for high water indicators and "G" for gas indicators. If other hazard indicators are required, the designer shall

recommend a new illuminated letter aspect and request approval from the SANDAG Director of Rail in writing.

All special indicators and equipment in areas where there are special indications shall have power back-up or be fed off of the traction power system.

5.4 Grade Crossing Warning System

All crossings on semi-exclusive right-of-way shall have highway crossing warning systems that utilize “active warning devices” at locations and in configurations determined by a diagnostic team made up of knowledgeable representative of the parties of interest in a railroad-highway crossing or a group of crossings per Title 23 of the United States Code of Federal Regulations (CFR) – Highways, Part 646 – Railroads, Subpart B. Whenever possible Federal-aid Highway funds should be used to fund the crossing improvement projects in accordance with Title 23 of the CFR, Part 646, Section 208. Some of the types of warning equipment include, but are not limited to, crossing gate(s) and cantilever(s) complete with bell(s) and flashers.

Figure 5-1. - Grade Crossing Warning System

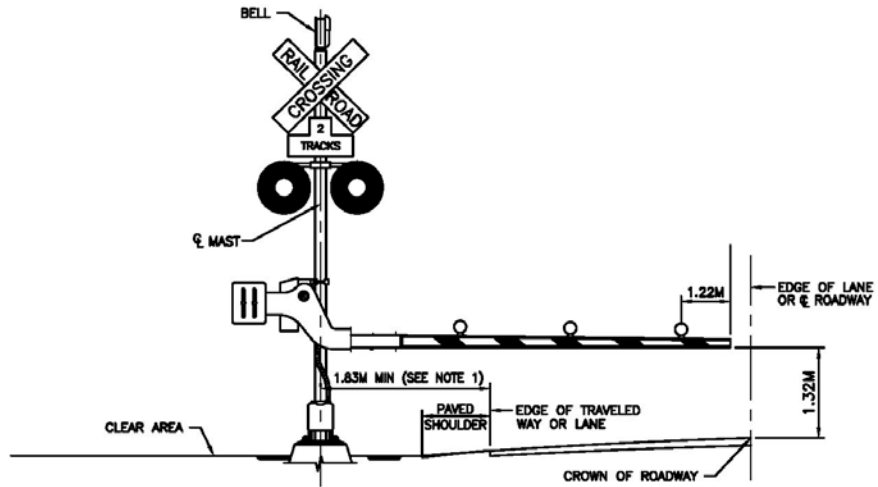

NO CURB OR GUTTER

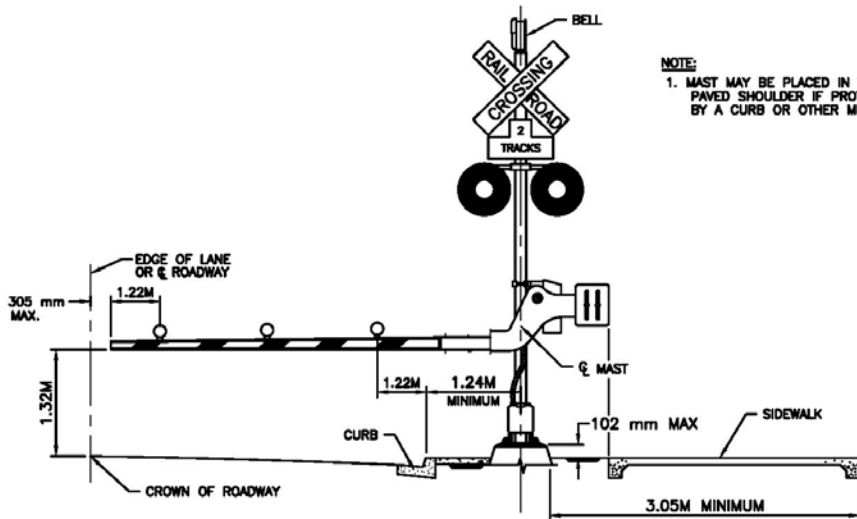

NOTE:
 1. MAST MAY BE PLACED IN THE PAVED SHOULDER IF PROTECTED BY A CURB OR OTHER MEANS.

WITH CURB

The designer working as a member of the diagnostic team shall prepare design concepts in accordance with the CFR Title 23, Part 646.214 “Design” and all California Public Utilities Commission Requirements. The diagnostic team shall review the design concepts and determine what type and configuration of warning devices SANDAG shall use at each crossing and then design the control circuits for the accepted equipment and configuration. All designs shall be consistent with the existing system. Railroad warning devices and LRT devices are to be designed and installed in accordance with Public Utilities Commission General Order No. 75-D, AREMA Communications and Signals Manual, Volume 1, Section 3; and the manual on Uniform Traffic Control Devices (MUTCD), Part 5, Chapter 5F and Part 8. Crossing signals and gate devices shall be placed to provide 19 feet of vertical clearance, for auto and truck traffic, above the base of curb or edge of traveled way when the crossing arm is prohibited from rising up to its full upright position. See Figure 5-1 for typical placement. Additional flashers shall be added at pedestrian crossings where the standard crossing layout does not warn pedestrians visually and audibly of the approaching LRV and warrant extra protection unless otherwise directed by the SANDAG project manager.

5.4.1 Circuit Design Requirements

In the event the crossing warning equipment is within 200 feet of a traffic signal controlled intersection, the crossing warning equipment, as a minimum, shall be tied into the railroad preemption in the traffic signal controller. A traffic signal interconnect circuit shall be used on all new or reconfigured crossings that are located within 200 feet of a traffic signal controlled intersection. The traffic signal interconnect circuit shall conform to AREMA Communications and Signals Manual, Volume 1, Section 3; and MUTCD Part 8 circuit design standards and requirement and shall preempt the traffic signals upon activation by an approaching train. A traffic study shall be required with specific recommendations as to design upgrade, if any, for the existing traffic scheme and shall be approved by the SANDAG Director of Rail. Unless otherwise directed by the City’s traffic engineer all new and retrofitted traffic signalized intersections that are interconnected with railroads signal controls shall be provided with battery backup power for all interconnected devices including, but not limited to, traffic signals, advance warning flashers, blank out signs, and traffic signal controllers.

"Automatic gate type" signaling shall conform to provisions within General Order No. 75D. When this type or any other type of automatic railroad crossing warning device is within 200 feet of traffic control signals or required by traffic studies, the traffic control signals shall be coordinated with the railroad signal by using a typical railroad preemption sequence. The crossing warning activation time shall comply with the AREMA Communications and Signals Manual, Volume 3, Section 3, Part 3.3.10 “Recommended Instructions for Determining Warning Time and Calculating Minimum Approach Distance for Highway-Rail Grade Crossing Warning Systems” The traffic signal designer shall work with the railroad signaling designer on the systems interface. If additional software and/or hardware modifications are required in the traffic signal controller in order to accommodate the pedestrian clearing phase, then the designer shall provide notification and design requirements to the authority with jurisdiction for the traffic signal, with the approval of the SANDAG project manager.

Nearside crossing control shall be provided at crossings where an LRT station is located between the crossing and the beginning of the crossing approach track circuit, unless

approval is not granted by the CPUC. The designer shall prepare all necessary documentation needed to obtain approval by the CPUC for nearside crossing control approval. The crossing approach track circuit shall be sized for an express train. TWC shall be used to initiate the nearside crossing control circuit. The crossing relay shall remain energized for a predetermined length of time, when the train intends to make a station stop, by incorporating the latch-out control circuit in the crossing control scheme. The nearside indicators shall be installed at the beginning of the audio approach track circuit and on the right side of the tracks when viewed from the normal direction of traffic. The TWC loop shall be located approximately 500 feet in advance of the nearside indicator except when site constraints dictate otherwise. The nearside indicator shall be a McCain Traffic Supply pedestrian-type signal with 12 inches black polycarbonate housing and doors, black cutaway visors, and polycarbonate lenses or equal. The nearside indicator shall normally display an illuminated white "E" Light Emitting Diode (LED) aspect under a dark yellow "S" LED aspect. The train operator, when on a service route, shall be able to see the indication change from the express route indication "E" to the service route indication "S". All nearside crossings shall have an event recorder as specified in Section 3.5.3.2S. The flashing indicator beacon (FIB) shall remain dark until a train activates the nearside crossing circuit or crossing approach circuit. The FIB indicator shall be illuminated solid until the latch-out control time expires and the nearside crossing warning devices are activated at which time the FIB will flash. The FIB indicator at the crossing shall be a red LED X and flash until the gate is completely down. The red X FIB indicator shall then remain lit (illuminated) until the gates begin to rise.

Gate lowering shall be delayed three to ten seconds from initiation of bells and flashers to allow automobiles to clear the intersection prior to sustaining damage from the crossing equipment.

Voltage drop and power demand calculations shall be made and submitted for review whenever more than two gates and/or cantilevers are used at a grade crossing. While on battery power, every flasher shall have a minimum of 90 percent of the original lamp voltage following the gate being raised and lowered three times.

Approaches shall be designed to ensure crossing warning equipment is operating at least 25 seconds before an express train occupies the crossing island circuit. Approach circuits for grade crossings shall be located for the running speed based on maximum permitted speed without consideration for LRT stations.

AREMA Communications & Signals Manual, Volume 1, Section 3, Part 3.3.10 shall be utilized in determining grade crossing timing and approach lengths. Additional time may be provided for advance preemption time (APT) provided the additional time does not result in longer grade crossing activation time. APT shall be determined by traffic signal engineer and accepted by the agency that will be accepting ownership of the traffic signals.

If a home signal is installed within the limits of an approach to a grade crossing, there shall be circuit ties between the grade crossing warning system and the signaling system that prevent a train operator from seeing a clear indication at the home signal and arriving at the crossing before the gates are in the down position. This situation can occur if a train is stopped at the

red indication and the indication turns green and the circuit ties do not exist. Circuit design shall be consistent with circuits used elsewhere on the system.

Gates that are in the down position for ten minutes will timeout and pick up. Upon activation of the grade crossing, the first signal in advance of a grade crossing approach circuit and any signal within the approach shall turn red and remain red until the approach circuit of the grade crossing clears.

Second train logic circuitry shall be provided to prevent gates from momentarily rising when a train is on the advance preemption approach circuit.

All new grade crossing flashers shall be Light Emitting Diode type.

Generally the use of four quadrant gates (exit gates) should be limited to quite zone and high speed rail corridor applications at which all alternative traffic management treatments that limit reverse entry to the crossing have been considered and due to unique features at the crossings under consideration the alternative treatments are considered to be ineffective at limiting reverse entry. When exit gates are utilized a vital traffic detection system shall be utilized to detect the presence of vehicles within the limits of the trackway crossing in accordance with best practices and all regulatory requirements at all crossings at which four quadrant gates are recommended for installation.

The railroads signal and traffic signal engineers shall work cooperatively in the development of a recommended grade crossing and traffic signal timing system that conforms to AREMA, MUTCD and CPUC requirements and standards. Since it is the traffic engineer's responsibility to manage the movement of highway vehicular traffic on the highway and therefore the traffic engineer has the final say on signal timing provided the timing conforms to AREMA, MUTCD, and CPUC requirements.

5.4.2 Crossing Equipment Layout Design Requirements

Every highway crossing warning system layout, including gates, flashers, and ancillary equipment, shall be designed with full regard to the particular railroad and transit operations at the particular crossing so as to minimize highway closure time. Gate placement shall conform to CPUC and CAMUTCD requirements while considering future street widening and double tracking plans.

Crossing gate mast shall extend high enough to accommodate clamp-on wind guard. A wind guard must be provided on all crossing gate masts to restrict horizontal gate arm movement in the vertical position and reduce breakage due to high wind.

Flashing lights shall have minimum 12-inch LED flashers per CPUC G.O. 75D.

Warning bells shall conform to AREMA Standards using "Soft Tone Clapper," mechanisms capable of producing 75 to 85 dBA.

Gates shall have a maximum length of 30 feet unless otherwise authorized by SANDAG and the system operator. At crossings where there are multiple lanes in one direction and there is a median that is 9 feet wide or wider with two or more lanes of traffic, a median gate shall be used. If possible, installation of a center median should be considered to discourage automobiles from driving around the gate. Warning device placement shall be determined by the diagnostic team. In no case shall a warning device be located less than 4 feet 3 inches from the face of the curb, or 6 feet 3 inches from the edge of traveled way at locations in which there is not a curb. Where gates are located at 4 feet 3 inches behind the curb or 6 feet 3 inches from the edge of traveled way and there is an existing sidewalk along the roadway, a walkway behind the gate shall be provided. The minimum width of the walkway shall be 4 feet clear of the gate counterweight assembly in the down position. The area under the counterweight shall not be paved. Special attention shall be made to the Americans with Disabilities Act (ADA) requirements. No part of the gate should protrude over the sidewalk when the gate is in the upright position, unless it is above 7 feet from the top of the sidewalk and a preferred minimum walkway width of 5 feet between obstructions should be maintained. Where space is limited the absolute minimum walkway width may be reduced below the preferred 5 feet minimum width and shall conform to the absolute minimum pathway width requirements of ADA. All gates shall be made of fiberglass. Under no circumstances shall a gate arm be made out of a conductive material such as aluminum.

When the area between the face of curb and edge of right of way does not provide sufficient space to create an ADA compliant walkway behind the gate counterweights when the gate is in the down position, then the gate position should be set back behind the sidewalk providing an ADA accessible path between the face of curb and the face of the gate assembly in the upright position. The design layout shall ensure that there is sufficient room within the right of way behind the gate mechanism to provide for the counterweights when the gate is in the down position. No part of the gate should protrude over the sidewalk when the gate is in the upright position, unless it is above 7 ft. from the top of the sidewalk and a preferred minimum walkway width of 5 ft. between face of curb and the nearest face of the gate (that is less than 7 feet above the planned finish surface) and other existing obstructions should be maintained. Where space is limited the absolute minimum walkway width may be reduced below the preferred 5 feet minimum width and shall conform to the absolute minimum pathway width requirements of Federal and State ADA requirements.

The diagnostic team should consider all of the existing right of way and other site constraints when developing the crossing layouts. Consistency of layout arrangement along a line segment should be given consideration by the diagnostic team. The ADA accessible walkways may pass between the gate and the roadway or behind the gate; it is the diagnostic team's responsibility to determine which arrangement is preferable at the crossing.

At locations in which a grade crossing is located adjacent to an interlocking, the signals shall be located on the nearside of the crossing so trains will stop prior to entering the crossing. In these situations the signal shall remain red until the gates have descended.

Gate mechanism shall be supported by a mast collar that prevents the mechanism from descending on the mast when gate mechanism mounting bolts are loosened to enable the mechanism to be rotated about the mast.

5.4.3 Utilization of Existing Equipment

Wherever the existing crossing gate and flasher assemblies are to be reused, all electrical equipment (wiring, motors, lights, etc.) shall be replaced as necessary.

5.5 Power

In an effort to limit the number of utility electrical services connection points, electrical power shall be obtained from a dedicated signaling system meter located at the closest secondary voltage electrical service point at a trolley station. Should special conditions require or enable power to be taken from a closer source than the trolley station, then the designer shall discuss the situation with the SANDAG system engineer and make a recommendation on how to proceed with the design. At locations where voltage drop may be an issue step up and step down transformers should be considered to overcome the voltage drop issue.

Designer shall submit voltage drop and load calculations with the 65% submittal. The voltage drop shall be calculated based on the maximum load of all equipment essential to the operation of the system. Load calculations shall not include the load of devices such as laptop computers, work lights, electric hand tools, and other devices that are not required to operate the system.

Designer shall provide all necessary information required to install new meter services where required. Designer shall coordinate design with the SDG&E utility coordinator.

5.6 Interface Requirements

5.6.1 General

The signal system shall be designed to properly interface with other major system elements such as civil facilities, trackwork, vehicles, utility and traction power, OCS, SCADA, and traffic signals.

5.6.2 Civil Facilities

The signal system shall be designed to properly interface with civil design elements including:

- Street crossings, including paving type conflicts with crossing controls;
- Platforms and accompanying structures;
- Wayside and street drainage;
- Overpass or underpass structures and bridges;
- Combined systems ductbank and pullboxes.

5.6.3 Trackwork

The signal system shall be designed to properly interface with trackwork design elements including:

- Horizontal and vertical alignment of tracks, including curves;
- Requirements for ballasted and embedded track;
- Ties and tie spacing at special trackwork and impedance bond locations;
- Locations of insulated joints;
- Special bonding for switches, frogs, and rail joints;
- Rail connections.

5.6.4 Vehicles

The signal system design shall be compatible with the vehicle characteristics described in Chapter 7, Vehicles. Track circuits shall be frequency coordinated with the different propulsion systems to assure proper operation of the track circuit.

5.6.5 Power

The signal system shall be designed to properly interface with the power utility including:

- Local utility sources and metering requirements;
- Power distribution requirements.

5.6.6 Traction Power Substations

The signal system shall be designed to properly interface with design elements of the traction power system including:

- Substation locations including negative connections to the track;
- Impedance bond locations;
- Crossbonding locations.

5.6.7 OCS

The signal system shall be designed to properly interface with OCS design elements including:

- Obstruction of signal views by poles or other OCS structures;
- Location of OCS insulated sections in coordination with any insulated joints in the trackwork below to avoid flash-overs.

5.6.8 Wide Area Network and Local Area Network

The signal system shall be designed to properly interface with the WAN/LAN communications system for interfacing with the Operations Control Center (OCC). Remote

signal and grade crossing locations shall be connected to the communication networks to provide signal system status to central control. The designer shall refer to Chapter 6, Communications for additional information.

The signal designer shall develop the fiber optic fiber allocations, splicing diagrams, Vital PLC, Vital Network Switch, and Vital fiber optic interfaces to ensure proper connectivity of the Vital WAN Fiber Optic Communication System.

The signal designer shall work with the Communications Systems engineers to show the placement of the Vital WAN cables on the same design drawings as the Non-Vital WAN communication system raceway and cabling allocation plans.

The signal designer shall coordinate non-vital LAN connections, IP addressing, and bit addressing with the non-vital communications WAN/LAN designer and CTC software integrator.

Prior to the 65% design submittal the signal designer shall provide a list of all signaling system catenary riser pole locations requiring spouts, second reinforced hand-holes, and conduit in the catenary pole foundation to the non-vital WAN/LAN designer and the Overhead Contact System (OCS) catenary designer.

Signal designer shall develop an OCC interface description that describes the changes required at the OCC to properly interface field signaling system elements for proper display at the OCC and to enable the proper control requests to be submitted to the field signaling system controller. OCC interface description shall include new signaling system layout, existing signaling system layout identifying items to be removed, new and to be removed track circuits bit information, new and to be removed signal indications bit addresses, new and to be removed route request bit information, and all other interface bit addressing required to provide a fully functional system that provides desired functionality that is consistent with the existing system at OCC, unless otherwise directed.

5.6.9 Traffic Signals

- The signal system shall be designed to properly interface with traffic signal design elements located at or near to grade crossings. The systems shall be designed to conform to American Railway Engineering and Maintenance-of-Way Association (AREMA) Communication and Signal Manual of Recommended Practices and the California Manual of Uniform Traffic Control Devices (CAMUTCD). The signal designer shall:
 - Coordinate with the appropriate city traffic agencies;
 - Obtain advanced or simultaneous preemption requirements from the local traffic agency;
 - Pay special attention to flashing signals, striping and signage governing left turns from parallel moves.

6.0 COMMUNICATIONS

The system utilizes a variety of communications applications for a variety of purposes. Unless otherwise directed, the systems designs shall remain compatible and consistent with existing communications systems. As technology evolves, SANDAG and MTS want to take advantage of the advancements in technology. Designers should meet with staff and share potential advancements to discuss incorporation of these technologies into the project.

This chapter provides the designer with information about the existing communications systems, guide the design process, in an effort to ensure that quality designs are created by the design engineer's. This chapter describes the functional, performance, and interface requirements and criteria of Communications systems to be incorporated into San Diego Metropolitan Transit System (MTS) Light Rail Transit (LRT) Projects.

The Communications System contract plans and Special Provisions shall consist of the following systems: Wide Area and Local Area Networks (WAN/LAN), communications enclosures and rooms; fare technology provisions; wireless radio; public address (PA), visual message sign (VMS) provisions; telephone; intrusion detection; temperature control; station and parking lot video surveillance; traction power and railway signaling supervisory control and data acquisition (SCADA); Bi-directional Vehicle and Wayside Communications (BVWC); communications room access control system(if applicable); uninterruptible power supply (UPS); and grounding and bonding. Should the contract plans include Enclosed Structures (such as underground station), then the communications system design contract plans and Special Provisions shall also include Emergency Management Panel (EMP) with fire response SCADA features, fire alarm, and intrusion detection systems.

The WAN/LAN are utilized by many other systems to transport data associated the other systems and required to function. Designers shall ensure that all system designs are compatible with the existing network and all modifications to the WAN/LAN and Control Systems at the OCC will be consistent and fully compatible with all existing systems to ensure new system and system modifications will be fully functional once implemented. Any additional required interfaces shall be identified and a plan developed to integrate the additional interfaces into the existing OCC and WAN/LAN systems to ensure complete functionality following testing and commissioning. Interface requirements shall be logged and tracked to help ensure that the requirements are completed. This chapter's interface descriptions are not in complete detail. Rather, they are intended to provide general interface information and guidance to ensure new interfaces are compatible and consistent with existing network interface design practices.

Plans and Special Provisions for systems listed above shall be consistent to those developed for recent SANDAG projects of a similar type and conform to the requirements described herein, unless otherwise directed by the SANDAG System Engineer. Any and all direction received that is not consistent with requirements specified in this design criteria shall be followed and confirmed through written correspondence with the SANDAG Systems Engineer and SANDAG Project Manager. Should any direction received be perceived to be beyond the scope of services authorized, then the designer shall, prior to starting work, seek written authorization to

proceed with the design work from the SANDAG Project Manager.

As technology evolves and improves and new products are released, there may be opportunities to improve the system beyond the technology level described in this document. The Designer shall early in the design development phase identify areas for advancement and notify the SANDAG project manager and the SANDAG Systems Engineer, present information about these system, and request direction on whether or not MTS and SANDAG are interested in pursuing the recommended technology.

Should SANDAG's project manager or the SANDAG Systems Engineer determine that the technology is worth presenting to MTS for consideration, then the designer shall be present the technology and costs associated with it. SANDAG and/or MTS may request additional meetings with qualified vendors to obtain additional information and potentially request a demonstration of the technology under consideration.

6.1 General

Designers shall develop designs that conform to the requirements contained in this Design Criteria, are consistent with the most current update to the Standards Plans, and Special Provisions and plans utilized for recent projects.

Communications Systems Design Plans shall include at a minimum:

- Cover sheet and Index of Drawings;
- Abbreviations, Symbols and Legend sheet;
- General Notes and References;
- Demolition plans showing items to be removed (if needed);
- Raceway and cable location plans on topographic sheets identifying location and type of enclosures, down guys anchor assemblies, down guy anchor foundations, and raceways to be installed (including aerial, underground, riser, junction box, and cable trays);
- Single line diagrams for each communications system to be installed;
- Man holes, hand holes, and pull boxes cable termination schedules;
- Typical details for assemblies;
- Aerial signaling and fiber optic cable schedules;
- Splicing diagrams;
- Communications enclosure, building, or room details;
- Initial and final rack layouts;
- Station communication raceway drawings;
- Equipment termination schedules and detail sheets.

Except as specified otherwise, exterior metal communications system fabrications and hardware shall conform to the requirements of Sections 75, “Miscellaneous Metal” and 75-1.05 “Galvanizing” of the Caltrans Standard Specifications.

Concrete reinforcing steel shall conform to the provisions in Section 52, “Reinforcement,” of the Caltrans Standard Specifications.

Communications system computer aided drawing files shall be provided by the designer to SANDAG Systems Configuration Manager. The Construction Contractor shall update design drawings with as-built information and submit final drawings for the installed system.

6.1.1 Communications Systems Overview

The San Diego Trolley Light Rail Communications systems are primarily intended to facilitate both verbal and digital communications exchange between the Operations Control Center (OCC) and passenger stations, field equipment and between the OCC and on board vehicle equipment. The communications system shall provide the necessary sub system to support the total operation requirements of the LRT system.

6.1.1.1 Digital Communications

All digital communications between the OCC and field devices utilize a backbone fiber optic cable transmission system with Transmission Control Protocol and Internet Protocol (TCP/IP) to communicate over the Wide Area Network (WAN) and the Local Area Network (LAN).

The digital WAN and LAN communications systems are also utilized by the Fare Technology and Video Surveillance Systems.

In addition, the fully integrated Advanced Inventory Management System (AIMS) is a Supervisory Control and Data Acquisition System (SCADA) located at the Operation Control Center (OCC) that interfaces with field elements to display information at the OCC. The AIMS SCADA system interfaces with the following systems over the WAN and LAN:

- Railway Signaling (track circuits occupancy, indications, route requests, cancel, track blocks, etc.);
- Traction Power System (Voltage, Current, DC and AC breakers Open/Closed, Line Energized De-energized, etc.);
- Passenger station facilities such as elevators or escalators, electric power meter, UPS back up battery.etc;
- Unidirectional Train to Wayside (TWC) and Bi-directional Vehicle and Wayside Communications (BVWC), commonly referred to as Bidirectional TWC, System (Train number, route number, time stamps, etc.);
- Wheel Counter System (In-street running areas only, e.g. C Street, Park Blvd, Commercial, and Cuyamaca);
- Variable Message Signs (VMS) (messaging at stations (next train, canned, etc.));
- Public Address Systems (PA) (audio messages at stations);
- Intrusion Detection and temperature Monitoring PLC

Line extension and capital improvement projects shall upgrade the AIMS software and OCC hardware as needed to fully integrate the new line extension into the existing AIMS OCC facility. Prior to the new line being placed in service the OCC AIMS system shall be upgraded to enable all existing functionality to be extended to the new line segment. The systems deployed along the new line extension shall provide the same functionality and utilize the same interface protocols and bit assignments as the existing system utilizes to interface the existing AIMS system. All new field equipment shall conform to the MTS vital and non-vital IP addressing standard. Designers shall meet with San Diego Trolley Operations and SANDAG systems engineers to determine if any additional functionality is desired. If so, then the designer shall incorporate these new requirements into the Contract Documents.

The Line Extension (LEP) or Capital Improvement Project (CIP) design consultant shall incorporate interface parameters that define the interface protocol, bit assignments, and IP addressing standard in conformance with MTS and SANDAG standards and current practices. The designer shall contact the SANDAG Project Manager to determine if the Contractor will be required to update the AIMS Software at OCC or if it will be handled under a separate SANDAG or MTS contract. Regardless, all interface requirements shall be defined by the LEP or CIP design consultant.

All field elements shall be connected with the OCC over a physical Single Mode Optical Fiber cable or outdoor rated Category 6 cable, unless otherwise approved in writing by the SANDAG systems engineer for a site specific application where all hard wire alternatives are not practical.

6.1.1.2 Vehicle to Wayside Wi-Fi Wireless Local Area Network Communications

Vehicle to Wayside IEEE 802.11 Wi-Fi Wireless Local Area Network (WLAN) communications consisting of equipment fully compatible with the equipment on the existing system shall be included in the design at stations and along the corridor to provide real time communications between the vehicle and wayside. This wireless network shall be designed to use the fiber optic WAN and LAN facilities along the trolley lines as the path of communications between the OCC and digital wireless radio transceiver units located along the light rail corridors. See Section 6.19 "Vehicle to Wayside Wi-Fi Wireless local Area Network Communications" for additional information.

6.1.1.3 Voice Radio Communication System

Currently San Diego Trolley Communicates with light rail vehicle operators over an analog radio system that is described in Section 6-8, Radio Communications section below.

Prior to the 35 percent submittal the LEP designers shall meet with the SANDAG Project Manager, the SANDAG systems Engineer, and MTS San Diego Trolley Operations staff to: a) review existing radio system parameters; b) confirm all new equipment shall be capable of both Analog and Digital Communications; and c) determine if existing units require upgrading in order to properly interface with new equipment needed for the expanded radio system required to provide adequate coverage over the limits of the LEP. The portable radio shall have sufficient operation channel with effective radio coverage for maintenance personnel while travel on major freeways or expressways to service equipment at passenger station and TPSS.

6.1.2 Definitions and Terms

The definitions and terms provided in Section 1, “Definitions and Terms,” of these Special Provisions, and as specified below, shall apply to all work covered by this section of the Design Criteria unless otherwise specified in these special provisions.

Aerial Storage Assembly: An arrangement designed for holding excess FOC slack in an aerial span of FOC. The aerial storage assembly allows the user flexibility in equipment location and the ability to access the cable slack to break out optical fibers or re-splice cables.

Breakout: The cable “breakout” is produced by 1) removing the jacket just beyond the last tie-wrap point; 2) exposing 1 to 2 meters of the cable buffers, aramid strength yarn and central fiberglass strength member; and 3) cutting the aramid yarn, central strength member and the buffer tubes to expose the individual glass fibers for splicing or connection to the appropriate device.

Bi-directional Vehicle and Wayside Communications (BVWC): A two-way radio communication system between vehicle and wayside equipment, commonly known in the industry as Bi-directional Train to Wayside Communications “Bi-direction TWC”.

Coastal: Areas located within 5 miles of a body of water containing Pacific Ocean salt water.

Connector: A mechanical device used to align and join two fibers together to provide a means for attaching to and decoupling from a transmitter, receiver, or another fiber (patch panel).

Connectorized: The termination point of a fiber after connectors have been affixed.

Couplers: Couplers are devices which mate fiber optic connectors to facilitate the transition of optic light signals from one connector into another. They are normally located within FDFs mounted in panels. They may also be used unmounted, to join two simplex fiber runs.

Deutsches Institut für Normung (DIN) (in English the German Institute for Standardization): A Registered German Association headquartered in Berlin that develops technology standards for Germany.

Device (Network): A machine, mechanism, or electronic equipment used to serve a purpose and connected to the Local Area Network. Some examples of network devices include: Ticket Vending Machines, Passenger Card Interface Devices, Variable Message Signs, Video Surveillance Cameras, Axel Counters, and Programmable Logic Controllers.

European Standards (EN): are documents that have been ratified by one of three European Standard Organizations: a) the European Committee for Standardization (CEN); b) the European Committee for Electro technical Standardization (CENELEC); or c) the European Telecommunications Standards Institute (ETSI).

Electronic Industries Alliance (EIA): is a trade organization composed as an alliance of trade associations for electronics manufacturers in the United States. Those associations in turn govern sectors of EIA standards activity. EIA is accredited by ANSI to help develop standard on electronic components, consumer electronics, electronic information, telecommunications, and Internet security.

Fail-safe Principle and Practices: In accordance with the description provided in Part 16 of the American Railway Engineering and Maintenance-of-Way Association (AREMA), Communications & Signals Manual of Recommended Practices.

Fiber Distribution Frame (FDF): A rack mounted system that consists of a standard equipment rack, fiber routing guides, horizontal jumper troughs and Fiber Distribution Unit (FDU).

Fiber Distribution Unit (FDU): Is an enclosure or rack –mountable unit containing both a patch panel with couplers and a splice tray(s).

F/O: Fiber optic.

FOC: Fiber optic cable.

FOIP: Fiber optic inside plant cable.

FOTP: Fiber optic test procedure(s) as defined by EIA/TIA standards.

Headroom (audio): The difference between the nominal signal value and the maximum undistorted value.

Indications: Defined in Title 49 of the Code of Federal Regulations Part 236.749.

Interior: Pertaining to the space within an enclosure or room in a temperature controlled environment.

Interlocking, Automatic: Defined in Title 49 of the Code of Federal Regulations Part 236.750.

Jumper (Patch Cord): A short fiber optic cable that has connectors installed on both ends, and is typically used for connection within a FDF.

Local Area Network (LAN): The portion of the communications network that includes the Network Switch at a trolley station, Ethernet cablin, and all field devices communicating thru it.

Light Source: Portable fiber optic test equipment that, in conjunction with a power meter, is used to perform end-to-end attenuation testing. It contains a stabilized light source operating at the designed wavelength of the system under test.

Link: A passive section of the system, the ends of which are to be connected to active components. A link may include splices and couplers. For example, a video link may be from a F/O transmitter to a video multiplexer (MUX).

Link Loss Budget: A calculation of the overall permissible attenuation from the fiber optic transmitter (source) to the fiber optic receiver (detector).

Loose Tube Cable: Type of cable construction in which fibers are placed in filled buffer tubes to isolate them from outside forces (stress). A flooding compound is applied to the interstitial cable core to prevent water migration and penetration. This type of cable is primarily for outdoor applications.

Non-vital: The name given to systems which are not Safety-critical systems and are not required to be in conformance with the railway signaling systems Fail-safe Principle and Practices.

Optical Time Domain Reflectometer (OTDR): Fiber optic test equipment (similar in appearance to an oscilloscope) that is used to measure the total amount of power loss between two points and the corresponding distance. It provides a visual and printed display of the relative location of system components such as fiber sections, splices and connectors and the losses that are attributed to each component or defect in the fiber.

Patch Cord (Jumper): A short jumper used to create a communications path typically connecting a patch panel to a device. Cords are typically either: a) a single mode fiber optic patch cord with SC or other connector, or b) a Category 6 Ethernet cable with RJ-45 connectors.

Pigtail: Short fiber optic cable that has a connector installed on only one end.

Power Meter: Portable fiber optic test equipment that, in conjunction with a light source, is used to perform end-to-end attenuation testing. It contains a detector that is sensitive to light at the designed wavelength of the system under test. Its display indicates the amount of power injected by the light source that arrives at the receiving end of the link.

Railroad: Defined in Title 49 of the Code of Federal Regulations Part 236.787a.

Riser: A vertical run of fiber optic cable in rigid galvanized steel conduit typically firmly attached to pole or wall faces.

Redundant Network: A network configuration that will reroute information by way of a predetermined alternative route if the primary information path is determined to be interrupted.

Safety-critical: Defined in Title 49 of the Code of Federal Regulations Part 236.903.

Segment: A section of FOC that is not connected to any active device and may or may not have splices per the design.

Splice: The permanent joining of fiber ends to matching fibers.

Splice Closure: Normally installed in a splice vault or in an aerial FOC span is an environmentally sealed container used to organize and protect splice trays. The container allows splitting or routing of fiber cables from multiple locations.

Splice Module Housing (SMH): The SMH stores splice trays as well as pigtails and short cable lengths.

Splice Tray: A container used to organize and protect spliced fibers.

Splice Vault: A splice vault is used to house splice closures.

Splice Module Housing (SMH): The SMH stores splice trays as well as pigtails and short cable lengths.

Storage Cabinet: Designed for holding excess cable slack for protection. The storage cabinet allows the user flexibility in equipment location and the ability to pull cable back for re-splicing.

Vital: The name given to Safety Critical, railroad signaling systems that are designed in accordance with Fail-safe Principles and Practices so that whenever an equipment failure or adverse environmental condition affects the specified operation of a system involved with safety, the system shall revert to a state known to be safe.

Wide Area Network (WAN) (Non-vital): The communication IT network portion of the communications that connects Central Control network switches and the network switch at each trolley station.

Wide Area Network (WAN) (Vital): The rail operation network information that connecting Vital Railroad Signaling System programmable logic controllers (PLCs) together and to the maintenance-of-way facility.

6.1.3 Environment

Unless otherwise indicated, all communications system material and equipment shall be capable of being operated and maintained without impairment resulting from the impact of the environment through the range of worst case values indicated in the table below. "Exterior" shall be defined as applying to all locations except those that are "interior" or "tunnel". "Interior" shall be defined as all locations in a communications room inside a structure, communications enclosure, or prefabricated communications building. "Tunnel" shall be defined as locations in underground facilities supporting an underground light rail vehicle guideway.

Table 6-1. – Environmental Operating Range

	Exterior	Tunnel	Interior
Operating Temperature	15°F (-9°C) to 130°F (54°C).	15°F (-9°C) to 130°F (54°C).*	32°F (0°C) to 95°F (35°C).*
Relative Humidity	10 to 100 percent including conditions of condensation.	10 to 100 percent including conditions of condensation.	10 to 95 percent
Maximum Rainfall	4 inches (10 cm) in 24 hours, and 1-1/2 inches (4 cm) in one hour.	0 inches	0 inches
Maximum Wind Velocity	Per latest edition of the California Building Code (CBC)	Per latest edition of the California Building Code (CBC)	Not applicable.
Vibration (Near Trackway)	All frequencies less than 12 Hz, 0.02 inches peak to peak amplitude; all frequencies from 12 Hz to 1,000 Hz, 0.14 g peak or 0.19 rms.	All frequencies less than 12 Hz, 0.02 inches peak to peak amplitude; all frequencies from 12 Hz to 1,000 Hz, 0.14 g peak or 0.19 rms.	All frequencies less than 12 Hz, 0.02 inches peak to peak amplitude; all frequencies from 12 Hz to 1,000 Hz, 0.14 g peak or 0.19 rms.
Seismic	Per latest edition of the California Building Code (CBC)	Per latest edition of the California Building Code (CBC)	Per latest edition of the California Building Code (CBC)
Lightning	Isokeraunic level will be five per year.	None	None

* The temperature range for Digital Video Recorders and Uninterruptable Power Supplies (UPS) located within Air Conditioned enclosures or enclosures within a tunnel located below the earth's surface shall conform to an operating temperature range of 32 degrees F (0 degrees C) to 104 degrees F (40 degrees C).

Designer shall develop designs that locate communications systems controls in insulated air-conditioned enclosures with transient voltage surge suppression, temperature and intrusions sensing and alarms, and at least a 100 amp subpanel, sized to accommodate all current and future systems plans for the site and will be considered to be an environmentally controlled environment.

Sizing of environmentally controlled environments shall provide:

- Adequate space in the 19 inch racks for all equipment associated with the ultimate configuration plus 20 percent spare rack space;
- Electrical provisions for ultimate load plus 20 percent spare capacity;
- Temperature control adequately sized to handle heat generation from all current and future equipment plus heat from the sun on the hottest day of the year.

Communications systems equipment residing outside of an environmentally controlled enclosure whenever feasible and practical shall be industrial grade equipment.

Equipment residing in railway signaling enclosures shall conform to the AREMA Communications and Signaling system standards.

6.1.4 Regulations, Codes, and Standards

All electrical equipment shall conform to the standards of the National Electrical Manufacturers Association (NEMA), the Underwriter's Laboratories Inc. (UL), the Electrical Testing Laboratories (ETL), wherever applicable. In addition to the provisions of this Design Criteria, all materials and workmanship shall conform to the requirements of the California Electric Code (CEC), herein referred to as the Code; California Code of Regulations (CCR), Title 8, Chapter 4, Subchapter 5, Electrical Safety Orders; Rules for Overhead Electrical Line Construction, General Order (GO) No. 95 of the California Public Utilities Commission (CPUC); Standards of the American Society for Testing and Materials (ASTM); American National Standards Institute (ANSI) and any local ordinances which may apply.

Wherever reference is made to any of the standards mentioned above, the reference shall be construed to mean the code, order, or standard that is in effect on the day the Notice to Contractors for the work is dated.

The following Codes and Standards are referred to by reference in this Design Criteria and should be utilized and referenced as appropriate to ensure a quality installation when developing contract plans and Special Provisions for projects:

- American Iron and Steel Institute (AISI);
- American National Standards Institute (ANSI);
- American Railway Engineering and Maintenance of Way Association (AREMA);
- Americans with Disabilities Act (ADA);
- Americans with Disabilities Accessibility Guidelines (ADAAG);
- California Building Code (CBC);
- California Public Utilities Commission (CPUC) General Orders (GO);
- Electronic Components Industry Association (ECIA) (maintainers of the EIA standards);
- Electronic Industries Alliance (EIA) standards;

- Federal Communications Commissioning (FCC);
- Flat Glass Marketing Association (FGMA);
- Institute of Electrical and Electronics Engineers (IEEE);
- Insulated Cable Engineers Association (ICEA);
- International Electrotechnical Commission (IEC);
- International Municipal Signal Association (IMSA);
- International Organization for Standardization (ISO);
- International Telecommunication Union (ITU);
- National Electric Code (NEC);
- National Electrical Manufacturers Association (NEMA);
- National Fire Protection Agency (NFPA);
- Telecommunications Industry Association (TIA);
- Underwriters Laboratories, Inc. (UL).

All Communications Systems shall be constructed in accordance with applicable CPUC and ADA laws. See CPUC GO and ADAAG section 10 for details.

6.1.5 Industry Standard Practices

Unless otherwise directed by SANDAG, designers shall incorporate industry best practices to ensure quality and performance industry standards are achieved.

6.1.6 Testing, Commissioning, and Acceptance Requirements

All contract Special Provisions shall include acceptance testing criteria that define tests to be performed and acceptance criteria that will ensure a quality product. In addition, contract specifications shall include additional test requirements at factory, on-site following shipment prior to installation, and post installation to ensure deficiencies are identified at the earliest time to mitigate potential impacts to the delivery schedule. Contract Special Provisions shall also described the commissioning process and work to be performed by the Contractor during the commissioning process.

6.2 Operations Control Center

The Operations Control Center (OCC) facility is comprised of: a) Operations Control Center – Controllers and Security Control Room, b) OCC Communications Room, c) OCC Mechanical Room, d) the OCC Electrical Room containing (UPS and Fire Life Safety Systems), and e) exterior HVAC condenser and power generation units.

6.2.1 Operations Control Center - Centralized Train Control

Within the OCC Controllers manage the dispatching and operations of the trolley system. On wall mounted displays the entire territory of the light rail system is displayed. The AIMs Centralized Train Control (CTC) system, developed by MTS OCC systems integrator (Arinc),

is a fully integrated Supervisory Control and Data Acquisition (SCADA) system that enables Controllers to obtain real time status information and interface with or control all of the following field systems:

- Signaling System: Indication Status, Track Circuit Status, Established Route Status, Canceling of Established Routes, Submission of Route Requests, and other related functions;
- Traction Power System: Line Voltage Status, Direct Current (DC) Breaker Control and Status (open/closed), 12 kV AC Breaker Control and Status (open/closed); Transfer Trip Status and DC Breaker Control; and other related functions;
- Public Address (PA): Control of Announcements at Stations (live, canned, etc.) from the OCC via the communication back bone;
- Visual Message Signs (VMS): Control of digital Visual Message Signs displays to display: special announcements; full automated destination and next train messaging information; and other related functions;
- Fire detection alarm, indication and control signals;
- Tunnel ventilation alarm, indication and control signals;
- Intrusion and temperature alarms; and
- Fare Collections.

Within the OCC security personnel are able to access real time live streaming video from video surveillance cameras located at stations throughout the trolley system. This fully integrated video surveillance system enables any system operator to view any camera at any and every trolley station.

The SCADA LAN at OCC shall communicate with the PLC at stations and TPSSs to monitor field's devices from the OCC consoles.

Within the OCC Line Supervisors and security personnel shall be able to communicate with supervisors, vehicle operators, security guards, and maintenance of way personnel via the Radio Communications System (RCS).

6.2.2 Evaluation of OCC Facility Modifications Required to Support Territorial Expansion

Line segment system designers of the light rail territorial expansion project shall evaluate all existing OCC facilities and develop recommendations on upgrades or substantive overhaul to the existing facility required to accommodate the new territory of the expanded light rail system. These recommendations shall be submitted in draft form to the SANDAG Project Manager, SANDAG System Engineer, SANDAG Director of Rail, MTS Systems Engineer, SDTI Director of Operations, and the MTS Chief Technology Officer for review and comment before being finalized. All review comments shall be reviewed and discussed at a review meeting with the designer and all of the parties listed above invited to attend.

Designers of new territory, new line segments or line extension projects, shall analyze every part the existing OCC facility described above and make recommendations of additional enhancements or substantive overhaul to the OCC in order to provide a fully integrated CTC,

video surveillance, and RCS system with full functionality and complete coverage of the new territory. These enhancements or substantive overhaul recommendations shall review all operational, functional, interface, and spatial needs required to fully integrate the new territory into the existing OCC facility.

The evaluation of the existing OCC facility shall be a comprehensive review of the complete facility, including Line Supervisor and security workstation adequacy to support the new territory.

The evaluation shall review life expectancy, capacity adequacy, efficiency, expandability, and potential regulatory compliance issues with the existing systems and facilities.

If the existing OCC communication systems (WAN, LAN, CTC and RCS network servers, displays, microphones, control workstations, RCS radio equipment, rack space, etc.), electrical UPS, fire alarm and suppression, and mechanical equipment is: a) no longer being manufactured; b) does not comply with to the latest regulatory requirements and more restrictive standards; or c) will be over 10 years old by the time the line extension or new line is planned to being revenue service, then the designer shall recommend a substantive overhaul to the existing system. The designer shall identify all components requiring overhaul and prepare a scope of work with cost estimate for the work required to substantively overhaul the existing communication system.

If it is determined that existing system only needs to be enhanced such as increase capacity to accommodate the new extension line with additional links, then the designer shall develop and submit recommendations with cost estimates to the project manager detailing ways to link the project area to the SANDAG project manager and SANDAG systems engineer for approval. The designer shall include in the design of the system the new communication links required.

The designer shall also make recommendations regarding technological changes that should be considered that would improve the system and ensure the system remains compliant with current industry standards and requirements.

Build-Out expanded coverage shall be part of the light rail system expansion planning. To do this expansion planning of each system shall be performed for each of the control systems: WAN, LAN, RCS, Video Surveillance, fully integrated CTC (including Railway Signaling System, PA and VMS system interfaces). The expansion planning shall identify additional equipment needs and associated rack space required.

OCC spatial equipment needs shall review existing conditions and provide revised equipment rack layouts. Analysis of the OCC needs shall be performed in conjunction with other OCC system upgrades required to accommodate the new light rail territory and other planned enhancements to the OCC, including but not limited to Centralized Train Control (CTC), VMS, PA, and Video Surveillance systems enhancements.

If the existing racks in the OCC communications room do not have sufficient space to accommodate the new equipment and/or there is not sufficient space for additional workstations required to operate the new territory, then the designer shall review the existing OCC facility and develop recommendations on how to expand the existing facility to

accommodate the new equipment and work-stations. The OCC facility expansion planning shall review the adequacy of all electrical, mechanical, fire life safety, communications, and control rooms and make recommendations and prepare cost estimates of the changes to the OCC required to support the expanded light rail system territory.

The planning effort shall provide a site plan of the expanded OCC facility with dimensional information of all equipment rooms in the expanded OCC facility and rack layouts of all new systems equipment required to upgrade the OCC to fully integrate the new territory.

6.2.3 Design Development of OCC Facility Modifications Required to Support Territorial Expansion

Line Segment Designers shall prepare OCC Facility Modification Contract plans, specifications, and estimates to incorporate all facility modifications required to support the light rail territorial expansion in accordance with the direction provided by SANDAG and MTS staff.

6.3 Station Communications Enclosures, Buildings, and Rooms

6.3.1 General

Every Station shall include a Communications Cabinet, Prefabricated Communication Building, or Communications Room in accordance with the requirements of this section. Additional communications enclosures shall be added at additional locations when directed by SANDAG.

Station communications equipment shall be located inside a communications cabinet, building, or room and will consist of WAN and LAN switches, routers, power strips, power supplies, fiber optic distribution panels, and copper/fiber cabling; public address equipment, video surveillance equipment, and other SCADA systems equipment.

When designs specify new equipment to be installed in new equipment racks in communications equipment rooms, the equipment and all cross-connect panels shall be of modular design and required to be preassembled and wired to the greatest extent possible to limit the amount of on-site wiring and testing, whenever it is practical for the work to be implemented using this approach.

6.3.1.1 Grounding and Surge Suppression

Communications cabinets, buildings and rooms shall be provided with surge suppression on the AC power distribution system as specified in Section 6-14 "Surge Suppression".

6.3.1.2 Programmable Logic Controller

Communications cabinets, buildings or rooms shall be provided with a rack mounted programmable logic controller (PLC) unless directed otherwise by SANDAG. The PLC shall be a GE RX3i controller or approved equivalent and shall be programmed with software that is consistent with that utilized at other locations on the system. The PLC is to provide input and outputs for control and monitoring of Station equipment. Refer to the SANDAG Standard Plans for Typical PLC Wiring Diagram.

The PLC shall include a PLC Accessory Enclosure that houses a 24 VDC power supply, terminal blocks, and the UPS Dry Contact I/O Accessory. The PLC Accessory Enclosure is to be mounted on the plywood backboard.

Provide devices, raceways and wiring for a complete operating system. Sensors shall be wired to the PLC Accessory Enclosure and provides inputs and outputs to the PLC input/output (I/O) ports.

The CTC vender will furnish software upgrades to the OCC and provide software for load into the RX3i PLC. The RX3i installation contractor shall be responsible for loading the SANDAG furnished software into the PLC.

The designer shall provide a PLC coordination document identifying the system interfaces and functional requirements at each communications enclosure location (e.g. communications cabinet, communications building, or room). Report shall include all pertinent information required for the SANDAG AIMs system integrator to develop functional software both at the Operations Control Center and for download into the PLC at the station including, but not limited to: IP addressing, sensor input and output descriptions (type, circuit configuration exhibit, port designations), and a functional description of the response to each change of sensory input (i.e. alarm, alarm prevention, shut down response, etc.). As part of the coordination report the designer shall provide a cost estimate for the software development effort. The coordination report will be used to assist SANDAG with development the scope of work for the AIM system software integrator.

6.3.1.3 Locating Communications Cabinets or Buildings

Communications enclosures shall be located either at the far end of the station as determined by the normal movement of trolleys on the nearest track, unless the SANDAG Systems Engineer determines there a site specific constraint that requires it to be place otherwise. For the purposes of this section the normal movement shall be defined as right hand running. When facing the track, the Communications enclosure shall be at the right hand end of the station platform. The preferred position of the Communications enclosure is with the long side oriented parallel with the tracks and the back face of the enclosure even with the back edge of platform. If located at the platform, the minimum communications enclosure off set from the centerline of the nearest track shall not be less than 15 feet to nearest face of the communications enclosure, unless site specific constraints exist and a deviation is granted by the Director of Rail. The goal is to minimize obstructions to the line of sight of light rail vehicle operators traveling along the trackway and pedestrians preparing to cross the tracks at the crosswalks at the stations. Communications enclosures shall be set a minimum of 5 feet from face of curb of a parking lot or other vehicular area. If the 5 feet minimum offset is unable to be accommodated, then “Barriers” shall be added and conform to the requirements described in Section 604.1A of the SDG&E Service Standards & Guide.

6.3.1.4 Communications Cabinet, Building and Room Foundations

Foundation designers shall utilize available geotechnical testing data and structural engineering analysis to develop foundation designs that are suitable to support the communications enclosure in accordance with California Building Code requirements.

If any of the enclosures are required on elevated structures, provisions shall be incorporated into the design of the elevated structures to ensure the cabinets are accessible and include necessary details for mounting them on the structure.

6.3.2 Communications Cabinet, Building and Room at Standard Stations

Unless unique site specific needs require additional non-standard equipment at a standard non-enclosed station with up to two platforms, then station shall have either: a) Three Bay Communications Enclosure, b) Prefabricated Communications Building, or c) Communications Room meeting the requirements described below.

6.3.2.1 Communications Cabinet - Three Bay Communications Enclosure

The Three Bay Communications Enclosure shall conform to the following:

- **Enclosure Construction**

Each enclosure shall be equivalent to the existing cabinets on the light rail system. Each shall have the equipment layout in the 19 inch racks and plywood back panel in the same configuration that is used at existing station locations, unless otherwise approved for each specific site.

Each enclosure shall be a rainproof cabinet with dimensions as shown on the plans. The cabinet top shall be slanted to the rear to prevent standing water.

Each three bay communications enclosure shall be 108 inches in length, 72 inches tall, and 36 inches deep manufactured of AISI 316 Stainless Steel Sheet in accordance with Section 86-3.04 A "Cabinet Construction" of the Caltrans Standard Specifications, except as otherwise specified herein.

Enclosures shall be constructed of 14-gauge stainless steel in conformance with Section 86-3.04A, "Cabinet Construction" of the Caltrans Standard Specifications, except as otherwise specified here in. If the Contractor would prefer to use an alternative equivalent AWS welding method to weld the communication cabinets, then the Contractor shall submit the equivalent welding method to the Engineer in writing for approval. In order to be considered to be an equivalent process the alternative AWS welding methods shall: a) conform to an American Welding Society (AWS) standard process, b) result in a quality weld, and c) shall result in a weld that will not rust. The Engineer shall be the sole judge as to the quality and suitability of the alternative welding method, and the Engineer's decision shall be final.

All hardware, including locks and fasteners, shall be of AISI 316 stainless steel, designed for a coastal salt-fog environment. Environmental protection shall meet the requirements for Type 4X enclosures in the NEMA Enclosure Standards. Door locks shall be able to be locked with a pad lock.

Exterior welds shall be ground smooth. Edges shall be filed to a radius of 0.03 inches minimum.

All enclosures shall be designed and installed with brackets and bolt downs to the reinforced concrete slab to support the equipment racks, air conditioning, electrical load

center, surge suppression assembly and comply with the site's seismic design requirements in the California Building Code and as shown on the plans.

All new enclosures shall be insulated with an R value of 4.

Each three bay communications enclosure shall have three equipment bays (center and a bay on either side). The center bay shall have a swing out 19-inch rack with at least 33 useable rack units of space. Each of the other bays shall have 19-inch four post free standing racks conforming to the site's seismic design requirements in the California Building Code and the requirements described in Telcordia Technologies Generic Requirements (GR) GR-63. All of the racks shall be tapped with standard 12-24 holes spaced in accordance with CEA-310-E (EIA-310-D) standard. Threading shall conform to the ANSI B1.1, Unified Course Thread (UNC) standard.

Cabinet shall provide space on the back board for up to 200 feet of coiled FOC for each run terminating in the cabinet.

Cabinet shall have fiber-optic cable entry and shall be supplied with standard cable storage brackets or a reel with a minimum radius of 15 times the FOC diameter for storage.

- **Enclosure Air Conditioning System**

Each communications cabinet shall have an Air Conditioning (AC) Unit (McLean T-50 series or approved equivalent), mounted on the side of it that conforms to the following and consistent to those used on the existing system:

- Designer shall determine and develop technical specifications based on calculation of the AC unit based on anticipated environmental and equipment heat generation values;
- Thermostat setting shall not be higher than 85 degrees;
- Mount to cabinet shall have a rubber gasket to create leak-proof seal between heat exchanger and communications cabinet;
- Have a 316 Stainless Steel enclosure Underwriters Laboratories, UL 50, NEMA4 or greater rating for outdoor environments;
- Utilize CFC- Free Refrigerant;
- Suppress electromagnetic interference (EMI) and radio frequency interference (RFI);
- Designer shall specify an electrical voltage and electromagnetic wave length (in hertz) ratings that are compatible with and enable the unit to utilize power from the existing electrical service at each station without transformation thru other devices. The Designer shall contact the Utility Company via the SANDAG utility coordinator and conduct a field survey to determine proper sizing prior to developing the specification for the enclosure electrical subpanel and Air Conditioning System. Whenever possible, the Designer shall specify the AC unit with the highest voltage rating available from the cabinet's electrical load center. In most cases, the new air conditioner unit should have a voltage rating of 200 volts or higher. Current flow shall not exceed 25 amps when operated at ambient temperature of 130° F;

- Be constructed of materials that protect against internal and external corrosion in salty, wet environments;
- Temperature Control Thermostat enabling the maximum and minimum internal cabinet temperature to be set within the range of 50 to 99 degrees F minimum. (The range may be greater than the range specified. Thermostat must prevent over cooling and provide for energy efficient operation. The thermostat is typically present at about 85 degrees F and cools about 10 degrees F before turning off);
- Utilize tamper resistant hardware. All exterior hardware shall be made of stainless steel.

- **Enclosure Electrical System**

Each enclosure shall include an electrical distribution system conforming to the requirements specified herein. Cabinet wiring shall conform to the requirements of Section 86-3.04C, "Cabinet Wiring" of the Caltrans Standard Specifications, unless otherwise specified herein. Equipment shall be labeled in conformance with 86-3.04D(1) "Labels" of the Standard Specifications.

Enclosures shall provide California Electrical Code (CEC) – compliant AC power distribution system.

- **Receptacles**

Each enclosure shall contain a minimum of 6 receptacles, two per bay. Each receptacle shall be a duplex, 3-prong, NEMA Type 5-15R grounding type outlet and shall conform to the requirements in UL Standard 943. Each receptacle circuit shall be protected by the surge suppression system.

- **Light Fixture**

Each bay shall include door-activated fluorescent overhead lighting.

- **Surge Suppression**

Every communications 3 Bay Communications Cabinet shall be equipped with Surge Suppression conforming to the requirements specified in Section 6.3.1.1 "Grounding and Surge Suppression" of this Design Criteria.

- **Circuit Breakers and Panelboard**

Enclosure compartment shall include utility AC power load center that includes 125 amps panelboard, with 125 amps main breaker and circuit breakers as shown on the plans. All circuit breakers shall conform to the provisions for circuit breakers in Caltrans Standard Specification Section 86-2.11, "Service", except that circuit breakers shall have a minimum interrupting capacity equal to or greater than the available fault current, and as otherwise modified herein. The Plans shall identify the required AIC rating for circuit breakers. Typically, a 42 kAIC is available at the service from SDG&E and shall be verified by the designer. A short circuit current analysis shall be done to determine the appropriate rating.

Circuit breakers shall be of an appropriate ampacity and contain the number of poles required for the connected loads. Circuit breaker to be used in new service panels and subpanels shall be molded case, quick-make quick-break bolt-on type, with thermal-magnetic type overload trip.

Circuit breakers to be used to modify existing panels shall be of a type similar to the existing breakers and match existing ratings.

- **Bonding and Grounding**

The enclosures shall include a grounding bar solidly connected to earth by connection to the communication grounding grid and the Station's grounding electrode system as shown on the Plans to tie all metal structures to a common earth ground with suitable conductors. All metal doors, panels and racks shall be bonded with grounding straps. No hinged or unlisted bolted connections will be considered a suitable path to ground.

Bonding and Grounding shall conform to the provisions in Section 86-2.10, "Bonding and Grounding," of the Caltrans Standard Specifications, the California Electric Code, and Section 6.3.1.1 "Grounding and Surge Suppression" of this Design Criteria. All enclosures and meter pedestals installed by the Contractor shall be grounded in conformance with the CEC requirements.

- **Uninterruptable Power Supply**

Every Communications Cabinet shall be equipped with an Uninterruptable Power Supply conforming to the requirements specified in Section 6.15 "Uninterruptable Power Supply" of this Design Criteria.

- **Enclosure Intruder and Over-temperature Sensor System**

The enclosure shall include a programmable logic controller conforming to the requirements specified in Section 6.3.1.2 "Programmable Logic Controller" of this Design Criteria with sensors to monitor intrusion, and high and shut down temperature thresholds.

Intrusion alarm device shall issue a notification once the door is opened by non-authorized personnel. Determination of an intruder versus authorized personnel may be determined by door limit switch, one on each door, and an operated by-pass switch mounted inside each section or entrance.

A high temperature alarm shall be sent to control when the internal temperature inside the enclosure reaches 90 degrees F. The system shall begin to shut down UPS and Digit recorders when the temperature reaches about 95 degrees F.

- **Rack Mounted Equipment**

Generally, all equipment and fiber optic and Category 6 termination panels, except surge suppression equipment, shall be installed in the equipment racks and the layout of the equipment should be consistent with equipment layouts used on the SANDAG Standard Plans.

- **Backboard Mounted Equipment**

All telephone service, public address, and TWC cable termination equipment and hardware, cable storage supports, PLC Accessory Enclosure, receptacles, and surge suppression equipment shall be mounted to the plywood backboard.

As new systems are added that provide enhanced or new capabilities these systems may require additional devices and equipment to be mounted to the backboard. To the greatest extent possible equipment should be mounted in the 19 inch racks, not on the backboard.

6.3.2.2 Communications Enclosure - Prefabricated Communications Building

The Prefabricated Communications Building shall conform to the following requirements.

- **Description**

The Prefabricated Communications Building shall be a transportable, bullet resistant, vandal resistant concrete equipment shelter capable of being shipped on a lowboy truck and placed utilizing a crane at each station site.

Each communications building shall set on a cast-in-place foundation will all necessary raceways entering through the foundation, through openings in the floor of the precast building, and stubbing up against the concrete wall.

Each communications building shall come complete with an electrical, surge suppression, and air condition systems described below.

The designer shall design the communications building for the explicit use of housing electronic equipment, fiber-optics equipment, measuring devices and other related components, within a controlled atmosphere required for the proper operating conditions for the equipment.

Except for sites with unique conditions, the designer shall incorporate SANDAG's standard prefabricated communications building plans and special provisions into the contract documents. The contract special provisions shall include complete material, equipment, installation specifications in the special provisions for all work required. The special provisions should be consistent with those used on past projects. The contract plans shall include the standard building floor plan, rack layouts, ceiling plan showing cable ladder, and elevations. The designer shall develop or modify electrical subpanel schedules, as needed, and shall include them in the contract plan set for each station.

At sites where unique conditions exist or additional equipment may need to be accommodated the standard prefabricated communications building shall be altered and the designer shall at a minimum submit the following design plans to the SANDAG and MTS systems engineers for review and approval:

- Floor plan showing: a) a minimum of 3 feet wide aisles in front of racks and plywood backboard; b) 3 feet wide aisle behind rack where feasible; c) sub panel(s) with minimum required NEC access clearances shown; d) 0.75-inch plywood with 1 foot of

space in front for equipment (not in aisle); e) transformer dimensions if required and located in communications room; and f) air conditioning unit(s) dimensions if located in communications room;

- Rack layouts showing equipment arrangements in each rack that are similar to the standard arrangements but in sufficient quantity to support the functionality of the station facility and includes a minimum of 20 percent empty spare rack space dedicated for future equipment expansion (all equipment shall be spaced with a minimum of 1 U in between to provide for adequate equipment ventilation and cable management);
- Cable ladder system hung from the ceiling over racks and plywood back board and connect to conduit penetrations;
- Electrical Subpanel Schedule(s) showing all connected loads with descriptions listing load assumptions;
- Air Conditioning Sizing Calculations in BTUs that accounts for: solar heat generation, equipment heat generation, and volume of air space.

- **Enclosure Finish and Capabilities**

The pre-assembled precast shelter shall be manufactured inside an enclosed plant building in a controlled environment. Unless otherwise determined by the project team, shelter shall have a desert tan exposed aggregate finish.

- **Enclosure Size**

The outside finish walls of the precast enclosure shall be a minimum of 11 feet 8 inches wide by 21 feet 8 inches long and 10 feet 1 inch tall.

- **Operating Environment**

The enclosure shall comply with the specified environmental operating ranges identified in Section 6.1.3 “Environmental”. Additionally, the enclosure shall be sealed to resist dust infiltration and be watertight.

Unless otherwise directed, the cooling and insulation systems shall be properly sized to maintain a temperature in the range of 75 to 85 degrees Fahrenheit. The design shall account for heat entering from outside the room, equipment operating heat output specified by the equipment manufacturer or estimated by the designer and shall not be less than the minimum Air Conditioning System and insulation values identified.

Enclosure shall be designed for the following:

- Floor – Shelter shall be designed to ASCE 7-88 Uniform Distributed Load of 250 psf.
- Roof – Shelter shall be designed ASCE 7-88 Uniform Distributed Load of 65 psf.
- Wind – Shelter shall be designed to ASCE 7-88 Basic Wind Speed Specifications of 115 MPH exposure C.
- Earthquake - Shelter shall be designed for ASCE 7-05 Seismic Design Category E.

- Durability - Shelter shall withstand 30-06 rifle fire at 15 feet distance per UL 752, Level 4 standard.
- Manufacturer shall submit a Quality Control Program for review. The Quality Control supervision shall be independent of manufacturing.

- **Submittals**

The designer shall require the contractor to submit the following:

- Detailed engineering and drawings provided for all features described in this section;
- Structural drawings stamped by a professional engineer registered in the State of California;
- Shop Drawings, detailed and dimensioned to indicate compliance with the Contract Drawings, these Specifications and field conditions, including the following items:
- Shelter manufacturer shall submit detailed drawing showing the concrete pad to support the shelter, with concrete pours, rebar layout and anchoring of the shelter to the pad;
- Shelter manufacturer shall submit a Quality Control Program for review. The Quality Control supervision shall be independent of manufacturing;
- Shelter manufacturer shall submit detailed conduit layout plan showing stub-up locations into the shelter;
- Manufacturer's literature and product data including: specifications, installation, and maintenance instructions and recommended practices; and
- Schedule delivery of Precast Concrete Equipment Shelter when slab, on which Precast Concrete Equipment Shelter will be permanently placed, is ready.

- **Concrete Specifications**

Compressive strength shall be 4000 PSI at 28 days.

Mix design shall be 114-118 pound per cubic feet structural lightweight concrete using expanded shale or expanded clay aggregate. Mix shall be homogeneous. Seeding of aggregates for exposed aggregate finish is not allowed.

Cement used in concrete shall be standard Portland cement conforming to the requirements of the "Standard Specifications for Portland Cement," ASTM C150.

Concrete aggregates shall conform to one of the following specifications:

- ASTM C33;
- ASTM C330.

Water shall be free from injurious quantities of oil, alkali, vegetable matter and salt. Non-potable water shall not be used in mixing concrete.

Reinforcement bars shall be deformed steel bars conforming to the requirements of ASTM A615.

Welded smooth wire fabric shall be steel wire fabric conforming to the requirements of ASTM A185.

Admixtures to be used in concrete shall be subject to prior approval by the quality control supervisor and shall be shown capable of maintaining essentially the same composition and performance throughout the work as the product used in establishing the concrete proportions in the mix design.

Air-entraining admixtures - conform to ASTM C260

Water reducing admixtures, retarding admixtures, accelerating admixtures, and water reducing and accelerating admixtures shall conform to ASTM C494.

Fly ash or other pozzolans used as admixtures shall conform to ASTM C618.

Compressive strength – 4,000 psi at 28 days.

Mix Design – 114 to 118 lb/ft³ structural lightweight concrete using expanded shale or expanded clay aggregate. Mix shall be homogeneous. Do not seed exposed aggregates for exposed finishes.

- **Sealing**

- Joints - Sealed with a compressible, resilient sealant. There shall be no exposed roof to wall or wall to floor joints.
- Exterior walls - Seal with two coats of a water-based ultraviolet (UV) light resistant semi-gloss acrylic concrete sealer (Thoroglaze H Sealer or approved equivalent) in strict conformance with manufacturer's instructions.
- Roof – Seal with two coats of white elastomeric coating.

- **Door**

- Frame – 16-gauge galvanized steel, primed, painted, and cast into the wall panel.
- Door – 3 feet by 7 feet by 1-3/4 inches 18-gauge galvanized steel, insulated, primed, painted brown and installed flush with door check, door stop, weather stripping, mortise lockset with changeable core, stainless steel ball bearing hinges and bullet resistant.

- **Telephone Service Provisions**

The designer shall show the installation of a conduit sized to phone company standards to be installed from designated phone company facility connection point to a point inside the enclosure in front of the plywood back board and be located within 3 feet (measured horizontally) of a wall mounted duplex outlet.

- **Electrical**

Electrical installation and wiring shall conform to the latest edition of the California Electrical Code and shall consist of the following as a minimum:

- Have electrical voltage and electromagnetic wave length (in Hertz) ratings that are compatible with and enable the unit to utilize power from the existing electrical service at each station without transformation thru other devises. The Designer shall conduct a field survey to determine proper sizing prior to designing the enclosure and station electrical service;
- Designer shall specify an electrical voltage and electromagnetic wave length (in hertz) ratings that are compatible with and enable the unit to utilize power from the existing electrical service at each station without transformation thru other devises. The Designer shall contact the Utility Company and conduct a field survey to determine proper sizing prior to developing the specification for the enclosure electrical subpanel and Air Conditioning System. Whenever possible, the Designer shall specify the AC unit with the highest voltage rating that matches the utility voltage available at the station site. In most cases, the new heat exchanger unit should have a voltage rating of 200 volts or higher;
- Entrance Conduit – Underground entrance conduit shall be Schedule 40 polyvinyl chloride (PVC) conduit;
- Interior Conduit - Interior Conduit shall be Underwriters Laboratories (UL) approved, surface mounted galvanized rigid steel (GRS) or electrical metallic tubing (EMT) conduit firmly mounted to the exterior surface using galvanized steel Unistrut connectors or an approved equivalent;
- Exterior Conduit – Exterior Conduit shall be UL approved, surface mounted galvanized rigid steel (GRS) conduit firmly mounted to the exterior surface using galvanized steel Unistrut connectors or an approved equivalent;
- Panelboard – The communications enclosure shall have an electrical subpanel with a current rating of at least 125 amps and a voltage that is based on available utility power in the area of the station. The subpanel shall be pre- wired for fluorescent lighting fixtures, wall switch, duplex outlets, and air conditioning units. The subpanel shall be fed from the Station’s electrical service panel and shall include at a minimum 12 single pole 20 amps breakers, one 30 amps double pole for the UPS, and additional breakers for the prefabricated buildings’ loads;
- Power wiring - Not smaller than No. 12, and enclosed in conduit. Fittings, wiring devices, and fixtures - UL-approved, and ready for site connection;
- Lighting – Shelter shall include a minimum of four fluorescent (two bulb) lighting fixtures (120 VAC) controlled by a light switch. Enclosure shall include an additional indoor light switch to control one outside lighting fixture (with built in photo cell unit) over the door’s entrance. The fluorescent fixtures, outdoor fixture and light switch and raceway shall be firmly mounted to the structure and include all wiring between the fixtures, light switches, and panel;

- A minimum of two of the light fixtures, one closest to the door and the other at the opposite end shall be dedicated emergency light fixtures. The fixtures shall be provided with battery backup;
 - Enclosure shall include illuminated exit light fixture over the door entrance, mounted to a surface mounted junction box. Provide raceway and wiring to the enclosure panel;
 - Enclosure shall include at least fourteen grounded duplex-grounded outlets (two per wall (one every 4 feet on the walls) and two over each 19 inch rack). Enclosure shall include raceway and wiring from the receptacles in a junction box to the Enclosure panel. There shall be two receptacle wall circuits, consisting of four receptacles to each circuit. Each outlet over each rack shall be on a separate circuit;
 - Enclosure shall include conduit and wiring from: a) the Air Conditioning (AC) Unit to the enclosure sub-panel; b) AC Unit to the thermostat control; and c) from the temperature probe to the programmable logic controller (PLC);
 - Design shall include monitoring of three phase utility services, raceways and wiring from the 3 phase power source to the phase loss relay, and monitoring wiring from the phase loss relay to the programmable logic controller (PLC);
- **Surge Suppression**

Every communications building shall be equipped with Surge Suppression conforming to the requirements specified in Section 6.3.1.1 “Grounding and Surge Suppression” of this Design Criteria.
 - **Bonding and Grounding**

The building shall include a ground grid, an internal halo grounding system and grounding bar solidly grounded to earth by connection to the communication grounding grid and the Station’s grounding Electrode System, mounted on standoff insulators as shown on the plans, to tie all metal structures to a common earth ground with suitable conductors. All metal doors, panels, and racks shall be bonded with grounding straps. No hinged or unlisted bolted connections will be considered a suitable path to ground.

Bonding and Grounding shall conform to the provisions in Section 86-2.10, “Bonding and Grounding,” of the Caltrans Standard Specifications, the California Electric Code, and Section 6.3.1.1 “Grounding and Surge Suppression” of this Design Criteria. All enclosures and meter pedestals installed by the Contractor shall be grounded in conformance with the CBC requirements.
 - **Uninterruptable Power Supply**

Every communications building shall be equipped with an Uninterruptable Power Supply conforming to the requirements specified in Section 6-15 “Uninterruptable Power Supply” of this Design Criteria.

- **Precast Enclosure Fabrication Requirements**

Structural design and manufacturing of precast enclosure shall conform to requirements of ACI 318-89.

- **Floor Section**

Surfaces of floors shall be smooth. Cover the interior surface with vinyl composition tile with rubber base molding, bonded with a waterproof contact adhesive.

- **Roof**

Roof shall be constructed of concrete with one percent drainage slope and completely covered with two coats of white elastomeric coating on the exterior face.

R11 ceiling insulation and finish to be foam-board insulation with 3/8 inches vinyl coated board. Install a plastic joint or corner trim at panel joints.

Roof section shall provide a 2-inch overhang on all sides. The roof will be a hip type sloping 4 directions. It shall be a cap and fit over the walls, leaving no exposed roof to wall joint.

- **Wall**

Each wall shall be 4 inches (102 mm) thick solid concrete, cast in one piece to minimize joints, with an exterior exposed aggregate finish.

R-11 wall insulation covered with 0.5 inches thick panel, surfaced with 0.03-inches fiberglass reinforced plastic (FRP). Plastic joint or corner trim shall be installed at all panel joints.

Floor/wall intersection shall be finished with 4-inches vinyl baseboard.

The walls shall overhang the floor a minimum of 7-inches from the top floor surface. There shall be no exposed wall to floor joint.

Thermal Insulation - Standard wall and ceiling thickness shall be covered with R-11 1-inch (25 mm) thick foam board insulation.

8 feet by 4 feet by 0.75 inches thick marine grade plywood securely fastened to wall with bolts over communications conduit entrances.

- **Lifting Attachments**

Building shall have cast in permanent lifting attachment points so that additional parts or bolt-on devices are not required for lifting the building.

- **Walkway**

Provide a concrete walkway completely around building. Slope walkway away from the structure.

- **Stairs**

Provide a concrete stairway leading to the building's doorway.

- **Enclosure Air Conditioning System**

Each communications enclosure shall have an Air Conditioning (AC) Unit, mounted on the side of it that shall be sized by the designer. Designer shall determine and develop technical specifications of the AC unit based on calculation of anticipated environmental and equipment heat generation values. The A/C units shall be generally consistent to those used on the existing system and conform to the following:

- Thermostat setting shall be no higher than 85 degrees;
- Shall have two AC units with penetrations to vent and cool the enclosure;
- Mount to enclosure shall have a rubber gasket or equivalent seal to create leak-proof seal between heat exchanger and communications enclosure;
- Have a 316 Stainless Steel enclosure Underwriters Laboratories, UL 50, NEMA 3R or greater rating for outdoor environments;
- Utilize CFC- Free Refrigerant;
- Suppress electromagnetic interference (EMI) and radio frequency interference (RFI);
- Whenever possible, the designer shall size the AC units with the highest voltage rating possible. In most cases, the new heat exchanger unit should have a voltage rating of 200 volts or higher;
- Be constructed of materials that protect against internal and external corrosion in salty, wet environments;
- Temperature Control Thermostat enabling the maximum and minimum internal cabinet temperature to be set within the range of 50 to 99° F minimum. The range may be greater than the range specified. Thermostat must prevent over cooling and provide for energy efficient operation;
- Utilize tamper resistant hardware. All exterior hardware shall be made of stainless steel.

- **Communications Racks**

Each enclosure shall be furnished with three (3) 19 inch four post free standing racks with 12-24 threaded standard holes spaced in conformance with CEA-310-E (EIA-310-D) and conforming to the site's seismic design requirements in the California Building Code and the requirements described in Telcordia Technologies Generic Requirements (GR) GR-63. Threading shall conform to the ANSI B1.1, Unified Course Thread (UNC) standard.

- **Communications Raceway**

Each enclosure shall be furnished with a complete continuous cable ladder system from the communications conduits entrance at the base of the sidewall, up the wall, and across the ceiling both along the front and along the back of the three 4 post 19 inch racks in accordance with the latest NEMA Standards Publication VE2. Wall mounted

ladder system shall be comprised of approximately 8 lineal feet of 18 inch wide aluminum cable tray. Ceiling mounted ladder system shall be comprised of approximately 86 lineal feet of 12 inches wide aluminum cable tray (open ladder type) with 6 inches rungs.

- **Enclosure Sensing System**

Building shall include a programmable logic controller conforming to the requirements specified in Section 6.3.1.2 “Programmable Logic Controller” of this Design Criteria, and an alarm controller with sensors to monitor intrusion, smoke, power failure, and high and shut down temperature thresholds. Intrusion alarm device shall issue a notification once the door is opened by non-authorized personnel. Determination of an intruder versus authorized personnel may be determine by either an electronic card reader access lock or a door limit switch and key operated by-pass switch mounted outside the building on the wall. Provide devices, raceways and wiring for a complete operating system back to a junction box. The two smoke detector alarms shall be mounted on opposite ends of the building. The detectors shall be mounted on their own individual surface mounted junction boxes. Sensors shall provide inputs and outputs to the PLC input/output (I/O) ports.

For enclosures powered by 3 phase services a phase loss relay shall be installed to monitor voltage powering the building. The relay shall be provided with two form “C” contacts and mounted into a NEMA 1 enclosure. Alarm indications of the phase loss relay shall be inputted into the PLC.

- **Rack Mounted Equipment**

Generally, all equipment and fiber optic and Category 6 termination panels, except surge suppression equipment, shall be installed in the equipment racks and the layout of the equipment should be consistent with equipment layouts used on the existing system.

- **Backboard Mounted Equipment**

All telephone service, public address, and TWC cable termination equipment and hardware, cable storage supports, and surge suppression equipment shall be mounted to the plywood backboard.

- **Field Quality Control and Testing**

Designer shall specify system performance and functional testing requirements to ensure that each completed Precast Concrete Equipment Building is tested to ensure operability of all electrical and communications systems, lamps, and air conditioning units in accordance with manufacturers’ printed instructions.

6.3.2.3 Communications Room

Communications Rooms may be used in Underground or Aerial Stations, Parking Structures, Buildings, and Transit Centers where space is limited or locating a standard enclosure is challenging do to site specific constraints or visibility concerns.

Communications Room shall be designed in accordance with applicable Uniform Building Code (UBC), National Electric Code (NEC), Institute of Electrical and Electronics Engineers

(IEEE), American Society of Civil Engineers (ASCE), and National Fire Protection Association (NFPA) and all federal and state recommended standards and requirements.

- **Floor Plans**

Communications Rooms supporting above surface stations shall be a minimum of 12 feet wide by 12 feet long by 10 feet tall.

Where site specific constraints limit the space available for the communications room, the designer may request approval from the SANDAG Project Manager and System Engineer to reduce the width to 8 feet. At locations where approval is granted, the 3 feet wide aisle behind the rack will be eliminated, however, a clear access space at least 3 feet wide on both sides of each rack with cable management shall be provided to enable workers to access the back of the equipment mounted in the standard 19 inch equipment racks this will require the length of the room to be lengthened to a minimum of 18 feet long. Every Standard 19 inch racks shall include vertical cable management on the sides of the rack.

Early in the design development process, the designer shall put together a complete floor plan that shows all rack locations, plywood backboard, and ensures all aisles are a minimum of 3 feet wide. The aisle shall be widened in front of electrical panels as needed to conform to California Electric Code (CEC) access requirements. All 19 inch racks shall be four post racks that are a minimum of 30 inches deep. Access isles shall be located in front and behind each 19 inch rack.

One wall shall be covered with a minimum of 32 squared feet of 0.75-inch plywood. A minimum of 18 inches in front of the backboard shall be provided so cable termination and related equipment can be mounted to the plywood backboard without intruding into the isles.

The design of the communications room shall be for the explicit use of housing electronic equipment, fiber-optics equipment, measuring devices and other related components, within a controlled atmosphere required for the proper operating conditions for the equipment.

The minimum width of a communications room shall not be less than 8 feet wide.

The designer shall at a minimum submit the following design plans to the SANDAG and MTS systems engineers for review and approval:

- Floor plan or enclosure(s) plan view showing: a) a minimum of 3 feet wide aisles in front of racks and plywood backboard; b) 3 feet wide aisle behind rack where feasible; c) sub panel(s) with minimum required CEC access clearances shown; d) 0.75 inch plywood with 1 foot of space in front for equipment (not in aisle); e) transformer dimensions if required and located in communications room; and e) air conditioning unit(s) dimensions if located in communications room;
- Rack layouts showing equipment arrangements in each rack that are similar to the standard arrangements but in sufficient quantity to support the functionality of the station facility and includes a minimum of 20 percent empty spare rack space

dedicated for future equipment expansion (all equipment shall be spaced with a minimum of 1 U in between to provide for adequate equipment ventilation and cable management);

- Cable ladder system in prefabricated buildings and rooms that are hung from the ceiling over racks and plywood back board and connect to conduit penetrations;
- Electrical Subpanel Schedule(s) showing all connected loads with descriptions listing load assumptions.
- Air Conditioning Sizing Calculations in BTUs that accounts for: solar heat generation, equipment heat generation, and volume of air space.

- **Operating Environment**

The room shall comply with the specified environmental operating ranges identified in Section 6.1.3 “Environmental”. Additionally, the room shall utilize positive air pressure and shall be sealed to resist dust infiltration and be watertight.

The cooling and insulation systems shall be properly sized to maintain a temperature in the range of 75 to 85 degrees Fahrenheit. The design shall account for heat entering from outside the room; equipment operating heat output specified by the equipment manufacturer or estimated by the designer and shall not be less than the minimum Air Conditioning System and insulation values identified.

- **Submittals**

The designer shall at a minimum submit the following design plans to the SANDAG and MTS systems engineers for review and approval:

- Floor plan showing:
 - A minimum of 3 feet wide aisles in front of racks and plywood backboard;
 - 3 feet wide aisle behind rack where feasible;
 - Sub panel(s) with minimum required CEC access clearances shown;
 - 0.75 inch plywood with 1 foot of space in front for equipment (not in aisle);
 - Transformer dimensions if required and located in communications room; and
 - Air conditioning unit(s) dimensions if located in communications room;
- Rack layouts showing equipment arrangements in each rack that are similar to the standard arrangements but in sufficient quantity to support the functionality of the station facility and includes a minimum of 20 percent empty spare rack space dedicated for future equipment expansion (all equipment shall be spaced with a minimum of 1 U in between to provide for adequate equipment ventilation and cable management);
- Cable ladder system in prefabricated buildings and rooms that are hung from the ceiling over racks and plywood back board and connect to conduit penetrations;
- Electrical Subpanel Schedule(s) showing all connected loads with descriptions listing load assumptions;

- Air Conditioning Sizing Calculations in BTUs that accounts for: solar heat generation, equipment heat generation, and volume of air space;
 - Designer shall submit detailed drawings showing all communications and electrical raceways connecting the Wide Area Network and Local Area Network Devices to the Communications Room. Drawings shall show stub-up locations into the room;
 - Designer shall require the contractor to submit manufacturer's literature and product data with specifications and installation instructions.
- **Door Guidelines**
 - Frame

The frame shall be 16-gauge galvanized steel, primed, painted, and cast into the wall panel.
 - Door

Doors shall be 3 feet by 7 feet by 1.75 inch 18-gauge galvanized steel, insulated, primed, painted and installed flush with door check, door stop, weather stripping, mortise lockset with changeable core, stainless steel ball bearing hinges and bullet resistant.
- **Telephone Service Provisions**

The designer shall show the installation of a conduit sized to phone company standards to be installed from designated phone company facility connection point to a point inside the enclosure in front of the plywood back board and be located within 3 feet (measured horizontally) of a wall mounted duplex outlet.
- **Electrical**

Electrical installation and wiring shall conform to the latest edition of the National Electrical Code and shall consist of the following as a minimum:

 - Have electrical voltage and electromagnetic wave length (in Hertz) ratings that are compatible with and enable the unit to utilize power from the existing electrical service at each station without transformation thru other devices. The Designer shall conduct a field survey to determine proper sizing prior to designing the enclosure and station electrical service.
 - Designer shall specify an electrical voltage and electromagnetic wave length (in hertz) ratings that are compatible with and enable the unit to utilize power from the existing electrical service at each station without transformation thru other devices. The Designer shall contact the Utility Company and conduct a field survey to determine proper sizing prior to developing the specification for the enclosure electrical subpanel and Air Conditioning System. Whenever possible, the Designer shall specify the AC unit with the highest voltage rating that matches the utility voltage available at the station site. In most cases, the new heat exchanger unit should have a voltage rating of 200 volts or higher.
 - Entrance Conduit – Underground entrance conduit shall be Schedule 40 polyvinyl chloride (PVC) conduit.

- Interior Conduit - Interior Conduit shall be Underwriters Laboratories (UL) approved, surface mounted galvanized rigid steel (GRS) or electrical metallic tubing (EMT) conduit firmly mounted to the exterior surface using galvanized steel Unistrut connectors or an approved equivalent.
- Exterior Conduit – Exterior Conduit shall be UL approved, surface mounted galvanized rigid steel (GRS) conduit firmly mounted to the exterior surface using galvanized steel Unistrut connectors or an approved equivalent.
- Communications Room shall have an electrical subpanel rated for at least 125A with a voltage that is based on available utility power in the area of the station. Subpanel breaker box shall include at a minimum 12 single pole 20 amp breakers, two 30 amp double pole for the UPS, and additional breakers for the AC system.
- Wiring - Internally wired for fluorescent lighting fixture, wall switch, duplex outlet, electric unit heater, air conditioning unit, and 125-amp, 12-circuit breaker 120/208 or 120/240 VAC, three-wire single phase panel board.
- Power wiring - Not smaller than American Wire Gauge (AWG) No. 12, and enclosed in conduit. Fittings, wiring devices, and fixtures - UL-approved, and ready for site connection.
- Lighting – Room shall include fluorescent (two bulb) lighting fixtures (120 VAC) controlled by a light switch over each aisle that provides evenly distributed light with a minimum of 3 foot-candles of lighting at the floor. The fluorescent fixtures, outdoor fixture and light switch and raceway shall be firmly mounted to the structure and include all wiring between the fixtures, light switches, and panel.
- At least two of the light fixtures, one closest to the door, another at the opposite end, and others evenly spaced between shall be dedicated emergency light fixtures. These fixtures shall have a dedicated emergency raceway and wiring.
- Room shall include illuminated exit light fixture over the door entrance, mounted to a surface mounted junction box. Provide raceway and wiring to the enclosure panel.
- Room shall include grounded duplex-grounded outlets spaced at 4 feet on center and two over each 19 inch rack. Room shall include raceway and wiring from the receptacles in a junction box to the communications room sub-panel(s) located in the communications room. Each outlet over each rack shall be on a separate circuit.
- Room shall have redundant air condition systems, uninterruptable power supplies and/or generators that will automatically start the backup unit. The room shall have its own Thermostat control. The programmable logic controller (PLC) shall send high temperature and over temperature alarms. The over temperature alarm shall initiate an organized shut down of the equipment.
- Design shall include monitoring of 3 phase utility services, raceways and wiring from the 3 phase power source to the phase loss relay, and monitoring wiring from the phase loss relay to the programmable logic controller (PLC).

- **Surge Suppression**

Every communications room shall be equipped with Surge Suppression conforming to the requirements specified in Section 6.3.1.1 “Grounding and Surge Suppression” of this Design Criteria.

- **Bonding and Grounding**

The room shall include a lightning arrester, a ground grid, an internal halo grounding system and grounding bar solidly grounded to earth mounted on standoff insulators as shown on the plans to tie all metal structures to a common earth ground with suitable conductors. All metal doors, panels, and racks shall be bonded with grounding straps. No hinged or bolted connections will be considered a suitable path to ground.

Bonding and grounding shall conform to the provisions in Section 86-2.10, “Bonding and Ground,” of the Caltrans Standard Specifications, the California Electric Code, and in Section 6.3.1.1 “Grounding and Surge Suppression” of this Design Criteria. All enclosures and meter pedestals installed by the Contractor shall be grounded in conformance with these Special Provisions.

- **Uninterruptable Power Supply**

Every communications room shall be equipped with an Uninterruptable Power Supply conforming to the requirements specified in Section 6.15 “Uninterruptable Power Supply” of this Design Criteria.

- **Minimum Finishing Requirements**

Structural design and manufacturing shall conform to applicable building and fire code requirements. The Communications room shall be completely sealed to prohibit the intrusion of water into the room.

- **Floor Section**

Surfaces shall be smooth. Cover the interior surface with vinyl composition tile with rubber base molding, bonded with a waterproof contact adhesive.

- **Roof**

R11 ceiling insulation and finish to be foam-board insulation with 3/8-inches vinyl coated board. Install a plastic joint or corner trim at panel joints.

Roof section shall provide a 2-inch overhang on all sides. The roof will be a hip type sloping 4 directions. It shall be a cap and fit over the walls, leaving no exposed roof to wall joint.

- **Wall**

R-11 wall insulation covered with ½-inch thick panel, surfaced with 0.03-inches fiberglass reinforced plastic (FRP). Plastic joint or corner trim shall be installed at all panel joints.

Floor/wall intersection shall be finished with 4-inches vinyl baseboard.

The walls shall overhang the floor a minimum of 7 inches from the top floor surface. There shall be no exposed wall to floor joint.

Thermal Insulation - Standard wall and ceiling thickness shall be covered with R-11 1-inch (25 mm) thick foam board insulation, unless another equivalent means of insulation is provided.

8 feet by 4 feet by 0.75 inches thick marine grade plywood securely fastened to wall with bolts over communications conduit entrances.

- **Enclosure Air Conditioning System**

Each communications room shall have primary and back up Air Conditioning (AC) system that provides sufficient cooling to control the temperature of the room to within specified limits that shall be sized by the designer. Designer shall determine and develop technical specifications of the AC unit based on calculation of anticipated environmental and equipment heat generation values. The A/C units shall be generally consistent to those used on the existing system and conform to the following as described below.

Each communications room shall have a primary and back up Air Conditioning (AC) system that provides sufficient cooling to control the temperature of the room to within specified limits. At a minimum the each redundant cooling system shall have a minimum capacity of 36,000 BTU per hour with proper ducting to properly vent and cool the room. Air conditioning system shall utilize CFC- Free Refrigerant and suppress electromagnetic interference (EMI) and radio frequency interference (RFI). Whenever possible, the designer shall size the AC units with the highest voltage rating possible. In most cases, the new air conditioner unit should have a voltage rating of 200 volts or higher. Temperature Control Thermostat enabling the maximum and minimum internal communications room temperature to be set within the range of 50 to 99 degrees F minimum. Thermostat must prevent over-heating, over-cooling, and provide for energy efficient operation.

- **Communications Racks**

Each enclosure shall be furnished with a minimum of three (3) 19 inch four post free standing racks with 12-24 threaded standard holes spaced in conformance with CEA-310-E (EIA-310-D) and conforming to the site's seismic design requirements in the California Building Code and the requirements described in Telcordia Technologies Generic Requirements (GR) GR-63. Threading shall conform to the ANSI B1.1, Unified Course Thread (UNC) standard.

- **Communications Raceway**

Each enclosure shall be furnished with a complete continuous cable ladder system from the communications conduits entrance at the sidewall, up the wall, and across the ceiling both along the front and along the back of the three 4 post 19 inch racks in accordance with the latest NEMA Standards Publication VE2. Wall mounted ladder system shall be comprised of approximately 8 lineal feet of 18 inches wide aluminum cable tray. Ceiling mounted ladder system shall be comprised of approximately 86 lineal feet of 12 inches wide aluminum cable tray (open ladder type) with 6 inches rungs.

- **Enclosure Sensoring System**

Room shall include a programmable logic controller conforming to the requirements specified in Section 6.3.1.2 “Programmable Logic Controller” of this Design Criteria, and an alarm controller with sensors to monitor intrusion, smoke, power failure, and high and shut down temperature thresholds. Intrusion alarm device shall issue a notification once the door is opened by non-authorized personnel. Determination of an intruder versus authorized personnel may be determined by either an electronic card reader access lock or a door limit switch and key operated by-pass switch mounted outside the room on the wall. Provide devices, raceways and wiring for a complete operating system back to a junction box. The two smoke detector alarms shall be mounted on opposite ends of the room. The detectors shall be mounted on their own individual surface mounted junction boxes. Sensors shall provide inputs and outputs to the PLC input/output (I/O) ports.

For enclosures powered by 3 phase services a phase loss relay shall be installed to monitor voltage powering the room. The relay shall be provided with two form “C” contacts and mounted into a NEMA 1 enclosure. Alarm indications of the phase loss relay shall be inputted into the PLC.

- **Rack Mounted Equipment**

Generally, all equipment and fiber optic and Category 6 termination panels, except surge suppression equipment, shall be installed in the equipment racks and the layout of the equipment should be consistent with equipment layouts used on the existing system.

- **Backboard Mounted Equipment**

All telephone service, public address, and TWC cable termination equipment and hardware, cable storage supports, and surge suppression equipment shall be mounted to the plywood backboard.

- **Field Quality Control and Testing**

Designer shall specify system performance and functional testing requirements to ensure that each completed Communications Room is tested to ensure operability of all electrical and communications systems, lamps, and air conditioning units in accordance with manufacturers’ printed instructions.

6.3.3 Communications Enclosures at Enclosed or Non-Standard Stations

A station containing more than two platforms or is enclosed in a structure (i.e. a station in a tunnel) shall have communications enclosure (cabinet, precast concrete building, or communications room) that adequately sized to accommodate the equipment required to support the station facility and are generally consistent with the communications facility layouts used at a standard two platform unenclosed station.

6.4 Wide Area Network Communications

6.4.1 Network Architecture

The MTS Network is composed of two paralleling single mode fiber optic networks; one vital and one non-vital.

Designers shall develop contract plans and special provisions that are consistent with current design practices utilized on the existing system.

6.4.1.1 Vital Wide Area Network

The Vital Wide Area Network (WAN) is essential to the safe and efficient operation of the light rail system and is physically separated from the Non-Vital WAN. The Vital WAN is a redundant network solely used by the Railway Signaling System and is generally referred to as the “Vital Railway Signaling Network”. The Vital WAN is comprised of a series of nodes located within Railway Signaling cabinets connected together via a dedicated 24 strand single mode fiber optic cable forming a series of redundant rings. The Vital Railway Signaling Network is used to carry vital data between locations. The Vital signaling system is a Safety Critical system designed in conformance with the “fail-safe principles and practices” described in Part 16 of the American Railway Engineering and Maintenance-of-Way Association (AREMA) Communications & Signals Manual of Recommended Practices.

At locations where the 24 strand fiber optic cable runs over head or past a signal cabinet a 12, 24, or 48 strand single mode fiber optic riser cable with an aerial splice closure shall be used to connect into the 24 strand cable. The Vital WAN connects all signal programmable logic controllers (PLC) in each signal cabinet to each other and with the Maintenance of Way offices.

The Vital WAN shall not be accessible from the internet or another outside network. It shall remain physically isolated from all other networks.

At each Automatic Interlocking the railway signaling system PLC’s non-vital communications module also connects via the Non-Vital LAN and WAN switches at the nearest station to form a link between the Operations Control Center and railway signaling system to carry signaling system SCADA information back and forth. The Signaling System SCADA data shall include, but not be limited to: the wayside signaling system sharing track circuit occupancy, signaling system indication, and unlock light information and the OCC to be submit remote route and cancelation requests to the wayside signaling system at the railway signaling system interlockings.

All Vital WAN connections shall utilize TCP/IP and Genesis protocols, conform to MTS Vital WAN IP address standards; and remain consistent with existing MTS bid addressing methods currently utilized on the system. See the Railway Signaling and Indications Systems section for additional information regarding the Non-Vital WAN interfaces to the Vital railway signaling system PLCs.

All Vital WAN splicing diagrams shall be developed in close cooperation with the Railway Signaling System Designers and the SANDAG systems engineers. Often the SANDAG system engineers will develop the Vital WAN splicing diagrams and provide them for inclusion in the designers plan set.

6.4.1.2 Non-Vital WAN

The non-vital WAN, like the Vital WAN, is essential to the efficient operation of the MTS system and is typically referred to as the MTS “Wide Area Network (WAN)”. It shall be designed to provide a second uniquely routed independent redundant path that ensures if the primary path is severed the system will automatically switch over to the secondary path.

The Wide Area Network (WAN) serves as the core network that enables communication between the Operations Control Center and each trolley station. The WAN is a Resilient Packet Ring (RPR) all dielectric single-mode fiber (SMF) optical network and utilize Enhanced Interior Gateway Routing Protocol (EIGRP) for each Segmented Packet Ring (SPR). The RPR network protocol shall conform to IEEE 802.17 standards, unless otherwise specified herein. The WAN RPR switch over protection rate may be reduced to 250 ms.

All LAN network communications shall be 10/100 Base T TCP/IP Ethernet communications utilizing 12 bit IP Addresses. The Wide Area Network shall be so designed to also enable 1000 Base-T gigabits of data transmission with 16 bit IP Address to provide for future high bandwidth capacity.

The designer early in the WAN design development process shall submit a conceptual fiber optic network topology design showing network hubs, nodes, and connections to the SANDAG systems engineering team for review and acceptance. In addition the designer shall also submit the proposed RPR configuration that identifies RPR limits to the SANDAG systems engineering team for review and acceptance.

The WAN nodes shall be located in the communications enclosure at the trolley station, unless otherwise approved by the SANDAG systems engineer on a site by site basis. Some trolley stations may also serve as WAN hubs.

6.4.2 WAN SMF Cabling

The WAN SMF cable shall be an all dielectric 144 strand single-mode fiber (SMF) optical cable conforming to the requirements of ICEA S-87-640 “Standards for Optical Fiber Outside Plant Communications Cable”. The cable shall be designed shall contain 12 buffer tubes each with 12 single mode fiber optical strands. Cables shall be designed to endure the rigors of installation while maintaining excellent attenuation performance and must provide protection against ultraviolet (UV) radiation, water penetration and gnawing rodents. Color coding of buffer tubes and fiber strands shall conform to TIA/EIA-598-C Optical Fiber Cabling Color Coding standards for easy identification per EIA 359-A. .

Stations may be connected to the 144 strand SMF local distribution cables and shall be use a 12, 24, or 48strands SMF cable conforming to the same standards and requirements described for the 144 strand SMF cable.

Each strand in each SMF cable shall be designed and factory tested to ensure the following frequencies are transmitted with excellent attenuation and bandwidth performance: 1,310 nm, 1,383 nm, and 1,550 nm in conformance with ISO/IEC 24702 and ITU-T G.652.D standards.

All fiber optic cable splices shall be made using fusion splices. All cable terminations shall be made using subscriber connectors (SC). SC fiber termination connectors shall be fused to the WAN SMF cable to terminate it to the fiber distribution unit in each communications enclosure or communications room.

SC SMF patch cords shall be used to connect the WAN switch to the fiber distribution unit.

Fiber cabling plans should avoid placing fiber optic splice closures in subsurface vaults whenever practicable.

All cables shall be tagged in accordance with the requirements described below in Section 6.5.4 “Cable Tags”.

Dedicated fiber optic strands within the 144 strand SMF cable shall be allocated to form a Fire Alarm Control and Emergency Management System (FACEMS) solely dedicated to link Intelligent Fire Alarm Control Panels (FACP) at elevated stations and Emergency Management Panels (EMP) at underground stations to the existing Simplex Grinnell Incident Commander (IC) located in the Operation Control Center. The dedicated Fire Alarm Management System fiber optic strands shall form a redundant ring connecting all of the panels to each other and linking them with the OCC. The designer shall meet with SANDAG and MTS to obtain information about the existing dedicated fiber connections and determine how to connect in the additional FACP located along a new line segment or to link up an existing station that is being upgraded with new Simplex Grinnell compatible Intelligent Fire Alarm Control Panels.

The Communications Systems designer shall work with the stations fire life safety designer, SANDAG, and MTS staff to develop system interface details. Fiber strand allocation, splicing and termination drawings shall identify the fiber strands dedicated to the FACEMS. The communications system designer shall refer to sections 2.9 “Fire Protection System” and 2.10 “Fire/Life Safety (Elevated or Underground Station)” for additional information regarding the Fire Life Safety System.

6.4.3 WAN Modifications and Equipment Procurement and Installation

When there are plans to expand or modify the Wide Area Network management system, the designer shall work cooperatively with MTS and SANDAG staff to determine the existing system configuration. The designer shall perform evaluation of the existing system to determine if it is sufficient to handle additions and/or newer technologies proposed. Any necessitated modifications to the system shall be submitted to the SANDAG systems engineer for review. Modifications to the existing system shall be compatible with associated systems and upgradable as the LRT system expands.

The designer shall ensure that the network management system maintains its objective including:

- **Operations:** Keeping the network (and the services that the network provides) up and running smoothly. Including monitoring the network to spot problems as soon as possible, ideally before users will be affected;
- **Administration:** Keeping track of resources in the network and how they are assigned. Including all the "housekeeping" that is necessary to keep the network under control;
- **Maintenance:** Allowance for continued performance of repairs and upgrades;
- **Provisioning:** Allowing continued configuring of resources in the network to support a given service.

Often WAN switches and power supplies are procured under separate contract and installed as owner furnished material; the designer shall meet with the SANDAG project manager and systems engineer to determine if the WAN modifications shall be included in the contract

documents. If there is determination that the new equipment and network management system changes be included, then the designer shall develop complete contract plans and Special Provisions detailing all necessary changes and installation requirements that will ensure minimal impacts to the operation of the existing network. Substantive changes to the network requiring shut downs of the network shall be required to be performed during the least impacted periods, or during non-revenue window period.

6.4.4 WAN Design

Designers shall develop contract plans and special provisions that are consistent with current design practices utilized on the existing system.

6.5 Local Area Network Communications

6.5.1 Network Architecture

The Local Area Network (LAN) shall utilize a hub and spoke architecture. The LAN Cisco 48 port 3560 series layer 3 network switch shall be connected to the WAN Cisco 15454 series network switch via a multi-mode fiber connection patch cord. The LAN shall be comprised of a 48 port network switch. All network devices shall connect to the 48 port switch, except that the video surveillance system shall have only a single point of connection to the WAN Switch. All of the following devices shall connect directly to the 48 port network switch utilizing a standard RJ-45 connector, unless otherwise directed: Passenger Card Interface Device (PCID) (also known as, “smart card reader”), Ticket Vending Machine (TVM), Public Address Digital to Analog Converter, Variable Message Signs (VMS), Signaling System SCADA, UPS’s, PLC, Traction Power System SCADA, and other network devices needed for future functionality. Devices located over 300 feet in cable length from the Communications Cabinet shall be connected to the LAN switch via a LAN Single Mode Fiber Optic cable.

6.5.2 LAN Ethernet Cables

Devices located less than 300 feet in cable length from the Communications Cabinet shall be connected to the LAN switch via a LAN Ethernet Cable using CAT6 cable. The LAN Ethernet cables shall be outdoor rated ANSI/TIA Category 6 unshielded twisted pair (UTP) cable containing 4 twisted pairs and conforming to the requirements of ANSI/TIA-568-C.2 and ISO/IEC 11801 Class E. All LAN Ethernet cables from field devices shall be terminated to a rack mounted Category 6 patch panel to configure the circuits for the “straight through” configuration in accordance with T568 A or T568 B standards, patch cords shall be used to make the connection between the Category 6 patch panel and the 48 port LAN switch. All cables within the communications cable shall be properly labeled and neatly trained. All cables shall be tagged in accordance with the requirements described below in “Cable Tags”.

Following installation all LAN Ethernet cables, cables shall be tested and certified that the cables conform to the TIA-568-B industry standards using a TIA certified Category 6 cable tester.

6.5.3 LAN SMF Cabling

The LAN optical fiber cables shall be all dielectric 12, 24, and 48 strand single-mode fiber optical cable conforming to the requirements of ICEA S-87-640 “Standards for Optical Fiber Outside Plant Communications Cable” shall be designed contain 12 buffer tubes each with

12 single mode fiber optical strands. Cables shall be designed to endure the rigors of installation while maintaining excellent attenuation performance and must provide protection against ultraviolet (UV) radiation and gnawing rodents. Color coding of buffer tubes and fiber strands shall conform to TIA/EIA-598 Optical Fiber Cabling Color Coding standards.

LAN devices located between stations (e.g. traction power and railway signaling SCADA systems) shall be connected to the station via available strands in the WAN 144 strand SMF cable using a 12-, 24-, or 48-strand SMF riser cables conforming to the same standards and requirements described for the 144 strand SMF cable. The riser cables shall be spliced into the 144 strand SMF cable at locations near the field devices locations via an aerial splice closure mounted to the 3/8-inch EHS cable support messenger wire. Designers should avoid installing splice closures in handholes or cable trays. Typically, cables can be run into and out of the enclosure without the need for a splice closure. At locations where special conditions exist and a splice closure must be located in a pull box, vault, manhole, the pull box or vault shall be an SDG&E standard 3313 handhole or Caltrans standard fiber optic manhole.

Each strand in each SMF cable shall be designed and factory tested to ensure the following frequencies are transmitted with excellent attenuation performance: 1,310 nm, 1,383 nm, 1,550 nm in conformance with ISO/IEC 24702 and ITU-T G.652.D standards.

All fiber optic cable splices shall be made using fusion splices. All cable terminations shall be made using subscriber connectors (SC). SC fiber termination connectors shall be fused to the WAN SMF cable to terminate it to the fiber distribution unit in each communications enclosure or communications room.

6.5.4 Cable Tags

All communications cables shall be labeled with cable tags conforming to the following requirements:

- Each end of every patch cord, fiber optic cable, UTP cable, and speaker cable shall be labeled with Allied Electric Self-Laminating Laser Tag labels (Manufacturer's number TAG5L-105) or an approved equivalent;
- Each label shall contain the end device name (e.g. "VMS-SB1," "TWC-SB1," etc.), the near end termination port identification (e.g. "ES-C3" (Gigabit Ethernet Switch, port C3)) and the far end termination port identification at the other end of the cable (e.g., "16MC-1" (16 Bay Media Converter, port 1). Contractor shall submit proposed device naming convention and port identification naming conventions for approval;
- Tagging formats and administrative records shall be maintained for all cables. Tagging formats and administrative records shall be created following an approach that is similar to EIA/TIA-606 standard practices. Nomenclature shall be consistent with naming conventions shown on the plans. Labels shall be concise and preferably diagrammatic in form. All labels or number plates and warning notices shall have black lettering on a white background. The size of the letters and the nature of the wording shall be submitted by Contractor. All conductor wires and cables shall be identified whenever they enter or leave a junction box, manhole, housing, or enclosure, and at all terminals;

- All labels, number plates and warning notices shall be of durable and corrosion resistant materials securely fitted by permanent means and clearly worded. For outdoor use they shall remain legible and not suffer degradation throughout the expected life of the equipment. All wires and cables shall be tagged during the termination process, as specified herein;
- Permanent non-conducting marking tags fastened securely to the wires and cables shall be used for identification. Wire designations shall consistently conform to an overall scheme prepared by SANDAG. The Contractor shall develop detailed labeling and administrative records that indicate location, circuit, device, wire number, terminal branch, and position, etc. Letters and numbers shall be used.
- Every signal cable jacket shall be labeled with permanent William Frick and Company 7" x 8" SnapAround™ PVC cable tags, or acceptable equivalent, at both ends and in every pull boxes with the circuit nomenclature (as shown on the Contract Drawings or approved shop drawing) and the "location" or "terminal" designation information clearly identified in permanent UV resistant ink and covered with clear polyester overlay protectant sheets.

6.5.5 LAN Design

Designers shall develop contract plans and special provisions that are consistent with current design practices utilized on the existing system.

6.6 Cabling Raceways and Access Points

6.6.1 Cabling Raceways Paralleling the Trackway Except Under Stations

Generally, a single combined aerial raceways comprised of insulated railroad signaling and fiber optic cabling double lashed to a 3/8 extra high strength (EHS) galvanized steel strand cable firmly attached to catenary poles shall be used along the trackway, except where one of the following conditions are met:

- Connections between equipment enclosures (e.g. traction power substations, railway signaling cabinets and houses, and communications cabinets, houses, and rooms) and riser poles;
- Transitions from riser poles located between or on the opposite side of the tracks to a riser pole located on the near side of the tracks;
- Between riser poles located just outside each end of a trolley station;
- Aerial structures, not less than 500 feet in length, enabling cable trays to be placed on the bridge deck in areas that would not adversely affect the use of emergency egress paths;
- Transition areas from bridge deck cable trays to riser poles; and
- Scenic areas identified during the environmental review process as requiring aerial cabling visual impact mitigation.

All aerial signal 3/8 inch EHS galvanized steel strand termination poles shall have standard downguy assemblies attached to the opposite side of the poles and attaching to standard

downguy foundations or embedded anchors in retaining wall or bridge structures. To improve the cost effectiveness of the installation designers should try and utilize downguy foundations required for other systems like the catenary termination and mid-point anchor pole locations where feasible. In some cases this may require additional 3/8 inches EHS guy strand to be run past the riser pole to a location further down the line or to trench conduit an additional span to make use of a riser pole located slightly further away.

The railway signaling, communications system, and overhead contact system (OCS) designers shall work together to identify riser pole locations and ensure all provisions for additional downguy foundations and anchors are shown on the OCS layout design plans.

The combined raceway shall contain vital railway signal (fiber optic and multiconductor copper), railway signaling power distribution, and 144-strand single mode WAN/LAN fiber optic cables.

The construction of cable raceways shall be constructed of materials and configurations commonly used on the existing system and conforming to the requirements described below in the sections labelled “Access points” and “Raceway Materials” of this Design Criteria.

6.6.1.1 Riser Pole Raceways

Generally, multiconductor railway signaling cabling for new installations shall utilize surface mounted exposed conduit up to a pole mounted stainless steel junction box mounted to the face of the new steel catenary pole with second reinforced pole penetration and then run inside the pole to pole spouts. Multiconductor railway signaling cables shall be landed in a pole mounted stainless steel junction box containing standard AAR railway signaling terminals. Junction boxes shall be firmly attached to the catenary pole utilizing spreader brackets.

Where new catenary poles will be installed fiber optic cabling shall be run through inner duct up through the catenary pole foundation into and up through the pole and out of the pole through pole spouts.

Where new catenary poles shall be used as railway signaling and/or as a fiber optic cable system riser pole, the designer of those systems shall provide riser pole information to the Overhead Contact System (OCS) designer to ensure design plans show the installation of catenary pole foundations with all necessary conduit and new catenary poles with all necessary reinforced penetrations and pole spouts.

At locations where existing catenary poles will be converted into riser poles the cables shall be run through exposed surface mounted conduit. Conduit banded to the pole shall conform to the requirements described below for “Exposed Conduit in Coastal Areas” or “Exposed Conduit in Inland Areas” as applicable.

6.6.1.2 Cable Tray Raceways

Cable Tray Raceways shall be used on bridge structures greater than 500 feet in length. Cable trays shall have removable lids and be similar to those used on the existing system. All cable trays shall be constructed of hot dipped galvanized steel conforming to the requirements of section 75, “Miscellaneous Metal” and 75-1.05 “Galvanizing” of the Caltrans Standard Specifications.

6.6.1.3 Underground Conduit Raceways

Generally underground Type 3 Schedule 40 PVC conduit raceways conforming to the requirements described below in “Buried Subsurface Conduit” shall be used to make connections between riser poles, equipment enclosures, and cable trays. All buried subsurface conduits shall be sized to provide for a maximum fill ratio of 20 percent fill. Vital and Non-vital raceways paralleling the trackway shall be comprised of a minimum of two 4 inches Schedule 40 PVC conduits.

All communications and power pull boxes should be of sufficient size to allow for cable and wiring to be pulled back from stub-ups and stored. Conduits entering pull boxes shall be permanently identified as to destination using metal tags.

6.6.1.4 Railway Signaling Communications and Power Cabling Through Stations

Vital railway signaling power distribution and communications cabling through stations shall be run under station platforms through a minimum of two 4 inch conduits extending from riser pole, cable tray, or to railway signaling system enclosures located outside of the station to riser pole, cable tray, or to railway signaling system enclosures on the opposite side of the station. If the distance from the end of the platform to the riser pole, cable tray, or signaling system enclosure is greater than 50 feet, then additional traffic rated “MTS Railway Signaling” pull boxes conforming to the requirements described in below in the section labelled “Access Points” shall be added at approximately 15 feet off the end of the station platform. Through stations the railway signaling system cables should not be mixed with non-vital communications and non-vital electrical power cabling.

6.6.1.5 Station Non-vital WAN and LAN Raceway System

The station non-vital WAN and LAN raceway system shall be comprised of two main raceway systems: a) Raceway Systems Under At-grade Station Platform Areas, b) Platform Raceways in Structures, and c) Raceways in Parking Lots and other non-platform areas.

- **Raceway Systems Under At-grade Station Platform Areas**

Raceways under station platform areas shall be comprised of three sets of traffic rated electrical and communications pull boxes per platform. Each set of pull boxes shall be comprised of a traffic rated communications pull box/ handhole and a traffic rated electrical pull box/ handhole conforming to the requirements described below in the section labelled “Access points” of this Design Criteria.

At a minimum, one set of the pull boxes shall be located in the middle of the station and the other two sets shall be located just beyond opposite ends of each platform. Pull boxes shall be set flush with the finish platforms.

Three 3-inch communications and power conduits shall be run between adjacent communications and power pull boxes under each platform and perpendicular to the tracks (3 under track crossings) and shall contain all communications system cabling. An additional set of three 3-inch conduits Schedule 40 PVC communications conduits shall be included to the Communications System conduit runs.

Three 3-inch electrical conduits shall be run between adjacent electrical pull boxes under each platform and perpendicular to the tracks (three under track crossings) and shall contain all electrical system cabling.

Two 1-inch branch conduits (one for electrical and one for communications) shall connect the nearest set of pullboxes/ handholes to each device (e.g. light poles for PA speakers and cameras, VMS sign frames or mounting locations for VMS sign and cameras).

Each PCID and TVM shall have two 1-inch conduits (one for electrical and one for communications) connecting it to the nearest set of pullboxes/ handholes. Both conduits shall have threaded PVC couplings on the ends and the tops set flush with the finished surface. Threaded plugs shall be screwed into the couplings.

- **Station Platform Raceway Systems in Structures**

Raceways in structures shall conform to the same arrangement as utilized for stations at grade, however, the designer may require surfacemounted conduit to be installed within the cells of the bridge provided the cell of the bridge is accessible through a hinged access door that is lockable with a standard pad lock to prevent entry. Pull boxes may be located within the bridges provided they are permanently accessible in accordance with NEC requirements.

- **Bus Transit Platforms**

Two 1-inch conduits (one for electrical and one for communications) shall run from the nearest set of pullboxes/ handholes to each device (e.g. light poles for cameras, VMS sign frames for bus information signage).

- **Raceways in Parking Lots, and Other Non-Platform Areas**

Two 1-inch conduits (one for electrical and one for communications) shall run from the nearest set of pullboxes/ handholes to each device (e.g. light poles for cameras, smart bicycle lockers). Both conduits shall have threaded PVC couplings on the ends and the tops set flush with the finished surface. Threaded plugs shall be screwed into the couplings.

Three 3-inch PVC conduits shall be run to pairs of communications and electrical pull boxes positioned throughout the site to facilitate the installation for future systems and provide for the co-mingling of the communication and electrical circuits in the parking lots and non-platform areas.

Designated parking spots shall have electrical and communications conduits installed for recharging stations.

If solar power generation facilities are incorporated into the station parking lot electrical design, then a minimum of two 1 inch communications conduit shall be provided for an Ethernet SCADA connection.

- **Raceways in Parking Structures**

Parking structures shall have conduit raceways for the following systems at a minimum:

- Smart Parking (1-inch electrical and communications to every parking space);
- Top layer solar electrical power generation (1-inch conduit to communications to inverter and DC disconnect switch locations, electrical sized as needed);
- Video Surveillance system (1-inch for power, 1-inch for communications);
- Variable messaging signage systems (1-inch for power, 1-inch for communications).

Parking structures shall be equipped with sufficient conduit to provide for Video Surveillance near the center of every isle and in every light pole on the roof top. If solar electrical power generation systems are included, the video surveillance cameras may be able to be mounted to the support frame structure.

Every elevator shall have electrical and communications conduit connecting it to the station communications enclosure or room for video surveillance cameras mounted in the elevator.

Electrical and communications for fire life safety systems as required by NFPA and NEC requirements.

6.6.2 Raceway Materials and Installation

All conduits shall be UL or ETL listed. All installation work shall conform to the requirements specified in section 86-2.05b “use” and section 86-2.05c, “installation” of the Caltrans standard specifications, unless otherwise specified herein.

- **Buried Subsurface Conduit**

All buried conduit shall be Caltrans Type 3, Schedule 40 polyvinyl chloride (PVC) rigid non-metallic conduit conforming to the requirements in the UL standard for rigid non-metallic conduit (Publication UL 651). Conduit to be placed under existing pavements shall be installed using the “trenched in pavement method” unless otherwise approved or directed.

Contractor shall have Underground Service Alert (USA) mark out all existing utilities and retain an experienced underground facilities locating company to locate and mark out the existing MTS facilities. USA can be reached at 1-800-227-2600.

All buried conduit shall be installed a minimum of 24 inches below the finished surface in paved areas, 30 inches below the finished surface in unpaved areas, and 36 inches below bottom of railroad ties.

Conduit shall be bored or jacked under the trackbed at the locations shown on the plans. Dig boring pits a minimum of ten feet from existing tracks, unless otherwise approved by the Engineer. Design and submit all shoring plans as needed to install conduit system.

All trenching for conduit installation shall conform to requirements specified in Section 86-2.02, “Removing and Replacing Improvements” of the Caltrans Standard Specifications, unless otherwise directed or approved by the SANDAG project manager or systems engineer on a site by site basis. Trench backfill shall be compacted to 95 percent minimum compaction as specified in section 86-2.01 “Excavation and Backfilling” of the Caltrans Standard Specifications.

A detectable warning tape shall be installed be provided and placed in the trench over all new conduits. The warning tape shall be 100mm wide with bold printed black letters of approximately 19 mm on bright orange color background, and contain a printed warning, repeated at approximately 800 mm intervals. The printed warning shall be non-erasable, shall be rated to last with the tape for a minimum of 40 years, and shall identify the applicable buried system such as “Caution Fiber Optic Buried Below”, “Caution Buried Electric Line Below”, or “Caution Communication Cable Buried Below”.

The construction of the warning tape shall be such that it will not delaminate when it is wet. It shall be resistant to insects, acid, alkaline and other corrosive elements in the soil. It shall have a minimum of 712 N tensile strength power 150 mm wide strip and shall have minimum of 700 percent elongation before breakage.

Use sweeps with a minimum bend radius of 16 inches, whenever physically possible.

After cables are pulled, all ducts shall be sealed with an approved sealant. All conduits shall be completely sealed to prevent intrusion of foreign objects and creatures.

When any facilities are placed below grade, a detailed conduit, cable, and facilities plan shall be submitted to the Engineer for approval.

- **Exposed Conduit in Coastal Areas**

All exposed surface mounted conduit located within 5 miles of the nearest salt water body of water shall be considered to be coastal and conform to the requirements described in this section.

All exposed conduit shall be Caltrans Type 1, hot-dip galvanized rigid steel conduit conforming to the requirements in UL Publication UL6 for Rigid Metallic Conduit or Type 3. The zinc coating shall be capable of passing a test performed in conformance with ASTM Designation: A239.

All surface mounted conduits attached to catenary poles shall be banded to the poles with Type 316 stainless steel banding spaced at not greater than 5 feet apart.

All surface mounted and I-beam supported conduit, except conduit to be attached to catenary poles, shall be attached to the surface with hot dipped galvanized steel or Type 316 stainless steel framing channels and all associated fittings and hardware including, but not limited to, clamps, brackets, hanger rods, and fittings.

All hardware shall be made of Type 316 stainless steel.

Channels shall be secured to concrete surfaces, other than catenary poles, with type 316 stainless steel mechanical wedge anchor fasteners that firmly anchor the channel to the surface in conformance with the manufacturers recommended installation procedures. The anchors shall be listed or approved by ICC (formerly ICBO) or UL for this application. Spacing of the support shall conform to the manufacturer's recommendations and shall not exceed 5 feet.

Conduit run across roof surface shall be supported by a durable, ultraviolet resistant, flexible, polyethylene foam block with an integral galvanized steel channel that shall be used to clamp the conduit and additional hot dipped galvanized metal framing systems to it. All fasteners and hot dipped galvanized steel framing systems shall be UL listed and made of hot dipped galvanized steel. Spacing of the support shall conform to the manufacturer's recommendations and shall not exceed five feet. All hardware shall be made of Type 316 stainless steel.

Penetrations through floor and fire-rated walls shall utilize galvanized rigid Steel (GRS) conduits and shall conform to ASTM E-814 criteria for an F-rated firestopping system.

All steel framing systems shall comply with UL 5, "Standards for Surface Metal Raceway and Fittings."

All steel framing systems attached to buildings shall conform to all applicable codes, standards and requirements.

- **Exposed Conduit in Inland Areas**

All exposed surface mounted conduit located beyond five miles of the nearest salt water body of water shall be considered to be non-coastal inland areas and conform to the requirements described in this section.

All exposed conduit shall be Caltrans Type 1, hot-dip galvanized rigid steel conduit conforming to the requirements in UL Publication UL6 for Rigid Metallic Conduit. The zinc coating shall be capable of passing a test performed in conformance with ASTM Designation: A239.

All surface mounted conduit attached to catenary poles shall be banded to the poles with Type 304 or 316 stainless steel banding spaced at not greater than 5 feet apart.

All surface mounted and I-beam supported conduit, except conduit to be attached to catenary poles, shall be attached to the surface with hot dipped galvanized steel framing channels and all associated fittings and hardware including, but not limited to, clamps, brackets, hanger rods, and fittings.

All hardware shall be made of Type 304 or 316 stainless steel.

Channels shall be secured to the surface, other than catenary poles, with type 304 or 316 stainless steel mechanical wedge anchor fasteners that firmly anchor the channel to the surface in conformance with the manufacturers recommended installation procedures. The anchors shall be listed or approved by ICC (formerly ICBO) or UL .for this

application. Spacing of the support shall conform to the manufacturer's recommendations and shall not exceed 5 feet.

Conduit run across roof surface shall be supported by a durable, ultraviolet resistant, flexible, polyethylene foam block with an integral galvanized steel channel that shall be used to clamp the conduit and additional hot dipped galvanized metal framing systems to it. All fasteners and hot dipped galvanized steel framing systems shall be UL listed and made of hot dipped galvanized steel. Spacing of the support shall conform to the manufacturer's recommendations and shall not exceed five feet. All hardware shall be made of Type 304 stainless steel.

Penetrations through floor and fire-rated walls shall utilize galvanized rigid Steel (GRS) conduits and shall conform to ASTM E-814 criteria for an F-rated fire stopping system.

All steel framing systems shall comply with UL 5, "Standards for Surface Metal Raceway and Fittings." All steel framing systems attached to buildings shall conform to all applicable codes, standards and requirements.

6.6.3 Access Points

Access points shall be provided so that the sum of all conduit bends in a run between adjacent points of access do not exceed 360 degrees.

All communications and electrical pullboxes and handholes shall be traffic rated pull boxes and handholes conforming to either Caltrans Standard Traffic Rated pullboxes shown on ES-8B of the Caltrans Revised Standard Plans or SDG&E standard 3313 handholes shown in the Underground Standards Section of the SDG&E Electrical Standards & Guide Manual SDG&E Standards, except as otherwise described below. All pullbox and handhole lids shall be: a) constructed of hot dipped galvanized steel diamond plated steel conforming to Section 75-1.05 "Galvanizing" of the Caltrans Standard Specifications, and b) labelled "MTS Railway Signaling", "MTS Communicaitons", "MTS Electrical", "MTS Fiber Optic", as applicable.

Provisions for storage of power wiring and communications cabling shall be provided within pull boxes or junction boxes near TVM and PCIDs locations to allow for secure cable storage in the event of future machine removal or new installation.

At locations where equipment is mounted to slab on grade, conduits need to be run a minimum of 2 feet below grade and sweep up into center of footprint at equipment locations.

6.7 Network Cabling Standard

Power wiring to devices shall be kept separate of communications cabling and shall be run continuously, without splices, from source to each device location including identified future locations. Electrical wiring shall be properly sized to handle the connected load of the device. Every circuit breaker shall be properly sized to protect the circuit and wiring connected to it in accordance with NEC requirements. Wiring shall conform to the requirements of Section 86-2.09 "Wiring" of the Caltrans Standard Specifications.

Communications cabling shall be kept separate of power wiring; and shall be run continuously, without splices, from termination locations in the communications enclosure or room to the termination location in the field device.

Devices with cable lengths under 330 feet from end to end shall use Outdoor rated Category 6 UTP cabling (Comscope 6NF4+ or approved equivalent) between each network device located outside of the communications cabinet and the rack mounted Category 6 48 port protected patch panel in the communications cabinet with surge protection (Citel/cylix - PCH series, or approved equivalent) . A Category 6 patch cord shall be used to complete the connection to the LAN switch.

Devices located in or near stations with cable lengths over 330 feet from end to end shall use 12 strand Single Mode Fiber Optic Cable (Corning Freedom LST or approved equivalent) between 12 port fiber distribution units, commonly referred to as patch panels. Each FDU shall have a single mode patch cord with SC connectors connecting the FDU to a media converter at both ends of the fiber optic cable. The media converters shall be connected to the device and the LAN switch using a Category 6 UTP cable.

Devices located between stations with cable lengths over 330 feet from end to end shall use available strands in the 144 strand Wide Area Network Cable and 12, 24, or 48 strand Single Mode Fiber Optic Riser Cable (Corning Freedom LST or approved equivalent) spliced together in sealed splice closures to create a fiber connection between fiber distribution unit at the field device and in the communications enclosure at the station. Each FDU shall have a single mode patch cord with SC connectors connecting the FDU to a media converter at both ends of the fiber optic cable. The media converters shall be connected to the device and the LAN switch using a Category 6 UTP cable.

Media converters in the communications enclosure shall be rack mounted in an Etherwan EMC 1600 Series “16 Bay Media Converter and Ethernet Extender Chassis”. Etherwan converters shall be 10/100/1000 Base T units.

Hardened Etherwan 10/100/1000 Base T media converters conforming to the requirements of IEC 61000-6-2 EMC “Generic Standard Immunity for Industrial Environment” shall be installed at the field device locations (e.g. VMS signs, PCIDs, TVMs, railway signaling enclosures).

Etherwan 10/100/1000 Base T hardened media converters shall be DIN Rail Mounted inside the device and be rated for a temperature range of -40 degrees F (-40 degrees C) to 167 degrees F (75 degree C).

6.8 Public Address

6.8.1 General Description

Public Address (PA) systems at stations shall comply with all applicable federal and state ADA laws and ADAAG Section 10.3.1 (14) requirements.

The primary means of access to the station PA systems shall be by way of the AIMS system PA consoles located at the OCC. The AIMS system PA consoles shall allow a user to select one or more channels at stations and zones within underground stations for broadcast of live

audio from the console microphone or pre-recorded announcements stored at the OCC or local station control unit. All audio and control originating from the OCC PA consoles shall be transmitted over WAN to the station LAN.

At typical non-underground stations, the public address (PA) system shall receive digital Voice of Internet Protocol (VoIP) utilizing Session Initiation Protocol (SIP) via the Digital Acoustics IP-7 series media gateway (or approved equivalent) from the Operations Control Center (OCC) AIMS system by way of the WAN and LAN network switches, convert them to analog audio outputs (using a Digital Acoustics IP7 or approved equivalent device), amplify them to a 70-volts signal, and distribute the sound throughout the station to bidirectional paging horns. At key designated stations where special events are anticipated the system shall include a local push to talk microphone feature.

At a typical station, the PA system will have two channels (one per platform). Each platform shall have its own channel amplifier. Amplifiers should include an automatic ambient sound adjustment feature that will increase the volume when higher levels of ambient noise is present and lower the volume the ambient noise levels decrease. The AIMS system at OCC is able to increase and decrease volume levels depending on the time of day.

Station platforms located within enclosed structures, such as underground stations in tunnels, the PA subsystem shall comply with NFPA 72 and shall be compliant with listing requirement of the California State Fire Marshall wherever used as part of a combination fire system.

The PA system serving platforms and other areas in enclosed structures shall provide all of the functionality of a non-underground station, but with access and control from additional broadcast locations and additional features that enable additional a) general announcements, b) alerts to existing or pending hazards, and c) emergency warning information to single and multiple zones within the underground station facility.

6.8.2 Noise Assessments

Where environmental documents or a site assessment identifies noise sensitive receptor(s) located within 40 feet of the back edge of the station platform, then the designer shall identify this condition to the SANDAG Project Manager and System Engineer and request direction on whether or not extensive analysis of paging horn type, placement, volume control, and resulting noise distribution in accordance with the Federal Transit Administration's "Transit Noise and Vibration Impact Assessment" guidelines is warranted and should be performed to ensure the public address design minimizes potential noise impacts to the noise sensitive receptors.

6.8.3 Layout and Standards

Generally, public address system designs and specifications should remain consistent with current practices, unless site specific conditions necessitate special consideration.

Unless site specific conditions necessitate special consideration, bidirectional paging horns shall be evenly spaced 70 to 100 feet apart and mounted to the nearest light pole along the back edge of platform at a height of approximately 11 to 15 feet above the platform to minimize variations in sound levels along the platform. Paging horns should be positioned at a horizontal angle of approximately 5 to 15 degrees from the vertical plane of the back of

platform and downward at an angle of approximately 25 to 45 degrees from horizontal. Usually, the spacing from each end of the platform to the first bidirectional paging horn should be approximately half the distance of the spacing between adjacent bidirectional paging horns. If a designer thinks site specific conditions necessitate special consideration, then the designer shall set up a meeting with the SANDAG Project Manager and SANDAG systems engineer to review the site conditions and determine how to proceed with the design development.

At sites with sensitive noise receptor(s) special paging horns with differing horizontal and vertical degrees of dispersion, power ratings, and sound pressure level may be considered for use to attempt to further reduce noise impacts on the sensitive receptor. Before performing analysis the acoustical engineer should verify the location of solid surfaces and other mitigation measures that could affect the results of the analysis.

6.8.4 Technical and Performance Characteristics

The PA system shall conform to the following requirements:

- **Power Source:** All station PA equipment shall be powered from the communications UPS, 120V 60 Hz, AC;
- **Network Interface:** 10/100 Base T Ethernet, TCP/IP protocols;
- **Audio Protocol:** G.711.8/16 Bit PCM/ uLaw;
- **Amplifier Inputs:** Power UPS 120 V, 60 Hz AC; a minimum of two channel inputs (one channel per platform)(one from each IP7 device), 2 Watt analog audio; and Station ambient noise sensor when need to address site specific environmental concerns;
- **Amplifier Outputs:** 70V, 300 Watts per channel. Typically, Channel 1 Westbound & Channel 2 Eastbound;
- **Sound Distribution:** The PA subsystem shall provide an effective sound distribution system which utilizes loudspeakers strategically placed to produce uniformly distributed audio throughout the passenger stations. Uniform audio in both tonality and sound level, at 5 feet elevation above the walking area, so that normal movement of a passenger sound receptor does not result in greater than 5 decibels changes in the sound level. PA subsystem shall maintain a uniformly distributed sound level at least 6 decibels above ambient station operating noise level measured at 5 feet above floor;
- **Paging Horns:** Paging horns shall be outdoor rated, weather proof, 70-volts. Typically, paging loudspeaker horns with a dispersion of 100 degrees per horn, root mean squared (RMS) power rating of 30 watts continuous, a sound pressure level of 121 decibels at four feet on axis, and an impedance selector switch that permits adjustment of the impedance at each set of paging loudspeakers are used;
- **Active Components:** Active components shall be solid-state devices driven off of 120V 60 Hz AC power;
- **Headroom:** The system shall have sufficient to allow a minimum increase in output of 12 dB, without increase in hum, noise, or total harmonic distortion;

- **Total Harmonic Distortion:** Not greater than 1 percent at full rated output;
- **Overload Protection:** All amplifier outputs shall be protected with automatically resetting thermal overload, short circuit and current limited protection;
- **Frequency Response:** Horn speakers' frequency response shall be a minimum of 225 Hz to 14 kHz plus or minus 3 dB;
- **Dispersion:** Angle between 60 degrees and 100 degrees each horn.

6.8.5 Stations in Enclosed Structures

PA systems in enclosed structures (e.g. in a tunnel) shall conform to all State, Federal, and NFPA requirements if used as part of the emergency response system.

The designer shall identify additional system requirements beyond those required for typical non-enclosed stations. These may include the following:

6.8.5.1 Supervision and Alarms

The PA subsystems shall be fully supervised with failure annunciation.

Emergency Management Panel, local annunciator/alarm panel, shall indicate individually the failure of any supervised circuit or equipment.

6.8.5.2 Enclosed Station System Input Priorities

Microphones shall be provided at the EMP/CP and in a Station Security room at the station. Prerecorded voice announcements shall be activated either locally or by remote control from the Operations Control Center (OCC) for informational or emergency announcements. Inputs from OCC shall be carried over the WAN or LAN. Underground station inputs from the station security room and EMP may be carried over to the PA subsystem via the WAN/LAN network. For undergrounds station, the following inputs shall be provided:

Table 6-2. – Input Priorities

Priority	Passenger Stations
1st	Station First Responder's Emergency Management Panel (EMP) Microphones
2nd	Operations Control Center -Communications Console
3rd	Prerecorded Announcements
4th	All other inputs

6.8.6 Operation Control Center Remote Access

The AIM's system at the Operations Control Center (OCC) enables PA messaging to be sent to the station. In anticipation of the addition of new stations to the system, the AIM's system shall be modified to incorporate additional station channels. The designer shall provide a detailed scope of work to the AIMs contract administrator that will detail out all additional station locations, number of channels (platforms) per station, and the names of the stations and request that the AIM's system be modified to incorporate the additional stations. The

scope of work shall include a request to modify the AIMS system and provide an anticipated activation date.

6.8.7 Ethernet Connection in Enclosed Station

Station PA system in enclosed structure shall link with the Operations Control Center and local control facilities at the station via the MTS LAN and WAN network. The PA control system shall provide audio outputs by zones to the audio system.

6.8.8 Connection to Cabling to Amplifier in Enclosed Station

Station PA system digital interface controller at the station shall provide an audio output to station zone amplifiers.

6.8.9 Connection to Cabling to Speakers in Enclosed Station

Each paging horn or speaker shall be cabled back to the communications room. Each platform shall be on its own channel. Cabling from the terminal blocks to the paging horns shall conform to NFPA and NEC requirements.

The output of each amplifier channel output shall pass through a 70 volts audio surge protection unit before connecting to each channels backboard mounted terminal block.

6.9 Visual Messaging System

The visual messaging system shall provide visual information to passengers in stations via variable Visual Message Signs (VMS) mounted in accordance with the VMS locating criteria described below. The display of the visual information shall be in compliance with the ADA Accessibility Guidelines (ADAAG) for the hearing impaired, operational and safety-related messages for patron awareness. The AIMS system located at the Operations Control Center (OCC) will generate messages for display at each passenger station.

The VMS system shall interface with the AIMS centralized message generator (including message creation, storage and selection) system, and dispatch functions at the OCC for individual stations, groups of stations, and all station sign activation and display. Each passenger station VMS shall accept message inputs from the AIMS centralized processing unit located at the OCC.

6.9.1 General

Visual Message Signs (VMS) at stations shall conform to ADAAG sections 10.3.1 (14) and 4.30.2, 4.30.3, and 4.30.5. Often VMS signs are procured under separate contract and installed as owner furnished material; the designer shall meet with the SANDAG project manager and systems engineer to determine if the VMS signs shall be included in the contract documents and shall request specifications for the VMS signs if directed to include the signs in the contract documents.

All new and station retrofit projects shall incorporate the latest VMS conforming to SANDAG and the operator requirements. At SANDAG direction, the designer may be required to research and recommend alternative VMS equipment. The designer shall include in the contract documents, VMS systems and components that are consistent with latest equipment

used on the existing system, unless otherwise directed by the SANDAG Systems Engineer. The design shall include all necessary details for VMS installation including, but not limited to, sign frame foundations, sign frames and/or mounting details, and cabling requirements from Communication enclosures to VMS.

The VMS designer shall contact the SANDAG Project Manager and Systems Engineer to find out if the Variable Message Signs will be procured under separate procurement contract and furnished to the station construction contractor as owner furnished material or if the signs specifications should be included in the construction contract. When signs are to be procured and installed by the station construction contractor the specifications for the signs shall require signs to conform to the same specifications and standards as those procured through SANDAG's most recent procurement contract to ensure the signs will be of equal or better quality, unless otherwise directed by SANDAG's Systems Engineer.

The VMS system shall interface with the existing AIM platform, as supplied by Arinc, via the WAN/LAN. VMS system shall be integrated into the existing system so that signs and audible announcements can be controlled from Operations Control Center (OCC). VMS equipment specified shall be capable of being programmed to communicate visual messages on one platform or both platforms from central control.

6.9.2 Description

The following criteria shall be used when designing visual message sign (VMS) supports:

- Top of sign shall be mounted between 11 and 13 feet above the platform;
- VMS design load shall be 200 pounds (100 pounds from each sign mounting bracket);
- Electrical power: As described in Section 6-9.5;
- Communications: As described in Section 6-9.4.

Support frames shall be designed to include the load of the signs, video surveillance camera equipment and construction loads. VMS sign frame supports shall not deflect more than 0.5 inches from vertical at the top of the post under seismic or a wind load conforming to the latest requirements of the CBC. The tip of the cantilever support arm shall not deflect more than 2 inches horizontally under seismic or the CBC wind load.

6.9.3 Location VMS Signs, Frames, and Foundations

Design plans shall include four VMS Signs (two per platform).

Every two sided visual message sign shall either be mounted from a sign frame or from a structure such as a platform canopy structure.

If the signs are mounted below the canopy structure they shall be located at the same offset distance from the track and at the same heights as described below for the VMS sign frame support and conform to the same structural wind loads and deflection criteria as described above for VMS sign frame supports. Each two sided sign shall have two 1 inch conduits running to junction boxes near the sign (one for electrical and one for communications). Half

inch seal tight flexible conduit shall be run from the junction box to the VMS. The electrical and communications cabling shall be the same as described below.

VMS sign frame supports shall be oriented perpendicular to the track with the center of the mast located about 6 inches to 2 feet from the back edge of the station platform, unless specific site conditions dictate otherwise and an alternate mast location is approved by the SANDAG systems engineer on a site specific basis. The frame shall extend so the mast arm extends to: a) 6.1 ft plus or minus 1 inch adjacent to tracks that are *solely used for light rail transit*; b) 8.6 ft plus or minus 1 inch for tangent track and curved tracks with less than 12 degrees curves adjacent to track that is utilized by both freight trains and light rail transit vehicles (with a CPUC determination of limited space); and c) 9.6 ft plus or minus 1 inch for curved tracks with over 12 degree curves adjacent to track is utilized by both freight trains and light rail transit vehicles in accordance with California Public Utility Commission (CPUC) General Order (GO) 26-D requirements. NOTE: the 8.6 clearance on curved track with less than 12 degree curves when the CPUC determines space is limited, if the CPUC does not make that determination that space is limited, then the minimum dimension on curved track shall be increased to 9.6 feet plus or minus 1 inch. At location on curved track where space is limited the 9.6 feet plus or minus 1 inch clearance may be reduced in accordance with section 3.16 of CPUC GO 26 and after the CPUC determines space is limited. The minimum length of the mast arm from tip located closest to the track to bolted flange near the mast shall not be less than 66 inches.

Typically, VMS frames and foundations shall be located from each end a distance equal to approximately one fourth of the total length of the platform (e.g. total length of 360 feet /4 = 90 feet from each end of the station platforms).

If the typical VMS Sign Frame location is located within 30 feet of a planned shelter location, then the designer shall perform line of sight calculations and make necessary adjustments to the sign frame location to ensure the VMS visibility is maximized. The analysis should look at scaled elevation view taken from the trackway that shows the location and height of the shelter and the VMS sign and the line of sight to the top of the VMS sign as observed from the eye of a passenger that is 5.5 feet above the platform and the passenger is standing 3 feet beyond the end of the shelter that is located furthest away from the VMS sign. If the top of the VMS sign is located about 11 feet above the platform and the shelter overhang is less than 11 feet above the platform, then the most desirable location for the VMS sign frame may be half away between the adjacent shelters.

The designer shall share the results of the line of sight analysis with the SANDAG systems engineer and the SANDAG project manager at a review meeting and provide a recommendation on where to adjust the VMS frame and foundation location. The recommendation should show the line of sight from the proposed new VMS sign location. The objective of moving the VMS sign frame location is to maximize visibility of the sign by trolley passengers while keeping shelters in locations that will provide coverage to passengers in areas passengers are likely to gather while they are waiting for a trolley.

6.9.4 Communications Provisions

Etherwan 10/100/1000 Base T hardened media converters conforming to the requirements of IEC 61000-6-2 EMC “Generic Standard Immunity for Industrial Environment” shall be DIN

Rail Mounted inside the Variable Message Sign and be rated for a temperature range of -40 degrees F (-40 degrees C) to 167 degrees F (75 degree C).

Each Variable Message Sign shall have an Ethernet connection to the LAN switch located in the Stations Communications house/cabinet. Ethernet connection to the LAN switch in the Communications Enclosure or Room shall be via: a) a Category 6 cable terminated to the rack mounted Category 6 patch panel or b) a 12 strand single mode fiber optic riser cable (Corning Freedom LST or approved equivalent) with SC terminations, media converters, and Category 6 patch cords with RJ-45 connectors at both ends.

Media converters in the Communications Enclosure shall be mounted in the 19 inch rack in an Etherwan EMC1600 16 Bay Media Converter Chassis or approved equivalent.

6.9.5 Electrical Provisions

Each visual message board shall be supplied with single-phase, 3 wire, 120-volt AC, 60-Hertz power having a voltage variation plus 10 percent and minus 15 percent, each double sided VMS sign shall be on a dedicated 3 wire, 120 VAC 552 Watt circuit.

6.9.6 Raceways and Pullboxes

Each VMS Sign Frame shall be connected to the station electrical service panel and the station Communications Enclosure via the Local Area Network raceway and pull box system described in the Local Area Network (LAN) section.

6.9.7 VMS Messaging

The AIMS System at the OCC shall enable the VMS subsystem to function in conjunction with the PA subsystem. For the pre-programmed messages VMS shall be able to display equivalent text as announced on the PA subsystem simultaneously for the hearing impaired passengers, in compliance with the ADA Accessibility Guidelines (ADAAG).

The AIM system shall interface with the train control and / or other vehicle detection system to provide information to the passengers.

The System shall provide automatic announcements that include:

- Information on route, final destination, time of arrival of the next the trains approaching a particular platform – “Next Train”;
- Information on service interruptions or delays such as “The approaching train is not in service, please stand clear”;
- Day, Date, and Time synchronized to a master clock at the OCC;
- Emergency instructions; and
- Other pre-recorded messages to be determined.

6.10 Fare Collection Technology

6.10.1 General

Fare Collection Technology at LRT Stations is comprised of four types of equipment:

- Ticket Vending Machines (TVMs);
- Passenger Card Interface Devices (PCIDs);
- Ticket kiosks;
- Portable ticket trailers.

The designer shall indicate locations of Fare Collection Technology equipment on plans as well as conduit locations. The specifications shall provide power and connectivity requirements as identified in this design criteria and should be consistent with language used in past projects, unless otherwise directed by SANDAG systems engineers.

Generally, platforms shall be designed for the fare collection equipment in accordance with the Standard Plans. Where specific conditions dictate changes to the fare collection location and conduit layout shown in the standard plans SANDAG, shall approve the layout prior to final design. For location and clearance requirements, see Volume 1, Chapter 6 – Transit Centers, “General Circulation and Access” Section.

Unless otherwise directed, station construction plans shall indicate that fare vending equipment shall be procured under separate contract and installed by San Diego Trolley. For more specific information regarding ticket vending machines, see the ticket vending machines procurement specifications.

The plans and specifications shall also indicate that the station contractor shall submit a written request to San Diego Trolley and the Engineer for the installation of fare vending equipment, perform continuity and resistance tests on electrical conductors, and perform ethernet and fiber optic tests. All cable and functional testing shall be completed prior to the Contractor receiving partial or complete relief of maintenance of a station for schedule and payment.

6.10.2 Locating Ticket Vending Machines and Passenger Card Interface Devices

Location of Ticket Vending Machines and Passenger Card Interface Devices shall conform to the following:

- TVMs shall be positioned under station shelters where shelters are of sufficient size and designed to accommodate TVMs. TVMs when under shelters shall be located to minimize obstructing the area under the shelter, and positioned to minimize sun and glare on the interface screen, and protect the TVM and patrons from rain. TVMs shall be in well lit locations along the back of the platform and evenly distributed along the platform. Lighting shall be configured to illuminate the front of the TVMs without creating glare on the TVM display screen that would make it difficult to read. The lighting should be configured to enable video surveillance systems to take images of people standing near the ticket vending machines;

- PCIDs shall be positioned at access points to a station that are easily accessible, visible and on, but not obstructing, pathways for patrons entering the trolley station platforms. All access points to a station platform shall have provisions for PCIDs. All high volume access points shall be equipped with PCID equipment. The designer shall not locate PCIDs in the landing areas above access ramps (generally extending 4 to 5 feet behind the top of ramp);
- TVMs shall be positioned to allow for queues at fare collection areas that do not block through passenger traffic. Where stations are either elevated or subterranean fare collection equipment (TVM & PCID) shall be located on plaza and mezzanine areas. In addition placement shall allow for clear access for maintainability including access to panels, and ability to remove and replace.

6.10.3 Ticket Vending Machine Equipment Pads and Connections

At each ticket vending machine location at the station the platform slopes shall not exceed 2 percent transverse and 2.4 percent longitudinal. The design of each TVM site shall conform to the following requirements:

- TVMs shall be placed on eight inch thick reinforced concrete pads with dimensions not less than 3.5 feet long by 2.5 feet wide;
- The pad surface shall be as level as possible to minimize the gap between equipment bases and finish surface of pad;
- Two 1-inch conduits (one for power and one for communications) shall be shown on the plans connecting the nearest communications and electrical pull boxes to and through the concrete TVM pad at a point near the center of the TVM in conformance with Section 6.6 “Cabling Raceways and Access Points” of this Design Criteria;
- A properly sized three-conductor (Line/Neutral/Ground) THWN dedicated 120V, 60 Hz, 20 amp AC circuit with dedicated neutrals long enough to connect a TVM set on the pad to the station electrical panel shall be coiled up in the nearest pull box. The design shall identify dedicated breaker in the electrical panel. Circuit breakers shall be left in the "off" position until after San Diego Trolley completes the Ticket Vending Machine installation. Each TVM operates on primary power from a single-phase, 120-volt, 60-Hertz service having a voltage variation plus 10 percent and minus 15 percent. PCID wiring shall be comprised of a minimum of three #12 AWG insulated conductors sized per the National Electrical Code (NEC);
- Cabling to connect TVMs to the Ethernet Network utilizing communications cabling from the LAN switch to the TVM site shall conform to the requirements specified in Section 6.7 “Cabling Standards” of this Design Criteria.

6.10.4 Passenger Card Interface Device Connections

At each passenger card interface device (PCID) location at the station the platform slopes shall not exceed 2 percent transverse and 2.4 percent longitudinal. The design of each PCID site shall conform to the following requirements:

- The owner furnished PCID shall be anchored into the platform at the designated locations;

- Two 1-inch conduits (one for power and one for communications) shall be shown on the plans shall connect the nearest communications and electrical pull boxes to the center of the PCID location in conformance with Section 6.1.7 “Raceways and Pull Boxes” of this Design Criteria;
- Each conduit at the PCID location shall have a treaded coupler set flush with the finish surface and contain a threaded plug in it;
- A properly sized three-conductor (Line/Neutral/Ground) THWN 120V, 60 Hz, 20 amp AC electrical circuit with dedicated neutrals long enough to connect a PCID set over the conduits to the UPS in the station communications enclosure or room shall be coiled up in the nearest pull box. Each PCID shall be connected to the UPS via: a) a backboard mounted four gang electrical box and ESO Cord that plugs into the UPS, or b) a UPS electrical panel. Each PCID operates on primary power from a single-phase, 120-volt, 60-Hertz service having a voltage variation plus 10 percent and minus 15 percent. PCID wiring shall be comprised of a minimum of three No. 12 AWG insulated conductors sized per the National Electrical Code (NEC);
- Cabling to connect PCIDs to the Ethernet Network utilizing communications cabling from the LAN switch to the PCID site shall conform to the requirements specified in Section 6.7 “Cabling Standards” of this Design Criteria.

6.10.5 Permanent Ticket Kiosks and Portable Ticket Trailers

At stations identified as requiring accommodations for a permanent ticket kiosk or portable ticket trailer in the preliminary engineering or project scope of work, an eight inch thick reinforced concrete kiosk or trailer pad with dimensions not less than 4 feet 1 inch (169 inches) long by 6 feet 2 inches (74 inches) wide shall be included in the station design plans. The identified kiosk or trailer pad site shall have a minimum vertical clearance of 7 feet 6 inches (92 inches) above the pad. The pad shall be located in an open area on the primary special event boarding platform in a location that is easy to access and convenient to persons entering the station while not impeding normal pedestrian and train movement.

Portable ticket trailers are often used at stations serving low numbers of special event patrons. At stations likely to regularly serve significant numbers of special event patrons, SANDAG shall include in the project a permanent ticket kiosks.

The design shall provide for the following:

- A paved access road a minimum of 7 feet wide leading from the parking lot or nearest road to the pad;
- A paved access road a minimum of 7 feet wide leading from the parking lot or nearest road to the pad;
- Two 1-inch conduits (one for power and one for communications) shall be shown on the plans connecting the nearest communications and electrical pull boxes to and through the pad at a point near the power and communications cables entry point to the kiosk or trailer in conformance with Section 6-1.7 “Raceways and Pull Boxes” of this Design Criteria;

- The design shall include power cabling from the station electrical panel to the kiosk or trailer site. The kiosk or trailer shall be served from a dedicated circuit. Depending on the trailer or kiosk the dedicated circuit shall be either a 220V AC 60 Hz 20 A circuit or a 120V 60 Hz 30 A circuit. The designer shall contact San Diego Trolley fare revenue department to find out the type of dedicated circuit required;
- Cabling to connect kiosks and trailers to the Ethernet Network utilizing communications cabling from the LAN switch to the kiosk or trailer site shall conform to the requirements specified in Section 6.19 “Cabling Standards” of this Design Criteria.

6.11 Traction Power System SCADA

Traction power substations shall be connected to the Local Area Network switch in the nearest trolley station’s communications enclosure or room. The connection shall conform to the requirements described in Section 6.18 of this Design Criteria.

Traction power substations communicate to the AIMS system at the Operations Control Center (OCC) utilizing standard TCP/IP protocols. The traction power SCADA system utilizes Modbus protocol.

All IP Addressing shall conform to the MTS IP Addressing Standard and all bit addressing shall be consistent with that which has been developed in past SANDAG and MTS projects.

6.12 Signaling System SCADA

Non-vital Railway Signaling SCADA system connection at each interlocking shall be connected to the Local Area Network (LAN) switch in the nearest trolley station’s communications enclosure or room. The connection shall conform to the requirements described in Section 6.3 of this Design Criteria.

The Non-vital Railway Signaling SCADA system communicates with the AIMS system at the Operations Control Center (OCC) utilizing standard TCP/IP protocols. The Non-vital Railway Signaling SCADA system utilizes Genesis protocols.

All IP Addressing shall conform to the MTS IP Addressing Standard and all bit addressing shall be consistent with that which has been developed in past SANDAG and MTS projects.

6.13 Bi-Directional Train to Wayside Communications

6.13.1 General

The Bi-Directional Train-to-Wayside Communication system at each station shall be connected to the Local Area Network (LAN) switch in the nearest trolley station’s communications enclosure or room. The connection shall conform to the requirements described in Section 6.3 of this Design Criteria.

The Bi-Directional Train-to-Wayside Communication system communicates with the AIMS system at the Operations Control Center (OCC) utilizing standard TCP/IP protocols. The Bi-Directional Train-to-Wayside Communication system utilizes Genesis protocols.

All IP Addressing shall conform to the MTS IP Addressing Standard and all bit addressing shall be consistent with that which has been developed in past SANDAG and MTS projects.

6.13.2 Equipment Compatibility

The TWC interrogator shall be H&K HCS-V, or approved equivalent, capable of bi-directional data transmission. Data rate shall meet a minimum of 100 kBits per second. The TWC equipment shall be compatible with the existing LRV and wayside TWC system. The Contractor shall demonstrate by performing tests that the new TWC equipment is compatible with the existing system. Wayside interrogators, transmits and receives a 100 KHz interrogation signal through a loop antenna installed between the rails. On receipt of the interrogation signal, while the LRV antenna is over a loop, the vehicle-borne transponder responds with a low power signal encoded with a 19-bit message. On validation by the interrogator, the message is passed on to specific electronic application cards in the interrogator, transmits and receives information over the WAN via the Ethernet port and network switch.

6.13.3 TWC Loop Antenna and Loop Converter

The TWC loop antenna shall be constructed in a figure “8” pattern as shown on the Plans and specified in these Special Provisions. Each loop antenna shall be connected to a tuned filter/loop connector (TF/LC) adjacent to the loop as required, and via shielded twisted No. 12 AWG, 2 pair conductor to the loop interrogator, from the TF/LC.

The TWC Loop Converter shall be the H&K HCS-V-LC (Part number 44 783 040) or approved equivalent, and be capable of providing communications required for TWC system operation.

Each loop antenna shall consist of one turn of insulated, stranded, copper wire suitable for a 30-year life in direct burial wet and dry applications, with a conductor size minimum of No. 8 AWG. The wire shall meet the requirements of Article 310 of the National Electrical Code. Insulation shall be type RHW, RHH, USE, or XHHW with a thickness of 45 mils.

6.13.4 Interrogators

Interrogators shall provide the functional information required to deliver a complete functional system.

The interrogator units shall be H&K type HCS-V bi-directional units, or approved equivalent, and shall be able to be mounted in the existing standard EIA-310-D, 19 inches rack. The interrogator shall have an overall width of 19 inches, approximately 8.5 inches deep, and occupy approximately 3U of rack space.

The interrogator shall contain a backplane, power-supply, transmit/receive cards, loop scanner card, timing card, shift register/buffer card and an application backplane. It shall be powered by 120 volts ac, 60 Hz source. The interrogator card rack shall contain space for application cards, which plug into the backplane and receive power from the interrogator power supply.

6.13.5 Communications Card

The interrogator unit shall include serial communication card with a standard RJ-45 Ethernet port for connection to the gigabit LAN Ethernet network switch using standard TCP/IP protocols.

6.13.6 Serial Output/Input Card

The serial output/ input card shall take data input and output signals from the back-plane of the TWC interrogator unit, provide signal level shifting to RS-232 levels, and provide RS-232 data input and output signals to a DB-9 male connector. The serial output/input card shall output train, route, and loop identification information.

The serial output/ input card shall fit in the interrogator's card rack and transmit and receive data and control inputs through a connector that plugs into the back-plane of the interrogator unit.

The serial output/ input card shall process transmit and receive data thru a MAX232 integrated circuit, or an approved equivalent, with a master/ slave configuration. The mating half of the connector shall be a standard DB-9 male connector. Pin 5 shall be connected to ground, Pin 2 shall be RXD, and Pin 3 shall be TXD, unless otherwise approved. Pin selections shall conform to industry standards.

The serial output card shall be a printed circuit board. The printed circuit board and all components connected to the board shall be industrial grade or better.

The power-supply and ground for the serial output card shall be obtained from the back-plane of the interrogator.

The serial output/ input card shall transmit the same information via the Ethernet port.

6.14 Electrical Grounding and Power Surge Protection

Every communications enclosure (cabinet, precast building, and room) shall contain grounding and electrical surge suppression system as described herein. All cabling from field devices or facilities external to the communications enclosure shall be protected from surges utilizing surge arresters in conformance with standard practices.

Racks, communications equipment, and electrical equipment shall be grounded in conformance with applicable regulations, manufacturers' requirements, and standard practices. Communications cabinets, buildings or rooms shall be grounded with a grounding system. The grounding system shall consist of grounding bars and ground rods that are interconnected with bare copper stranded wire and bonding connections to concrete encased electrodes (rebar) in cabinet, building and room foundations. The ground conductor, ground rods, and bonding connections shall be connected by permanent bonding methods. Subsurface electrical ground system elements shall be permanently bonded by exothermic welding methods. Mechanical connections shall not be accepted as a permanent bond. The communication grounding system shall be bonded to the Station's Grounding Electrode System. See Section 2.7.4 "Grounding". If the Communications cabinets, buildings or rooms are to be located at existing stations with more than one grounding system, the

communication's ground system shall be connected to the grounding electrode system of the electrical service that supplies power to the communication equipment.

Enclosure shall have surge suppressor installed between the incoming utility AC source and the grounding bar.

The surge suppression shall be constructed using multiple surge current diversion arrays of metal oxide varistors (MOV), matched to a variance of ± 1 volt. The array shall consist of multiple gapless metal oxide varistors, with each MOV individually fused. The arrays shall be designed and constructed in a manner that ensures MOV surge current sharing. No gas tubes, silicon avalanche diodes or selenium plates/rectifiers shall be used. The status of each array shall be continuously monitored and a green LED shall be illuminated if the array is in full working order. All protection modes, including N-G, shall be monitored and internally fused for compliance with NEC article 110.9, 110.10 and 285.

Surge suppressors protecting electronic components shall conform to UL 1449 third edition and have the following minimum ratings:

- Clamping Voltage, < 330 Volts;
- 1350 joules at 8X20 (s pulse);
- Spike Capacity, 52,000 amps;
- Protection Mode, L-N, N-G, L-G;
- Let-through Voltage, < 35 Volts;
- Response Time, < 1ns.

The Surge Suppression System shall be installed in all new communications enclosure and wired to the electrical subpanel. Surge Suppression System shall be of the Liebert AccuVar Transient Voltage Surge Protection (TVSS) device, or an approved equal.

The TVSS shall be rated for a Surge Current of 65KA per mode, be sized for the existing nominal voltage and electrical source configuration at each station, have all protection modes (Line to Neutral or Line to Line, Line to Ground, Neutral to Ground) that are appropriate for the type of existing electrical configuration at each site, and have LED's, Enhanced Electro-Magnetic Interference / Radio Frequency Interference, and alarm relay contacts (normally closed) to provide status and malfunction information. The TVSS and all components in the suppression path (including all current diversion components) maximum continuous operating voltage shall be greater than 125 percent of the nominal system operating voltage to ensure the ability of the system to withstand temporary root-mean-square (RMS) over-voltage. The operating frequency range of the TVSS shall be at least 47-63 Hz.

The TVSS shall be capable of protecting against and surviving at least 6000 10 kA surges per ANSI/IEEE C62.41-1991 Category C without failing or degrading the UL 1449 surge suppression ratings by more than 5 percent.

All protection modes of the TVSS shall be internally fused with I²T capability to allow the suppressor's maximum rated transient current to pass through the TVSS without fuse

operation. If the rated I²T characteristic of the fusing is exceeded, then the fusing shall open in less than one millisecond and clear both high and low-impedance fault conditions. The fusing shall interrupt up to 200kA symmetrical fault current with 600VAC applied. The TVSS's over-current protection circuit shall be monitored and provide indication of suppression failure and operability. Conductor level fuses or circuit breakers internal or external to the TVSS shall not be acceptable.

The system performance ratings shall be in conformance with UL 1449 listing ratings for IEEE C62.41 Category B3 impulse waveforms of 6 kV 1.2 x 50 microseconds, 3 kA 8 x 20 microsecond wave shapes. The maximum UL 1449 listed surge rating for all protection modes shall not exceed 400 volts. The response time shall be 0.5 nanoseconds.

The SSA's shall provide a minimum of 50 dB noise attenuation for 50 ohm measurement method, 10 kHz to 500 MHz. The SSA shall be UL 1283 listed.

If the Contractor proposes to furnish equivalent equipment to that identified in these Special Provisions, then the equivalent equipment then the Contractor shall demonstrate that the equipment provides all of the same or greater functionality than the equipment specified. Proposed equivalent products shall comply with all of functional, operational, material, design submittal, and all other requirements identified in these Special Provisions and shown on the plans. The equipment shall be UL listed.

All duplex outlets located near the MTS 19 inch equipment racks shall be protected by the TVSS. The Contractor shall determine the Nominal System Operating Voltage and Electrical Source Configuration at each site and size the TVSS accordingly. The TVSS shall protect circuits rated for 120 Volts, 950 Watts, 1,400 VA, except as otherwise specified.

6.15 Uninterruptible Power System and Power Generation Facilities

Each Communications Cabinet, Building, or Room shall contain an Uninterruptible Power Supply System (UPSS) designed to provide continuous power to the following communications and station equipment: WAN, LAN, PCID, Video Surveillance, Public Address, Intrusion and Temperature Sensing PLC, and all fire life safety system loads in conformance with federal and state requirements. Additional loads may be added to the UPSS, when authorized or requested by the SANDAG Systems Engineer. The designer shall make the SANDAG Systems Engineer aware of all requests for additional UPSS loads.

The UPSS shall be sized to provide power to connected loads and be provided with adequate batteries for a runtime period of not less than 90 minutes for the connected loads. When the station is equipped with backup or emergency power generation equipment, the power generation equipment shall be properly sized to supply power to the station UPSS loads, and the UPS runtime shall be for a period of not less than 45 minutes.

A typical UPSS for Communications Cabinets will consist of a properly sized branch circuits feeding dedicated UPS receptacles, cord and plug connected, rack mounted UPS's, and cord and plug connected loads. A typical UPSS for Communications Buildings or Rooms will consist of a properly sized branch circuits, maintenance bypass switch panel, rack or floor mounted UPS, and a dedicated panelboard for UPS powered loads.

The UPS's shall be provided with Network Management Card with environmental monitor capabilities and a Dry Contact I/O Accessory, an Emergency Power Off function that will allow activation by a contact closure from a remote location. The UPS's Network Management Card shall be connected to the LAN, and the Dry Contact I/O Accessory shall be connected to the PLC for activation of the Emergency Power Off function. Refer to Section 6.16, "Temperature Sensing, Intrusion Detection, and TWC Processing System" and the "Typical PLC Wiring Diagram" of the Standard Plans for additional information.

The UPSS shall comply with Section 6.1.3 - "Environment", and UPS's shall meet the following requirements:

6.15.1 Topology

The Communication Cabinet UPS's shall be of the line interactive type, and Buildings and Rooms UPS's shall be of the double conversion online type.

6.15.2 Batteries

The battery system shall be of modular construction with field replaceable battery modules housed within the UPS or additional enclosure. The batteries shall be of the valve regulated lead acid type.

6.15.3 Voltages

UPS's input and output voltage shall be compatible with the equipment requirements, typically 110V for typical unenclosed stations.

6.15.4 Battery Charging

The UPS battery charging system shall incorporate overcharge protection to prevent battery damage and to prevent batteries from emitting hazardous levels of combustible gases. The recharge time of a battery plant shall not be greater than four times the discharge time period, e.g., discharge 45 minutes, recharge 3 hours.

6.16 Temperature Sensing, Intrusion Detection, and TWC Processing System

All communications enclosures (cabinet, precast building and room) shall contain a remote terminal unit (RTU) with temperature and intrusion sensors connected to it and network connections enabling TWC system information from the Station Interrogator to be reduced before forwarding it on to the OCC.

The RTU shall be programmed with two temperature thresholds. The first threshold will initiate an alarm that will notify the OCC of communication enclosure over-temperature issues, and when the second threshold is reached the system will initiate an organized shut down of the equipment in the enclosure or room.

The RTU shall send alarms to the OCC when a door sensor senses an open door in the station communications enclosure. Alarm activation shall be time delayed to allow deactivation with a key or control code from inside Communications house or cabinet. An intrusion alert occurs when the Communications house/cabinet door is opened. The ability at OCC to read/write numeric identification numbers and log ingress and egress shall be

provided. An intrusion alarm occurs if the alert is not deactivated within a selectable time period. Alarms shall be indicated to the OCC via the RTU interface.

6.17 Bicycle Locker Networking Provisions

All bicycle locker locations shall have provisions installed for future network and electrical connections.

A 1-inch communications conduit shall be installed from the bicycle locker location to the nearest communications pull box or to the communications cabinet. An additional 1-inch conduit shall be installed from the bicycle locker location to the nearest electrical pull box or electrical panel to supply 120V AC power to the locker should it be necessary. Both conduits shall have threaded PVC couplings on the ends and the tops set flush with the finish surface. Threaded plugs shall be screwed into the couplings.

6.18 Axel Counters

In areas of the light rail system where there is railway signaling doesn't control train movements, axel counters can be used to identify vehicle movements for next train messaging systems. These axel counters are considered to be non-vital network devices and the information can be sent over the non-vital network. These devices shall be networked using the Ethernet network and TCP/IP protocols.

6.19 Vehicle to Wayside Wi-Fi Wireless Local Network Communications

San Diego Trolley, Inc. is currently investigating an IEEE 802.11 Wi-Fi Wireless Local Area Network (WLAN) solution to enable active real-time digital communications between the on board vehicle radio equipment and wayside radio units distributed along the wayside and linked to the OCC via the LAN and WAN connections.

Designer shall incorporate into future design plans vehicle to wayside Wi-Fi WLAN communications that will enable bi-directional real time communication between the vehicle and the wayside. The design of the system shall be fully compatible with the on board vehicle Wi-Fi WLAN equipment to be selected by San Diego Trolley, Inc.

Typically, wireless to fiber optic network connections shall be made in the stations communications cabinet. Wireless repeater units may be used to repeat the signal around curves and obstructions. Additional connections to the fiber optic cable network may be added if it will reduce system deployment costs and/or improve system performance and reliability.

A Wi-Fi WLAN connection to the LAN and WAN shall be made in the communications cabinet, room, or prefabricated building at each station.

6.20 Voice Radio Communication System

The existing Radio Communications System (RCS) provides two-way voice communication between a dispatcher in the OCC, train operators, supervisors, maintenance personnel, and security personnel. The radio system shall provide working level, duplex voice channel

coverage over the entire SDTI service territory. MTS is in the process of upgrading the RCS system to a Simulcast RCS system.

6.20.1 RCS Upgrades to Accommodate New Territory

Designers of new territory, new line segments or line extension projects, shall analyze the Simulcast RCS planned to be installed by MTS's maintenance vendor Day Wireless and evaluate the existing system and line segment corridor, determine required system enhancements to extend coverage area to cover new line segment, prepare recommendations, design system enhancements, and prepare contract documents required to expand the existing Simulcast RCS in order to link the project area. These enhancements of the existing system shall include a review of existing radio system facilities and equipment located on mountain tops, in existing line segments at various points along trolley lines, and in the communications rooms at the Operations Control Center (OCC).

The designer shall contact and obtain current Simulcast RCS system information from Tom Tupta at SDTI and MTS/ SDTI radio system maintenance vendor, currently Day Wireless. MTS's point of contact at Day Wireless is Fernando Hernandez.

Should the designer of the new line segment determine existing system equipment: a) is no longer being manufactured; b) does not comply with to the latest regulatory requirements and more restrictive standards; or c) will be over 10 years old by the time the line extension or new line is planned to being revenue service, then the designer shall recommend a substantive overhaul to the existing radio system. The designer shall identify all components requiring overhaul and prepare a scope of work with cost estimate for the work required to substantively overhaul the radio system.

If it is determined that existing system only needs to be enhanced with additional links, then the designer shall develop and submit recommendations with cost estimates to the project manager detailing ways to link the project area to the SANDAG project manager and SANDAG systems engineer for approval. The designer shall include in the design of the system the new radio communication links required.

The designer shall also make recommendations regarding technological changes that should be considered that would improve the system and ensure the system remains compliant with current industry standards and requirements.

Build-Out expanded coverage shall be part of the radio subsystem planning. Including: a) RF propagation studies utilizing software-based coverage prediction and simulation tools that analyze geographic factors to determine equipment configurations to ensure adequate simulcast RCS coverage, b) location of additional transmitter/ receiver repeater sites, b) additional right of way access rights required, c) facilities, and d) equipment upgrades to accommodate the enhanced simulcast RCS system.

OCC spatial equipment needs shall review existing conditions and provide revised equipment rack layouts. Analysis of the OCC needs shall be performed in conjunction with other OCC system upgrades required to accommodate the new light rail territory and other planned enhancements to the OCC, including but not limited to Centralized Train Control (CTC), VMS, PA, and Video Surveillance systems enhancements.

RCS enhancements shall be shown in the OCC Facility Enhancement recommendations.

New equipment shall be capable of operating with 12.5 kHz bandwidth capabilities, and, 6.25 kHz if available. New remote receivers shall be added as needed. New receivers shall be compatible with existing equipment such that new equipment audio may be "voted" with the existing remote receivers' audio. New transmitter equipment, shall be capable of supporting transmissions with a 12.5 kHz bandwidth and if available, 6.25 kHz.

6.20.2 Existing RCS Frequencies

SDTI is operating Operations Channels 1, 2, 3, 4, 5, and 6 on transmit frequencies 160.665 MHz, 160.380 MHz, 160.710 MHz, 161.295 MHz, 161.565 MHz, and 160.530 MHz, and receive frequencies 160.935 MHz, 160.905 MHz, 160.415 MHz, 161.295 MHz, 160.755 MHz, and 160.530 MHz, respectively.

Table 6-3. – RCS Frequencies

Channel No.	Transmit Frequency	Receive Frequency	Site Locations
1	160.655		Point Loma
1		160.935	San Ysidro, Iris, H Street, Point Loma, Old Town, Qualcomm, Central
2	160.380		San Miguel
2		160.905	Encanto, Helix, Central, Point Loma
3	160.710		
3		161.415	Central, San Ysidro, Iris, H Street, Point Loma, Old Town, Qualcomm, Encanto, Helix
4 SIMPLEX	161.295	161.295	
5	161.565		Point Loma, San Miguel, Old Town, Qualcomm
5		160.755	San Ysidro, Iris, H Street, Point Loma, Encanto, Helix, Central, Old Town, Qualcomm
6 SIMPLEX	160.530	160.530	

6.20.3 Additional Radio Frequencies

An interference study shall be performed whenever a new radio frequency is proposed within the SDTI service territory. Mathematical calculations of intermodulation products shall be made and filter cavity requirements identified at any transmitter site, or proposed site, affected by the additional frequency.

The designer will also be responsible for coordinating the Federal Communications Commission (FCC) required licensing.

The designer shall perform a site evaluation study before locating equipment.

6.20.4 Transmitters

Transmitter sites shall have two redundant sets of equipment, with the exception of the antenna and backup battery supply. The equipment shall include a band pass cavity located before the transmitter, to protect against interference defined in this section, and a backup power supply. The backup set of equipment shall automatically be brought on-line whenever the primary set of equipment fails to function properly.

A clear voice test shall be conducted whenever a new radio transmitter site is considered. The test shall be designed to determine the suitability of the site prior to performing equipment installation. A second test shall be conducted following equipment installation to ensure compliance with the signal strength requirements set below.

The system coverage shall be the signal strength above a minimum of 12 dB SINAD signal using a specific effective radiated power transmission for the test and measured over the entire length of the respective designated line, except that portions of the line having less than this coverage shall total not more than 500 feet in any 10-mile length of the designated line;

A Radius P200 portable radio unit or equivalent, transmitting from all points over the entire length of the designated line, shall produce, at one or more receiver repeaters on the channel, a signal strength above a minimum 12 dB SINAD signal. The overlap of this coverage between two adjacent receiver-repeaters shall extend not less than 500 ft.

A test shall be conducted to determine whether radio frequency interference from the newly installed radio equipment, i.e., transmitter noise, receiver desensitization, or intermodulation product interference will, in fact, detrimentally affect the operation of existing radio equipment in the general area.

A test shall be conducted to determine whether radio frequency interference from existing radio equipment, i.e., transmitter noise, receiver desensitization, or intermodulation products interference, will detrimentally affect the operation of the newly installed equipment.

6.20.5 Receivers

Receiver sites shall be identified as required to provide compliance with the clear voice test specified in Section 3.6.2.3. The receiver equipment shall be similar to the transmitter equipment, including backup battery supply, except it shall not rebroadcast the voted receiver signal.

6.20.6 Portable Radios

Portable radios shall be Radius P200 or an approved equal. An approved equal radio will be one that meets the technical specification of the P200 and be chargeable by a Motorola multiple unit charger that accepts a Motorola battery pack. The radio's selectable frequencies shall include the frequencies indicated in Section 6-20.2, Existing RCS Frequencies.

6.20.7 Mobile Radios

Each LRV and designated automobile will be equipped with a 40-watt Motorola MaxTrac 300, or an approved equal mobile radio. An approved equal radio will be one that meets the technical specification for the MaxTrac 300 and, in the case of LRV equipment, has an emergency alarm identification unit and a silent alarm switch. The radio's selectable frequencies shall include the Operations Channels A, B, and C and the yard operations channel.

6.20.8 Operation Control Center

The OCC consists of operator consoles. A controller has the ability to operate any of the six radio communications frequencies from each console. Each console identifies the transmitter keyed and provides multiple indication of receiver signal vote selection.

6.21 Video Surveillance Systems

The project design, installation, testing and acceptance shall be approved and witnessed by MTS Security, IT, Safety and Risk Management departments.

The station VSS system components shall be compatible with the MTS existing VSS Avigilon equipment. The Contractor shall facilitate integration of the new station VSS equipment into the existing VSS equipment and coordinate with MTS personnel the design, implementation and testing details of the new equipment affecting the existing system.

The Video Surveillance System (VSS) should be designed for every day safety and security requirements as well as revenue protection, anti-graffiti, anti-crime and anti-terrorist applications requiring the identification of unknown people (i.e. facial recognition) and objects depicted within images (i.e. license plates). The VSS is used for video surveillance of the station platforms. At some stations, the VSS is also used for video surveillance of station indoors (station concourse), tunnels, station surrounding areas (i.e. station plaza, station elevators, parking lots, stairs and ramps, bus stops, etc.) and other facilities (e.g. Operations control center, maintenance yards, etc.). In addition, the VSS cameras can also be provided for coverage of location where money is intended to be exchanged (fare collection). The quantity and location of cameras will depend on the type and size of station.

All new VSS installations shall utilize Day/Night IP Cameras with a minimum of 5.0 MP or higher (depending on the locations only). Whenever is practical, the IP cameras shall be supplied dc power using Power-Over-Ethernet (POE) technology.

The station VSS cameras shall provide for 100 percent coverage for inside stations, station train platforms, tunnels, station elevators, pedestrian underpass, waiting areas and stairs/ramps. This coverage shall be achieved by use of Fixed IP Cameras.

The design of the fixed cameras (placement; elevation; camera tilt; and Vertical and Horizontal Fields of View) shall allow for following resolution:

- **Forensic Detail:** Priority targets (underpass, station platform, TVMs/PCIDs, parking exit/entrance, Stairs/Steps) require detailed coverage – at least 5.0MP camera or higher;
- **General Detail:** Remaining station areas – at least 5.0 MP camera.

The requirements to the VSS design for these areas of video surveillance shall be determined based on the priorities input from the MTS stakeholders, and MTS Security personnel.

Within the Station Communications Enclosure (cabinet, prefabricated building, or room) 19 inch rack shall reside an Avigilon Server that connects to the LAN 48 port switch (described in Section 6.5) and a dedicated un-routable video surveillance network switch with a 1.2 subnet. All cameras shall be connected to the un-routable network switch. Video images are recorded in the station Avigilon Server at the station.

At the stations, the VSS system shall utilize a dedicated station network video recorder (NVR), which is a high performance workstation for recording and storing of the station VSS video data. Station NVR shall utilize Avigilon Recorder Server VSS management and recording software. The station VSS PC hard-drives shall record and store video information up to 15 days for all station cameras, and at the highest resolution and frame rates allowed by the design of each implemented camera and the NVR (including 50% additional spare storage for future growth).

The Video Monitoring systems at the Operations Control Center (OCC) shall be able to: a) access and view selected cameras, and b) download selected video files. The network protocol shall be TCP/IP for all subsystems.

The VSS System design shall locally record video and allow MTS personnel at OCC to retrieve the video files via the WAN and LAN 48 port switch. Additionally, the system shall support requests for remote monitoring by independent agencies (i.e., Local Police Department having jurisdiction of where the system is located).

The network video system (VSS) shall be a fully digital system utilizing TCP/IP Ethernet protocols. A virtual LAN (VSS VLAN) shall be partitioned to dedicate bandwidth solely for the VSS subsystem. Network cameras shall be equipped to interface directly via single mode fiber, described in section 6, to the Station Communications Enclosure and un-routable network switch.

To accommodate current low bandwidth limitations for links between the VSS equipment at MTS OCC Communications Room and remote MTS stations, station's NVR shall support downscaling of the video streams to low resolution (i.e. 4 CIF) for remote "live" views. Note that downscaling will be used for a "live" view function only; the station NVR shall record video of the high resolution cameras at their maximum resolution and frame rate. To facilitate this function, station NVR shall utilize Avigilon Server software.

The station NVR shall support local and remote retrieval/download of recorded video.

For local retrieval, the station NVR shall support export of the recorded video into DVD or external hard drive media. The remote retrieval of the stored video (recorded at its full resolution and frame rate) over the low bandwidth leased lines and/or fiber line from the MTS facility is expected to be done during off-peak hours.

Such download shall be configured as a low priority function, which should not interfere with the performance of the remaining station subsystems.

All stored/retrieved video recording shall provide for evidence of authenticity (no video tampering took place), so that it could be submitted in the court of law as evidence,

As per the stakeholder input, for non-critical areas with the least amount of human traffic, use of motion and audio detection software is allowed, which could enable slowing down of the recording speed when there is no motion (e.g. during off or night hours) and speeding up the recording when motion is detected. This can be used to minimize the storage capacity requirements.

The network camera system shall deploy management software to automatically find and set up IP address, show connection status, and configure and manage firmware upgrades for multiple camera locations. To optimize bandwidth and image quality, the network camera system shall have a wide range of compression features, enabling the system to view events at H.264 and/or JPEG 2000 video compression while recording.

For enhanced security, network cameras shall be equipped with remote input and output ports for monitoring other security and alarm devices such as door contacts, smoke detectors and temperature sensors, light or other switches or alarm relays.

Activation of these I/O devices will cause the network camera to stream full video and generate activity reports.

Use of Megapixel IP cameras is encouraged for the majority of the station video surveillance applications. Megapixel images provide for the desired pixel-per-foot resolutions utilizing less cameras. As a result, even though Megapixel cameras are typically more expensive than traditional (4 CIF) cameras, however, they will more than compensate from the reduction of the number of cameras.

The designer shall produce storage design calculations showing that the capacity of video storage hard-drives is adequate. Note that typically such calculations include a variety of the various cameras types reflecting their specific frame rates, resolutions and compression types. The compression types and rates typically depend on a particular VSS Software Vendor and the designer shall provide the corresponding NVR storage requirement calculation as a part of their VSS design submittal. Also, to support future growth, the performance and storage of the station NVR equipment shall be rated to handle additional 50 percent of similar station VSS equipment.

As a part of the design submittals, the designer shall provide for MTS Engineering all necessary calculations for performance and storage requirements of the VSS system and identify adequate and up-to-date equipment/software fully compatible with the existing VSS Equipment in MTS OCC.

At minimum, the station design shall provide for RAID 5 or 6 redundancy for the station NVR hard-drives capable of recording and storing video information for 15 days (including additional 50 percent spare storage allocated for future needs).

The unroutable network switch at the station shall be partitioned for VSS as VSS Virtual Local Area Network (VSS VLAN). The designer shall produce calculations showing that allocated VSS VLAN bandwidth is sufficient to serve all station VSS System needs. This Virtual Local Area Network (VLAN) capability shall reside in the network switch hardware. Additional bandwidth shall be allocated depending on the station size and number of VSS camera locations.

6.22 Phone Service Provisions and Public Pay Phones

6.22.1 Payphone Services

SANDAG and the system operator will request that the San Diego Trolley pay phone service vendor furnish and install the pay phones at the station and provide a text telephone at stations forecast to have high ridership.

Provisions for these subsystems shall meet the requirements of specified herein.

Provisions for a minimum of one coin-operated telephone shall be provided at each station unless otherwise directed by the SANDAG Director of MM&PI and at least one location in the associated waiting areas stubbed for a phone.

Each pay phone location shall have two 1 inch conduits (one for communication the other for electrical) connecting the payphone location to the nearest set of communications and electric pull boxes. Each conduit at each payphone location shall have a threaded coupling set flush with the finish surface. Each coupling shall have a threaded plug installed in it.

Designer shall specify the installation of phone lines shall be placed from the phone company service point on the back board in the communications enclosure or room to the locations at which there are plans to initially install phones.

Public phones should be located near the waiting areas for use by patrons entering the system. A clear and level area 30 inches by 48 inches shall be provided at each pay phone for forward or side approach by a wheelchair. The designer shall specify half of the phones mounted with the highest operable part 48 inches above the floor (forward approach), and half of the phones mounted with the highest operable part 54 inches above the floor (side approach).

At least one phone location shall be equipped with a volume control and provide corresponding signage.

Subsystems shall be compliant with federal, state, and local laws such as the Americans with Disabilities Act (ADA) and applicable National Fire Prevention Association (NFPA) codes and standards relating to public transportation and communications systems. All telephones shall comply with the requirements of ADAAG, Sections 4.30, 4.31, & 10.3.1 (12) and Title 24, Part 2, Section 1117B.2.

If an interior public phone is provided in a transit facility, or if four or more are provided at a station entrance and one is interior, one public text telephone must be provided according ADAAG, Section 4.1.3(17)(c).

The Telephone Subsystem shall provide voice payphone services via the local telephone service provider. All communications devices, cables, protected terminals, and other interconnect equipment shall be grounded according to the phone service provider's and pay phone manufacturer's standards. Each communications enclosure or room shall identify space conforming to the minimum requirement of the utility phone service provider to able the phone service provider to install the phone service point of interface (POI).

6.22.2 Elevator Emergency Phone

Elevator emergency telephones shall be integrated into each elevator cab installed in stations to provide a direct means of emergency communications from a station patron, located inside the elevator, to the OCC. The design shall conform to ASME A17.1 latest edition, Safety Code for Elevators and Escalators, and ADA design guidelines.

The instrument shall be hands-free and have only a single push button to initiate an emergency call. The instrument shall not have a dial pad or a corded handset. The instrument shall be flush mounted and integrated into the elevator control panel. Each telephone shall be served by a local telephone service provider with no local parallel or 'party-line' wiring between instruments allowed.

6.22.3 Phone Company Interface

Design plans shall show the installation of phone service conduit from the point of interface (POI) shown on the backboard to the existing phone companies facilities to the station communications enclosure or room. The designer shall work closely with the SANDAG utility coordinator and the phone company's new service coordinators to identify the point of connection. Contract documents shall require conduit with pull rope be sized and installed in accordance with phone company standards and requirements.

Typically the phone company will require a dedicated, minimum 2-inch size conduit be provided from a telephone utility box/pole to the communications house/cabinet 0.75-inch plywood backboard for the utility company to bring in and terminate telephone company cable or other communications lines to the phone service backboard.

6.23 Electromagnetic Compatibility

Electromagnetic Compatibility (EMC) is the ability of equipment and systems to perform their intended functions within a transit system electromagnetic environment. The primary methods available for achieving electromagnetic compatibility are: shielding; grounding; balancing; filtering; isolation; separation; orientation; circuit impedance; level control; and cable design. The primary objective is to develop equipment and installation parameters that shall assure an electromagnetically compatible system. This objective shall be achieved through: Communications Systems equipment selection coordination; design; and installation.

The designer shall utilize design methods and practices that mitigate electromagnetic interference (EMI) and radio frequency interference (RFI) from sources commonly associated with a transit environment such as: traction power systems; the AC power distribution system; the vehicle propulsion system; the signaling system; and nearby electrical utilities. Designers shall design circuits so the location; routing; isolation; installation; grounding; and electrical circuit, wire, and cables shielding mitigates undesirable EMI and RFI generation and circuit coupling. Communications equipment shall meet FCC Regulatory Standards Part 15 for radiation and conduction. Shielded cabinets and line filters shall be utilized as required to meet these standards. Fiber optic cabling may be used where practical to eliminate electromagnetic interference.

6.24 Fixed Double Sided Information Signs

Double sided information sign frames typically contain printed material showing train schedule information, train route, and other information about the trolley system.

Each station shall have at least one double sided information sign frame per platform, typically located near the fare vending machines. Design plans shall show the location of the sign frames and reference the SANDAG standard sign frame drawing. Where non-standard sign frames need to be designed to accommodate specific station conditions, the designer shall provide a detailed design. To the extent feasible, non-standard frames shall be similar in design to standard sign frames in size and construction.

6.25 Transit Next Bus Messaging System (TNBMS)

MTS has certain routes equipped with a Next Bus Messaging System. Trolley stations designated transfer or transit centers or stations with dedicated bus bays within the station limits shall be designed with power and communications conduit from the Next Bus sign locations to a connection point for this system.

6.26 Interactive Kiosks

SANDAG may require station designers to locate and provide power and communications to interactive information kiosk positions on or near platforms. Kiosks would be specified and procured by SANDAG, and supplied to the installer. Except that SANDAG may specifically add the design and development the interactive kiosks in the design scope. Should design of the kiosk be added, SANDAG and the designer shall develop a basis of design for the kiosk prior to design and specification. For general location and clearance requirements, see Volume 1 – Transit Centers, “General Circulation and Access” Section. Interactive kiosks shall have two 1-inch Schedule 40 PVC conduits. One conduit shall be designed to connect to the local telephone service provider via the communications house/cabinet and the other shall connect to a power circuit dedicated for the kiosk from the station electrical panel.

6.27 Enclosed Stations within Structures

The following requirements only apply to enclosed stations within structures, such as buildings and tunnels.

6.27.1 Fire Detection Systems

The fire alarm systems shall be provided in enclosed station facilities located in buildings or tunnels. The fire detection sensors triggered by both heat and smoke detectors shall conform to all applicable federal, state and local requirements (including NFPA, State, and local Fire Marshall requirements).

The fire detection and emergency management panels shall be connected to the OCC via a dedicated WAN/LAN interface. All fire detection equipment shall conform to the latest requirements of NFPA Codes Section 12A, 72, 72-90 and 130.

6.27.2 Fire Alarms and Emergency Response and Management Systems

Fire alarms and Emergency Response and Management Systems shall be connected back to the Operations Control Center via dedicated redundant ring fiber optic strands solely used for Fire Alarm and Emergency Response and Management Systems. The Fire Alarm and Emergency Response and Management systems shall be designed in full conformance of NFPA and local responder requirements.

7.0 VEHICLES

7.1 General

This section describes the basic attributes of the light rail vehicles (LRVs) to be used by SANDAG/MTS. The vehicles shall be capable of full operation in either direction, be equipped with fully functional and identical operator cabs at each end, and be fully compatible with the existing vehicles for mixed consist (up to four LRVs) operation. Information contained herein is intended to generally define the composite aspects of the vehicle which relate to the interfaces between the vehicle and other portions of the light rail system.

The following LRV criteria shall apply with the understanding that changes will be forthcoming when the specific actual vehicle is defined.

At the publication of this document the fleet of LRVs included the following Siemens' models:

- U2 (Order SD1 – SD5) (Phasing Out);
- SD100 (SD6) Phasing Out);
- S70 Short (SD7);
- S70 Ultrashort (SD 8) (SD 70 US).

The designer shall confirm with SANDAG its current list of fleet LRV models in use.

7.2 Operations

7.2.1 Operating Hours

MTS plans to continue to operate 365 days a year, 22 hours a day.

7.2.2 Consists

Trains will operate in revenue service in consists of up to four cars in any combination of new cars, S70/S70, SD7, SD8, US vehicles and SD100 vehicles. Under normal conditions, vehicles will be coupled and uncoupled regularly in the yard, but they may be coupled on the right-of-way also. These new cars will not operate in consists with U2 light rail vehicles.

7.2.3 Signaling System and Train to Wayside Communications

Each vehicle shall be equipped with a Philips VETAG bi-directional VECOM Train-to-Wayside (TWC), or approved equivalent, communications system, fully compatible with the existing VECOM/VETAG II system.

MTS is using 60 and 100 Hz track circuits for track occupancy detection. Frequencies used for audio frequency overlays range from 200 Hz to 28 kHz.

7.2.4 Train Speed

MTS will operate train service at speeds reaching up to 80 km/h (50 mph) on the Blue and Orange Lines and 90 km/h (55 mph) for the Green Line and the Mid-Coast Corridor.

7.2.5 Annual Mileage

The expected annual mileage per vehicle is 100,000 miles.

7.3 Vehicle Design Constraints

7.3.1 Safety Requirements

Items, the failure of which could result in critical/catastrophic hazard, are designated “safety critical.” A critical/catastrophic hazard is a situation which could result in an injury or fatality to patrons or MTS personnel, or which could result in major damage to or a loss of a vehicle function or equipment.

Specific safety critical items identified for the vehicle are:

- Removing positive tractive effort during braking;
- Braking and safe braking distances;
- Prevention of initial motion with any brake applied;
- Fire-resistance requirements;
- Inhibiting motion when doors are open;
- Prevention of door opening during motion;
- Direction control.

The vehicle contractor shall identify any additional safety critical items incorporated in its proposed design.

7.3.2 Weight Criteria

Loading Definitions AW0 to AW4

As a baseline, a composite vehicle shall not weigh more than the following:

- Basis: 115 pounds (70.3 kilograms) per passenger;
- AW0: Empty Vehicle in running condition (Tare Load);
- AW1: Vehicle with all fixed seats occupied plus one operator (Seated Load);
- AW2: Vehicle with all fixed seats occupied plus one operator plus standees at 4 passengers/square meter (Design Load);
- AW3: Vehicle with all fixed seats occupied plus one operator plus standees at 6 passengers/square meter (Crush Load);
- AW4: Vehicle with all fixed seats occupied plus one operator plus standees at 8 passengers/square meter (Maximum Vehicle Structural Design Load).

The AW0 vehicle weight shall not exceed 97,500 pounds (44,225 kilograms)

7.3.2.1 Weight Distribution

- Design of the vehicle and arrangement of attached equipment shall be such that the following limits of weight variation and balance are maintained and shall be met with the vehicle standing on level, tangent track.
- The weight supported by the motored trucks shall be within 2 percent of each other at all car weights when referenced to the total weight on the motored trucks and even distribution of passenger load;
- Weight carried by the center truck shall be no less than 20 percent and no greater than 35 percent of the total vehicle weight under all load conditions and with even passenger distribution;
- Load on wheels on one side of any truck shall not differ by more than 2 percent from load on opposite side wheels for a vehicle weight of AW0 when referenced to the weight on that truck.

7.3.3 Vehicle Identification

Vehicles shall be sequentially numbered from the first production car to the last.

Table 7-1. – Vehicle Identification and Numbering

Cars 1001-1014	November 1980 (SD1)	Cars 1015-1024	November 1982 (SD2)
Cars 1025-1030	January 1986 (SD3)	Cars 1031-1050	November 1988 (SD4)
Cars 1051-1071	July 1989 (SD5)	Cars 2001-2052	October 1993 (SD6)
Cars 3001-3011	October 2004 (SD7)	Cars 4001-4065	2012-2013 (SD8)

7.3.4 Wayside Noise Control/Criteria

Sound pressure levels at the wayside shall not exceed the values shown below for the specified test condition on dry, level, tangent ballast and tie track.

Table 7-2. – Wayside Noise Control/Criteria

Condition	Average Noise Level
All auxiliaries operating simultaneously, including air conditioning, auxiliary power, and propulsion cooling system, with the car stationary.	72 dBA at 15.2 meters (50 feet) from track center line
Four-car train operating at any speed up to 40 mph, maximum acceleration or maximum full service brake, including dynamic brake cutout on all cars. Operation on newly ground rail.	78 dBA at 15.2 meters (50 feet) from track center line

7.3.5 Electrical Noise Control Requirements

Harmonic currents produced by the vehicle in the running rails shall not exceed 30 percent of the minimum guaranteed threshold of the associated signal circuits. Signal circuits shall have a fundamental frequency of 100 Hz. Audio frequency overlays shall also be used for at-grade crossing protection.

Electrical, electronic, and communications systems and sub-systems shall operate without either suffering or causing interference which may impact system operations and/or safety because of electromagnetic interference.

7.3.5.1 Radio Frequency Interference Limits

When measured at a distance of 30 meters (100 feet) and tested in accordance with MIL-STD-461, equipment shall not exceed the following interference limits:

- 109 dB over 1 microvolt/m/MHz at 150 kHz to 84 dB over 1 microvolt/m/MHz of bandwidth at 30 MHz (straight line semi-log);
- 58 dB over 1 microvolt/m/MHz of bandwidth at 30 MHz through 90 MHz;
- 68 dB over 1 microvolt/m/MHz of bandwidth at 90 MHz through 8 GHz.

7.3.5.2 Electromagnetic Interference

The light rail vehicle and all installed equipment shall not cause electromagnetic interference to the wayside signals or communications system of MTS, local railroads, or other communications systems.

The equipment supplied under this Contract shall not interfere with the VECOM/VETAG II Train to Wayside Communication system (TWC) in use throughout MTS's LRT system.

7.3.5.3 Conductive Emission Limits

- From zero Hz to 40 Hz, 10 A maximum;
- From 40 Hz to 120 Hz, 1 A maximum.

7.3.6 Smoke and Flammability Requirements

All materials and construction shall meet the requirements of the latest edited version of NFPA 130, Chapter 84, Vehicles, and related appendices.

The ceiling structural assembly shall meet a 30-minute minimum endurance rating when tested in accordance with ASTM E112. The floor structural assembly shall meet a 15-minute minimum endurance rating when tested in accordance with ASTM E112.

Total BTU content shall be no more than 90,000,000 BTU per vehicle. Heat release rate shall be no more than 45,000,000 BTU/hour per vehicle.

7.3.7 Provisions for Individuals with Disabilities

Provisions for individuals with disabilities shall be per the rules and regulations of the Americans with Disabilities Act (ADA) effective October 7, 1991, and shall comply with all applicable requirements for new transit facilities. Only the minimum requirements for design and construction are incorporated into the ADA Accessibility Guidelines. Related regulatory provisions of other government agencies having jurisdiction shall be used for additional guidelines in designing and constructing light rail vehicles to be free of architectural or other transportation barriers.

The latest editions of the code, regulation, and standard that are applicable at the time the design is initiated shall be used. If a new edition or amendment to a code, regulation or standard is issued before the design is completed, the design shall conform to the new requirements to the extent practical, except that it shall conform to the new requirements if required by the government agency enforcing the revised or new code, regulation, or standard.

SANDAG/MTS is committed to providing full accessibility for mobility impaired persons, particularly non-ambulatory persons in wheelchairs. Compliance with 49 CFR 38, subpart D, § 38.71 through § 38.87, inclusive, and any applicable portions of Title III of the Americans with Disabilities Act of 1990, U.S. Department of Justice, is required.

Accessibility for mobility impaired passengers shall be provided by means of automatically deployed and retracted bridge plates or approved equivalent devices. These ramps shall comply in structure, width, and slope with the requirements of 49 CFR 38 (ADA).

Reference:

- Federal Register 49 CFR Parts 27, 37 and 38, Transportation for Individuals with Disabilities, Final Rule
- U.S. Architectural and Transportation Barriers, Compliance Board, Technical Assistance Manual

7.4 Vehicle Clearances

For overall clearance requirements in regards to track alignment dealing with horizontal and vertical clearances, and curve clearances, see Section 3.1.

7.5 Vehicle Dimensions

For overall dimensions of the three LRV models listed above see the following figures:

- For U2 and SD100s (SD1-SD6) see Figure 7-1;
- For SD7 see Figure 7-2;
- For SD8 see Figure 7-3.

Figure 7-1. – U2 and SD100 Vehicle Dimensions

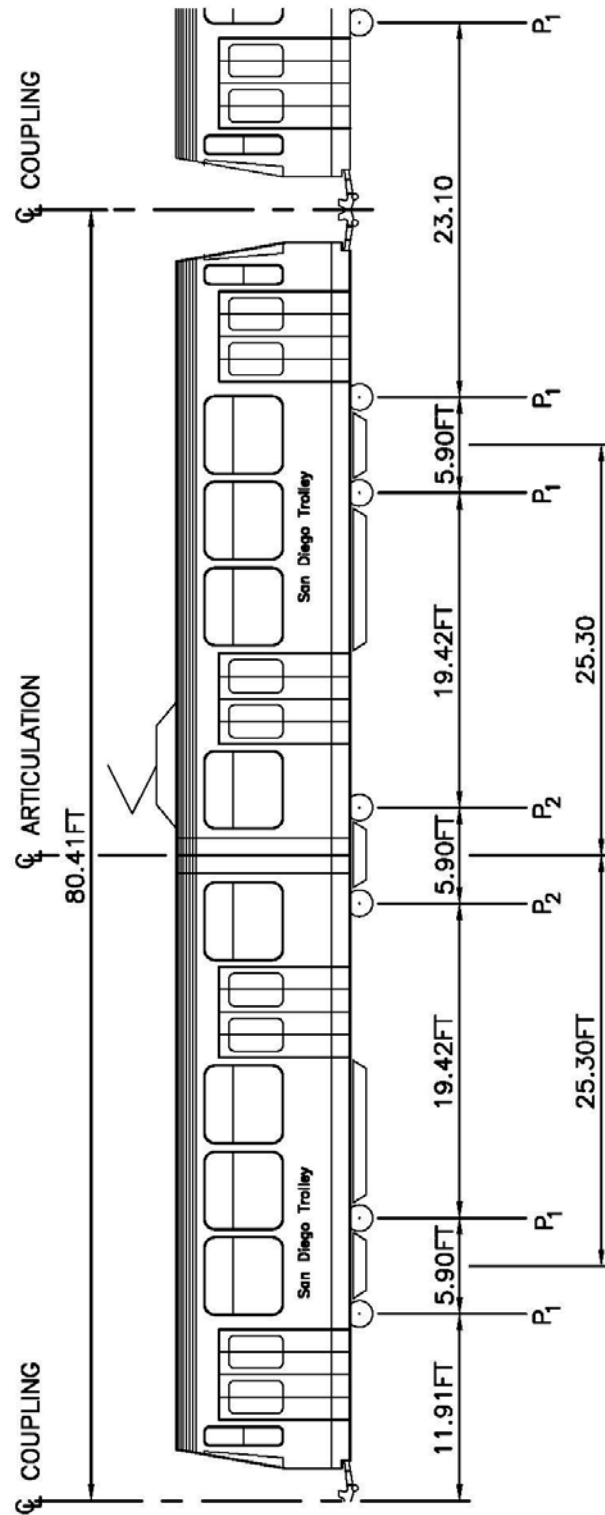

Figure 7-2. – SD7 Vehicle Dimensions

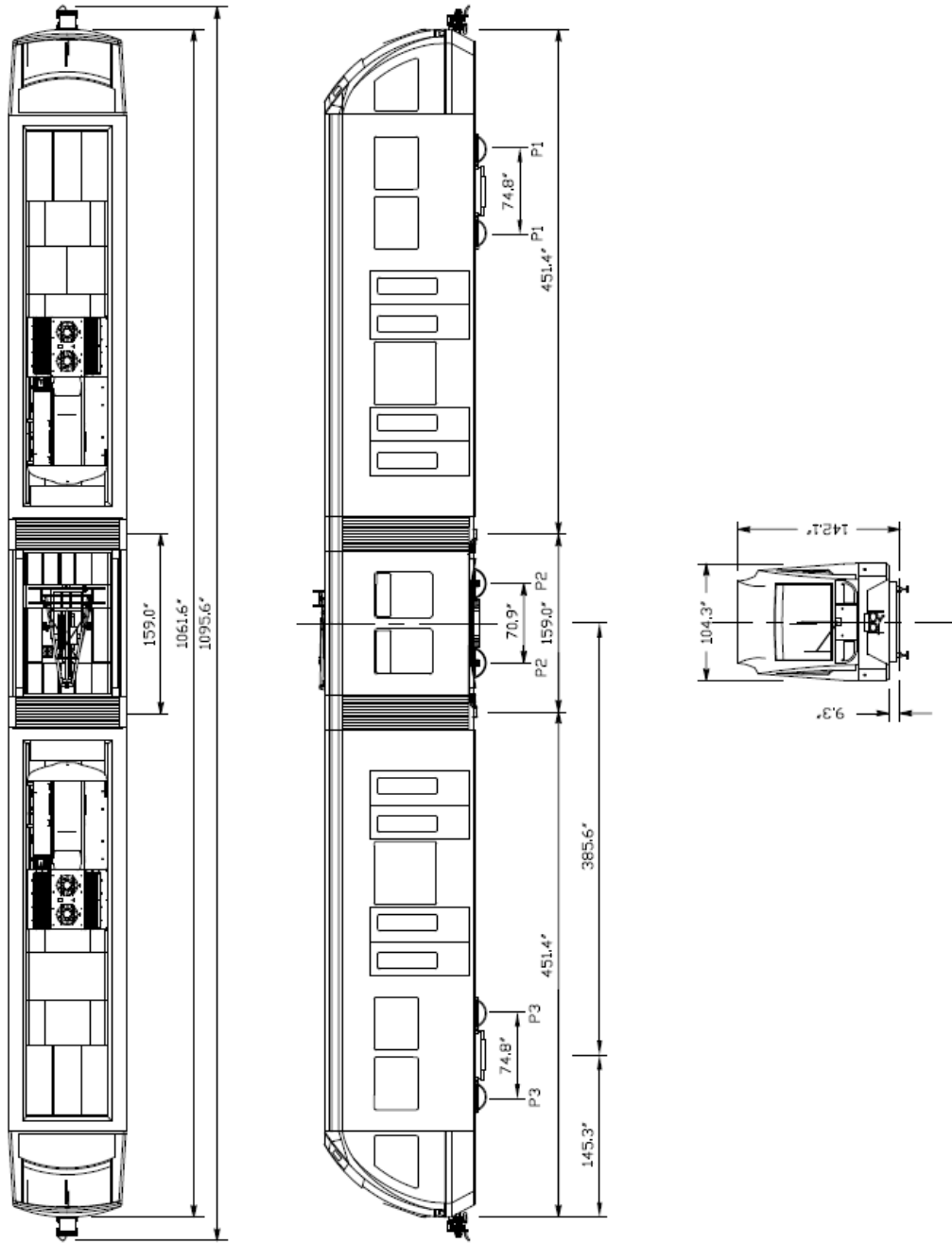
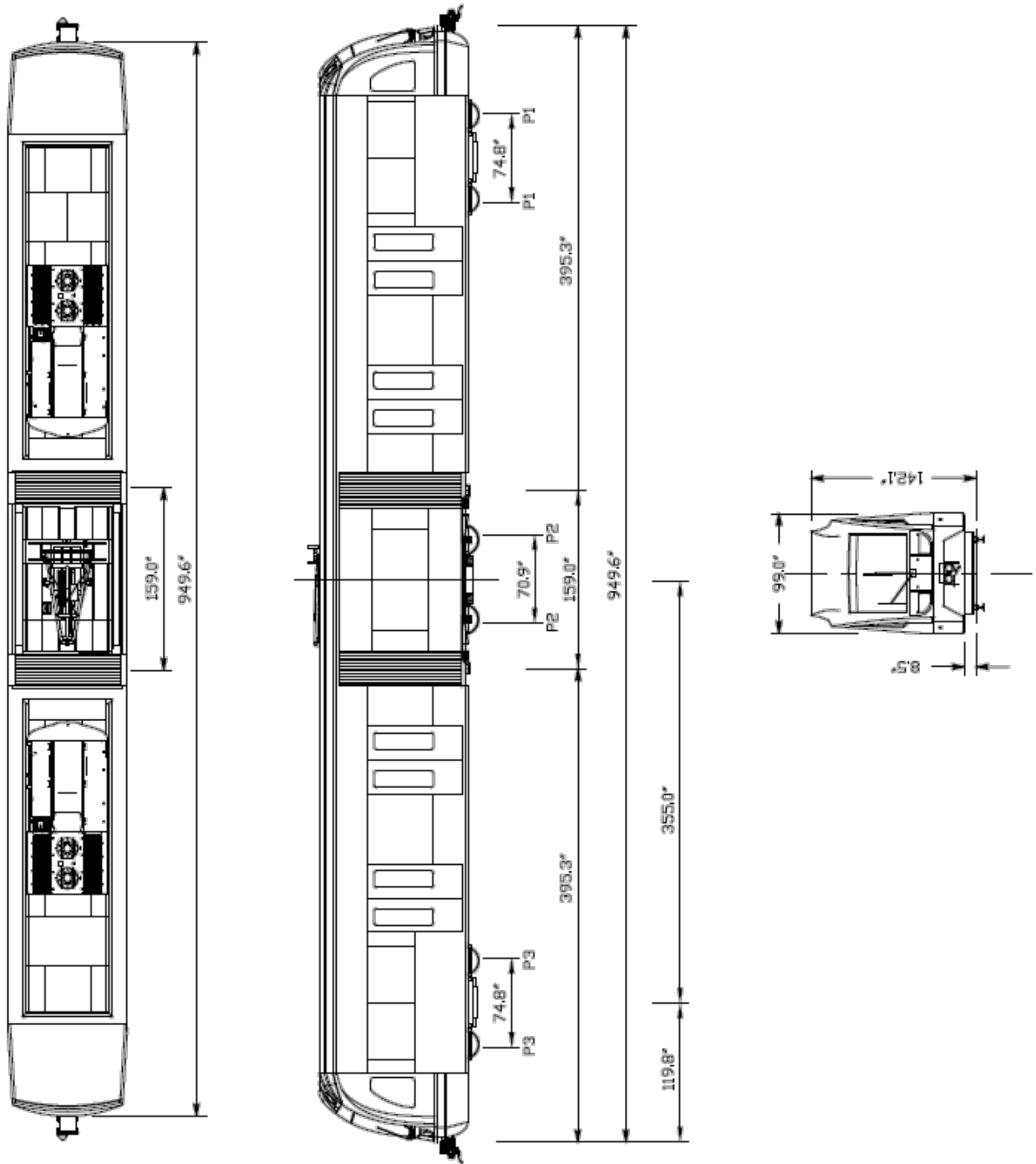

Figure 7-3. – SD8 Vehicle Dimensions



7.6 LRV Loading (lbs)

Loading for the U2 (SD1 through SD5) and SD100 (SD6) Models is as follows:

<u>Loading</u>	<u>Tare Wt.</u>	<u>No. of Operators</u>	<u>No of Pass.</u>	<u>Total Wt.</u>	<u>Axle Load P1</u>	<u>Axle Load P2</u>	<u>Axle Load P3</u>
AW0	84,176	0	0	84,176	16,034	10,021	NA
AW1	84,176	1	65	94,406	17,983	11,238	NA
AW2	84,176	1	145	106,806	20,346	12,714	NA
AW3	84,176	1	185	113,006	21,526	13,452	NA
AW4	84,176	1	225	119,206	22,707	14,190	NA

Loading for the S70 Short (SD7) Model is as follows:

<u>Loading</u>	<u>Tare Wt.</u>	<u>No of Operators</u>	<u>No. of Pass.</u>	<u>Total Wt.</u>	<u>Axle Load P1</u>	<u>Axle Load P2</u>	<u>Axle Load P3</u>
AW0	96,423	0	0	96,423	16,290	15,176	16,745
AW1	96,423	1	65	106,653	18,018	16,786	18,521
AW2	96,423	1	162	121,688	20,558	19,153	21,132
AW3	96,423	1	212	129,438	21,868	20,372	22,478
AW4	96,423	1	261	137,033	23,151	21,568	23,797

Loading for the S70 Ultra-short (SD8) Model is as follows:

<u>Loading</u>	<u>Tare Wt.</u>	<u>No. of Operators</u>	<u>No. of Pass.</u>	<u>Total Wt.</u>	<u>Axle Load P1</u>	<u>Axle Load P2</u>	<u>Axle Load P3</u>
AW0	96,132	0	0	96,132	19,226	9,614	19,226
AW1	96,132	1	61	105,742	21,149	10,573	21,149
AW2	96,132	1	147	119,072	23,814	11,907	23,814
AW3	96,132	1	190	125,737	25,147	12,574	25,147
AW4	96,132	1	233	132,402	26,480	13,241	26,480

Highest recorded SD8 as-built tare weight is 96,132 pounds. Loadings are calculated using a worst case weight distribution of only 20 percent on the trailer trucks (P2) with the remainder equally divided on the power trucks (P1 and P3) as allowed by the vehicle technical specification.

(Refer to Figures 7-1, 7-2 and 7-3 above for load axle points)

7.7 Electrical

Line Voltage:

Nominal	600 VDC
Range	385 – 780 VDC

SD 8 Operating Voltage:

Range	420 – 720 VDC
-------	---------------

Auxiliary Voltage:

Nominal	28 VDC
Range	±1.5 percent

A-C Power:

APS Inverter Output	460 Vac/3 phase
	120 Vac/single phase
Range	±10 percent

Propulsion Inverter Output:

550 Vac, phase
Variable Voltage
Variable Frequency

7.8 Vehicle Performance

LRV performance is defined for operations on dry level tangent track, AW2 loading for acceleration performance and AW3 loading for deceleration performance, over the specified range of wheel wear, with no significant wind. OCS voltage shall be at the nominal 750 Vdc for propulsion. In braking, the braking system shall perform as specified at any line voltage within the specified range.

Dry track conditions are defined as those conditions where the actual coefficient of adhesion is at least 25 percent without sanding.

7.8.1 Acceleration Requirements

All acceleration requirements shall be met for all car weights from AW0 to AW2.

The low-floor LRV shall be able to produce tractive effort for a full average acceleration rate of 0.44 m/s^2 (0.89 mphps) ± 5 percent from standstill to 88.5 km/h (55 mph) to a most accurate value matching the current average acceleration rate of the existing San Diego 7 and SD8 vehicles.

The maximum acceleration rate shall be of 1.14 m/s^2 (2.55 mphps) ± 5 percent.

The full initial acceleration rate may decrease linearly from AW2 to AW4 down to a value determined by the multiplication of the specified rate times the ratio of the AW2 weight to the AW4 weight.

Software adjustable parameters shall be provided to enable the specified tolerance to be obtained. During acceleration, the variations in instantaneous acceleration rate shall not exceed ± 0.045 meter per second squared (± 0.10 mphps).

An acceleration rate of no greater than 0.135 m/s^2 (0.3 mphps) shall be available to the operator at the minimum acceleration position of the master controller. This minimum rate requirement shall apply over a vehicle speed range from zero to at least 32 km/h (20 mph).

The time required to reach a vehicle speed of 80 km/h from standstill on level, tangent, dry track, with the vehicle loaded to AW2 conditions, shall not exceed 35 seconds.

The time required to cover a distance of 2,000 meters on level, tangent, dry track, from standstill, with the vehicle loaded to AW2 conditions, shall not exceed 113 seconds.

The time required to cover a distance of 2,000 meters on a uniform 2 percent up-grade, tangent, dry track, from standstill, with the vehicle loaded to AW2 conditions, shall not exceed 124 seconds.

The time required to cover a distance of 2,000 meters on a uniform 4 percent up-grade, tangent, dry track, from standstill, with the vehicle loaded to AW2 conditions, shall not exceed 142 seconds.

7.8.2 Speed Requirements

Maximum operating speed of 55 mph (90 km/h).

7.8.3 Deceleration Requirements

7.8.3.1 Service Brake

The service brake effort shall predominantly be produced by the dynamic brake system with friction brake support on the center truck blended in as needed at passenger loads higher than AW2.

All deceleration requirements shall be met for all speeds 88.5 km/h (55 mph) and for all car weights from AW0 to AW3. Brake effort ramp-up when initiating braking from maximum

speed shall replicate the equivalent characteristic of the existing SD100 (SD6) and short S70 (SD7) and ultra-short S70 (SD8) US vehicles when coupled.

The deceleration rate(s) shall be automatically adjusted to equal the performance of any existing SD100 (SD6) and short S70 (SD7)/S70 US vehicle it is coupled to, without the need for operator intervention. For friction brake, the variations in the average and instantaneous deceleration rate shall be ± 15 percent and ± 20 percent, respectively.

Operating as a single car or a pure LRV consist only, the LRV shall produce the maximum deceleration rate.

The fade-out speed of the dynamic brake system shall be 3 mph (4.8 km/h) with a smooth transition from dynamic to friction brake. The friction brake system shall provide the final stopping (and holding) force.

The average service brake deceleration rate shall be 1.34 m/s^2 (3 mphps).

The maximum deceleration rate shall be 1.4 m/s^2 (3.13 mphps).

A deceleration rate of no greater than 0.135 m/s^2 (0.3 mphps) shall be available to the operator at the master controller minimum brake position.

During deceleration, the variations in instantaneous deceleration rate shall not exceed ± 0.10 mphps between 88.5 km/h (55 mph) and 4.83 km/h (3 mph).

In the event of dynamic brake failure, the friction brake system (exclusive of magnetic track brakes) of an AW3 loaded vehicle shall be capable of executing one stop from 88.5 km/h (55 mph). This stop shall be a full service brake application with all dynamic brakes cut out.

The friction brake system shall be capable of sustaining an additional stop, (following the friction brake sequence in the immediately preceding paragraph, after maximum acceleration to maximum speed followed by immediate braking) without damage to the system or maximum disc temperature to be reached or exceeded.

The brake system shall then have the capacity to provide friction brake only deceleration rates with an empty car operating at the recommended (limited) top speed to the end of the line, making all station and safety stops and then be able to return to the maintenance facility making only the necessary safety stops without overheating the brakes.

The speed limit for operations with a failed dynamic brake system shall be recommended by the Contractor, but shall be no less than 40 km/h (25 mph).

The application of friction brake force shall be adjusted for slip control.

7.8.3.2 Emergency Brake

The commanded master controller emergency brake application shall use the combined effort of the magnetic track brakes, the sanding system, and the “blended” dynamic brake system (i.e., the primary use of the dynamic brake system on the power trucks and the friction brake system on the center truck).

The emergency brake force shall be corrected for slip-slide conditions to produce the shortest possible stopping distance.

The controls shall be interlocked to produce a retrievable stop.

Magnetic track brakes and sanding shall automatically cease 10 seconds after the vehicle is at “zero speed.”

Emergency brake rates shall be identical to those of MTS’s existing SD100 (SD6), short and S70 (SD7), and ultra-short /S70 (SD8) US vehicles, but in no case less than required by CPUC G.O. 143B, Section 4.

7.8.3.3 Parking Brake

The parking brake shall be capable of holding a vehicle loaded to AW4 on the steepest grade (7 percent) with a margin of safety of at least 20 percent.

7.8.4 Towing Requirements

A fully functioning train shall be capable, with no damage to its equipment, of towing various combinations of up to four dead vehicles at AW3, with up to four live vehicles at AW3 from any point in the LRT system to the next passenger station, and then continue at AW0 to the nearest end of the line at reduced performance. An inoperative train is defined as a dead train. Due to the reduced adhesive weight, the acceleration rate can be reduced to the limits required to operate in accordance with the track characteristics. The deceleration rate can also be reduced, but not to be less than the safe braking rate. Under slippery track conditions, sanding may be used to make the actual adhesion at least equal to the adhesion required by either the positive tractive force during the propulsion mode, or the negative tractive force during the braking mode.

7.8.5 Jerk Limit

Under all normal operating conditions, the rate of change of vehicle acceleration or deceleration shall be limited to 1.34 m/s^3 (3 mphpsps) ± 10 percent.

Rate change requests less than the jerk limit shall follow the command signal within required accuracy limits.

The jerk rate limit specified shall apply to all normal power and service braking applications and not be exceeded due to reapplications of power and braking when controlled by the spin/slide system.

Release of power when traversing overhead primary power isolation gaps need not be jerk limited; however, reapplication of power must be jerk limited.

Emergency brake applications and track brake applications shall not be jerk limited.

7.8.6 Wheel Slip/Slide Protection

A system shall be provided to detect and control wheel spin and slide on each car, on a per truck basis, whether random or synchronous. The spin/slide protection system shall be

designed for fail-safe operation such that a spin/slide system failure must not prevent the application of braking at any level demanded.

The efficiency of the spin/slide system shall be at least 75 percent on a slippery track with an adhesion coefficient of 10 percent, when operating with friction brake only in either service braking or emergency braking.

The spin/slide protection system shall be functional under all acceleration and all dynamic and friction braking commands except Panic Brake. Failure of any component in the spin/slide system shall not, after an allowance of 3 seconds for failure detection, reduce the brake effort.

The spin/slide protection system shall operate to minimize wheel spin and damage to wheels from sliding, consistent with minimizing stopping distance.

The spin/slide system shall monitor all axle or wheel speeds and shall detect slides or spins by evaluation of axle/wheel speed differences and acceleration/deceleration rate levels.

7.8.7 Load Weight System

A load measuring system shall be provided to produce real time signals proportional to the car loading (AW0 to AW43) for both the propulsion (including dynamic braking) and friction braking systems (except track braking). Accuracy of the load measuring system shall allow compliance with car acceleration and braking requirements indicated above. The load calculation basis shall be motor torque and vehicle acceleration.

Failure of the load weighing system shall not result in acceleration or braking tractive efforts less than provided for a minimum car weight nor greater than provided for a maximum car weight.

7.8.8 Mode Change Dead Times

Mode change dead times shall be as follows:

- Power to brake mode change times not to exceed 500 ms;
- Brake to power mode change time not to exceed 600 ms;
- Total mode change time for power to coast plus coast to brake not to exceed 500 ms;
- Mode change time for brake to coast plus coast to power not to exceed 600 ms.

The dead time in command transitions from coast to either dynamic brake or power shall not exceed 250 ms, from the generation of the new command signal. These times shall be measured from the last (minimum) measurable point of the former variable to 10 percent of the final value of the latter variable.

All measurements shall be of system outputs such as current or braking effort and not vehicle acceleration or deceleration. These times do not include operator reaction time. Propulsion and brake software shall allow adjustments to dead times in order to better match the existing fleets of SD100 (SD6), short S70 (SD7), and ultra-short /S70 (SD8) US vehicles.

7.9 Car Body

The car body shall be constructed of low alloy high tensile (LAHT) steel. All exterior surfaces of the LAHT steel shall be primed and painted. All interior metal surfaces shall be coated with a primer for corrosion protection. Vehicle end caps may be fabricated using molded fiberglass.

7.9.1 Strength Requirements

The yield strength of all structural members shall withstand a uniform vertical load of AW3 minus AW0 with at least a 50 percent margin.

The vehicle shall withstand a static compression end load of two times AW0 acting along the longitudinal centerline of the vehicle and distributed at about the center of the anticlimber.

The combined stresses from the above vertical load and the above static compression end load shall not cause any deformation in any part of the car body and shall not exceed 90 percent of the yield value of the material used. Each anticlimber shall have at least three ribs.

7.9.2 Roof

The roof sheathing and structure shall be capable of supporting without any permanent deformation concentrated loads of at least 73 kg (250 lbs.), as would be applied by a person walking on the roof. Areas adjacent to the pantograph shall support concentrated loads of at least 227 kg (500 lbs.s.).

A roof mat shall be installed on the roof to provide an anti-slip walking surface. In addition, an electrically insulated area on the roof, under and around the pantograph mounting, shall be installed to provide a safe working area for maintenance personnel.

7.9.3 Jacking and Hoisting Provisions

The vehicle shall be equipped with jacking and hoisting provisions. The vehicle may be jacked as a unit. Each body section may be jacked separately, with the body bending at the articulation section(s). The maximum angle of bending of the articulation shall not exceed 3 degrees. Any combination of diagonal jacking shall not cause any structural or cosmetic damage.

Jacking pads shall be provided for:

- Portable jacks;
- In-floor hoists;
- The articulation.

Jacking at the anti-climber positions shall be permitted. The vehicle design shall include provisions for re-railing the center truck.

7.9.4 Wheelchair Accommodations

Provisions shall be made to comply with the latest ADA requirements.

7.10 Couplers and Draft Gear

7.10.1 Mechanical Couplers

Couplers shall automatically couple on contact within a gathering range of 76 mm (3 in) and with a maximum of 8 degrees of total rotational mismatch. Couplers shall withstand AWO car coupling at speeds up to 4.8 km/h (3 mph) without automatic release or damage.

The coupler system shall withstand a buff or draft load of 79.38 metric tons (175,003 lbs.) with no permanent deformation.

7.10.2 Draft Gears

At buff or draft loads above 68.04 metric tons (150,003 pounds), draft gears shall collapse to allow the anticlimbers to meet while absorbing the moment resulting from the load.

7.10.3 Electrical Couplers

Spring-loaded silver-plated contacts, which are redundant on each side of the coupler, shall carry all necessary electrical signals from car to car. Electrical couplers shall use a mirror image configuration such that any end of any car can be coupled to any end of any other car.

Electrical coupler heads shall be protected by weatherproof covers, which shall automatically swing clear when a coupling is initiated.

7.11 Operator's Cab

There shall be two completely functional operator's cabs per car. Trainline control shall permit only one cab to act as the active controlling cab in a train-consist.

The operator's cab shall be of a design based on appropriate human factors. The operator's cab dimensions shall ensure safe and optimal operator performance for operators in the range of the 5th to 95th percentile of the general population, both female and male.

7.11.1 Operator's Console

The operator's console shall contain all controls and annunciators to safely operate the train.

7.11.2 Bypass and Cutout Switches

One panel within each operator's cab shall contain sealed safety bypass switches that shall permit manual operation of the train in the event of failure of major subsystems. An adequate annunciation shall be provided to clearly indicate to the operator which bypass switch is in a bypass position.

7.12 Passenger Doors

There shall be four passenger doors per side in each car. Door operators shall be electrically operated. The door opening function shall be interlocked with the propulsion and brake systems, such that motion is not permitted when any door in a train consist is not fully closed, and such that brakes are applied when the door opening function is enabled by the operator or any door in a train consist is not fully closed.

7.12.1 Normal Operation

Doors shall normally be opened individually by passenger-operated push-buttons, after release (enable function) by the train operator after the train stops at a station. The operator shall normally control the closing of the doors. In addition, the operator shall have the capability of controlling opening and closing of the doors on either side of the train.

7.12.2 Emergency Operation

An emergency manual door release shall be provided near each door.

Activation of the emergency door release device shall unlock the door for manual opening, prevent motion, and place the train in an irretrievable full service brake application. In addition, any attempt to activate an emergency door release device in motion shall reapply closing power to the door at that location in order to prevent its manual opening.

7.13 Air Comfort System

The air comfort system shall include heating, ventilating, and air conditioning to assure passenger comfort in the operating environment. The air comfort system shall be equipped with a single control unit. Maximum interior relative humidity shall not exceed 55 percent.

Except in layover mode where the ventilation shall not be used, ventilation shall be provided all the time to ensure that a minimum comfortable amount of fresh air is delivered to the vehicle.

The heating system shall include overhead and floor heaters in the passenger compartment, and cab heaters in the operator's cabs. The heating system shall be designed to maintain the interior temperature around 20 degrees C (68 degrees F). The heating system shall also be provided with a "layover" mode. In the layover mode, a selected number of floor heaters shall be used to maintain the interior temperature around 13 degrees C (55 degrees F). In the layover mode, the car interior temperature shall be controlled by a separate layover thermostat. Heated surfaces which may come in contact with passengers shall not exceed 51.7 degrees C (125 degrees F). With an exterior ambient temperature of 23 degrees C (73 degrees F) to 35 degrees C (95 degrees F), the air conditioning system shall maintain the vehicle interior temperature between 23 degrees C (73 degrees F) and 26 degrees C (78 degrees F). With exterior temperatures above 35 degrees C (95 degrees F), the vehicle interior temperature shall be at least 9 degrees C (48 degrees F) lower than the outside temperature. The air conditioning units shall be mounted on the vehicle roof and may be individually controlled by the single air comfort control unit.

7.14 Lighting System

The lighting system includes all interior and exterior lights, with the exception of annunciator lights. LED lighting shall be provided for all interior and cab applications and where commercially available, for all exterior applications.

7.14.1 Interior Lighting

The passenger compartment shall be lit by continuous fluorescent lighting fixtures, which shall not extend into the operator's cabs. The operator's cabs shall be lit by separately controlled lamps.

7.14.2 Exterior Lighting

All exterior lights shall be trainlined for proper illumination and identification at night.

The vehicle shall be equipped with three headlights, two taillights and three stoplights at each end. The center headlight shall be a 200-watt PAR 56 or equivalent railroad lamp. The stoplights shall operate at approximately 150 percent of the intensity of the taillights.

For joint freight/LRV operation, exterior lighting shall be in compliance with the requirements agreed upon between SANDAG and FRA.

7.14.3 Emergency Lighting

The emergency lights shall be all exterior lights, all cab lights, all lights above the doors, and 25 percent of the interior lights. The emergency lights shall remain functional for at least 60 minutes in the event of a failure of the auxiliary power supply using battery power back-up.

7.15 Auxiliary Electrical Equipment

7.15.1 Power Collection

Power from the overhead contact system shall be collected by a roof-mounted pantograph which uses a double shoe arrangement of proven service design. The double shoe arrangement shall include a spring loaded suspension. A lateral load of 65 pounds (29.50 kg) on the pantograph shoe axis with the pantograph at the maximum operating height shall not cause the shoe to deflect more than 1.5 inches (38 mm). The pantograph shall be mounted as close as possible from the center of the vehicle to minimize lateral movement under all track conditions. A breakaway design shall be used so that the pantograph is sacrificial to the overhead wire in case of snagging.

The pantograph shall be raised by a spring, with an appropriate damping device to minimize bouncing.

The upward contact force shall be approximately 7.25 kilograms (16 pounds). The pantograph shall be electrically lowered and latched. An electrically released lock-down mechanism shall be provided to prevent movement of a locked pantograph.

Means shall be provided to manually release the lock-down mechanism, and raise, lower, and latch the pantograph from inside the vehicle if electrical power is not available. The pantograph design shall include provisions for clearing ice from the OCS. The pantograph may be unpowered while clearing ice.

7.15.2 Auxiliary Power Supply

A variable duty cycle static inverter shall be provided to develop 3 phase 60 Hz 208/120 V auxiliary power from the 750 Vdc primary power supply. The voltage regulation shall be within

± 5 percent, and the frequency shall be maintained within ± 5 Hz. Alternatively, the voltage-to-frequency ratio should be maintained within ± 1 percent at all loads. Capacity shall be sized to handle worst case loads for any season or operating conditions with an additional 10 percent margin.

7.15.3 Low-Voltage DC Power Supply

A nominal 37.5 Vdc low-voltage power supply (LVPS) shall be provided to power systems and subsystems controls, exterior lighting and annunciators, and door operators. In addition, the LVPS shall also maintain the storage battery charge. Output of the LVPS shall be regulated within ± 10 percent from zero to full load.

7.15.4 Storage Battery

A nominal 28.5 Vdc, nickel-cadmium battery shall be provided to initially start the vehicle and to power emergency loads during failures of the LVPS or when the primary 750 Vdc power is lost. The capacity shall be sufficient to power emergency loads for at least 1 hour of operation.

7.15.5 Emergency Loads

Emergency loads are defined as follows:

- Emergency lighting;
- Door control and drives for five cycles;
- Communications and signaling equipment;
- Propulsion and braking controls (including hydraulic pumps);
- Trainline controls;
- Track brakes during five emergency stops from 55 mph;
- Pantograph control for three down/up cycles of the pantograph;
- Coupler control for three couple/uncouple operations;
- Operator's console indicators, cab lighting, controls, annunciators, and interlocks;

Warning devices for five operations.

8.0 LRV MAINTENANCE FACILITIES

8.1 General

SANDAG/MTS has existing maintenance facilities including yard and maintenance. However, it was determined that a design criteria should be established for potential future application or where improvements to existing facilities were necessitated. Therefore the criteria established in this section are for application to design of new facilities or extensive non-maintenance improvements to existing facilities only.

8.2 Design Codes and Standards

This entire section deals with design of structures, surfaces, infrastructure, and track and their associated components. Structural codes are listed below; however all track related design shall be in accordance with the codes and standards as provided in Chapter 3, Trackwork.

8.2.1 Building Code

Design requirements for maintenance buildings shall comply with the most current edition of the following:

- California Uniform Building Code (UBC);
- Uniform Mechanical Code (UMC);
- National Electrical Code (NEC);
- National Electrical Safety Code;
- Uniform Plumbing Code;
- National Fire Protection Association (NFPA);
- American National Standard Code for Elevators;
- American National Standards Institute, Inc. (ANSI);
- Americans with Disabilities Act;
- All applicable local codes and standards.

8.2.2 Permitting

As a State chartered agency SANDAG/MTS is exempt from obtaining local building permits. This does not exempt SANDAG/MTS from conforming to applicable codes or inspection of facilities by properly certified inspectors. It is SANDAG/MTS's basic policy for building construction to conform to established codes and standards regardless of any exemption that may apply. As with codes, required or desirable permits should be identified as early as possible in the design process, preferably in the Basis of Design for the facility. However, the designer should be prepared to develop a submittal package to all permitting agencies should the request be made at SANDAG/MTS's discretion.

8.3 Basic Design Process

8.3.1 Basis of Design Statement

The basis of design shall cover all aspects dealing with the planning of yard and maintenance layouts. Thorough consideration must be given to requirements concerning all aspects of maintenance and operations being utilized within the yard and maintenance facilities, including the following:

- Maintenance and repair;
- System central control;
- Yard and facility control;
- Storage;
- Security;
- Personnel.

8.4 Yard and Shop Facilities

Yard and shop facilities primarily serve the following functions:

- Storage for revenue vehicles, maintenance equipment and supplies;
- Inspection, service and maintenance of revenue vehicles;
- Repair of components removed from revenue vehicles;
- Operator reporting and dispatch;
- Miscellaneous maintenance and support services.

8.4.1 Daily Service

Daily service tasks are generally performed at night and include:

- Visual inspection of the running gear, lights and car body;
- Interior cleaning;
- Exterior cleaning.

8.4.2 Running Repair

Running repair tasks generally require less than one shift (8 hours) to complete and do not require lifting of heavy components. Running repair may be performed on a three-shift schedule. Running repair tasks would include:

- Minor repairs;
- Scheduled inspections;

- Component change out;
- Lubrication;
- Testing.

8.4.3 Heavy Repair

Heavy repair tasks are generally major repairs and overhauls, scheduled inspections and component change-outs that require more than one shift or require the use of vehicle hoists, cranes or other special machine tools to complete.

8.4.4 Yard Operations

Maximum flexibility is to be provided. Direct access from the mainline to the storage tracks is desirable. A run-around bypass track separate from the makeup and storage tracks is desirable for nightly servicing and movement of LRV's into and out of the shop.

8.4.5 Yard Layout

Basic guidelines for developing the yard layout are as follows:

- Direct access from the mainline to the storage tracks is required;
- A yard run-around track separate from make-up and storage tracks is desirable for nightly service, and access to shop tracks;
- Double ended storage tracks are desirable for maximum flexibility and to reduce revenue movements;
- A double throat lead track from the mainline to the storage yard is desirable because the simultaneous receiving and dispatching of trains is possible. Complete blockage of the throat during a turnout failure is eliminated;
- Minimum radius on yard tracks is 100 feet (car minimum turning radius is 82 feet);
- Loop track is desirable for maximum operational flexibility;
- Storage tracks shall be constructed to allow sufficient space for maintenance operations;
- Storage tracks shall ideally be sized to accommodate six light rail vehicles (common denominator for 2 and 3-car consists);
- Paved service aisles between storage tracks;
- Parking for personnel as close as possible to work areas in controlled areas;
- Space shall be provided as necessary for storage of miscellaneous materials and equipment;
- Yard lighting adequate for operations to be performed safely;
- Access roads to servicing yard and service aisles;
- Life safety requirement for emergency vehicle access to storage yard.

8.4.6 Lighting

All exterior lights shall meet external use requirements and be equipped with photo sensor control switches.

8.4.6.1 Building Lighting

The transit system is a 24-hour per day operation. Therefore adequate lighting is essential for night time operations. Interior lighting for the buildings shall be in conformance with state building codes. Fluorescent or LED lights to be used inside. Exterior lighting shall provide sufficient illumination for safety of personnel and visual perception of security cameras. Entrance and exit gates and building access points shall be adequately illuminated to allow clear sight of security mechanisms such as card readers and/or key pads.

8.4.6.2 Vehicle Storage Lighting

Lighting shall be sufficient to cover all areas of vehicle storage with the minimal amount of light standards in accordance with the illumination plan. Lighting shall be of the high intensity discharge (HID) type. The main lighting for the vehicle storage shall be by high mast lighting standards 80 ft. or higher equipped with a multiple high bay light fixture luminaire ring and power cable connection for raising and lower of the luminaire ring during maintenance.

8.4.6.3 Illumination Plan

An illumination plan shall be submitted prior to the start of final design showing source locations and probable illumination levels in the field of areas to be lighted. This plan shall be the basis for completing the lighting design plans. Lighting design plans shall be overlaid with civil, structural, and utility plans and all conflicts shall be resolved.

8.5 Vehicle Storage

The yard shall provide for storage of the LRV fleet.

8.5.1 General

The storage layout should efficiently provide for enough space to accommodate all vehicles plus sufficient room for maneuverability, and all building locations with room for expansion. Storage circulation shall provide for easy movement of vehicles through ingress and egress points from active guideways, and to and from the storage to the maintenance building minimizing reverse movements. It is desired to have more than one connection from active guideways to the storage area.

Vehicle service, maintenance, and storage areas shall be secured by 10 feet high minimum perimeter fencing. Fence locations shall be subject to all clearance requirements indicated in Chapter 3, Trackwork.

8.5.2 Storage Capacity

Storage capacity shall be consistent with SANDAG/MTS requirements for future expansion. Layout of storage area should be as uniform as possible providing ease of access by personnel and clear view of all vehicles from the control tower.

8.5.3 Parking and Service Roads

Parking shall be evaluated and located based on concentration of work force and accessibility needs. In facilities housing high concentrations of personnel parking shall be located adjacent to or in close proximity to the facility depending on accessibility and clearance requirements.

Service road layout shall be in coordination with SANDAG/MTS. Designer shall consider the following:

- Accessibility requirements;
- Safety;
- Clearances;
- Line of sight for driver.

Service lanes shall be clearly delineated. In addition, signage shall be provided specifically in areas where service roads cross mainline track or highly active track.

Fire lanes shall also be incorporated into service lane layout and be reviewed and approved by the City Fire Marshall.

8.6 Maintenance

8.6.1 General

The purpose of the maintenance facilities is to provide essential space, machinery and services to accomplish required maintenance for transit vehicles, wayside equipment, components and electronic equipment. Assignment of maintenance is spread among two areas: one major repair and one inspection preventive maintenance and general repairs. The allotment of work is based on the relative shop sizes, personnel, equipment, degree of complexity, and availability of vehicles for scheduled service.

Maintenance shall include all structures and facilities required for maintaining and operating the vehicles and the system. Basic facilities required shall include the following:

- Maintenance and repair shop;
- Paint booth;
- Central control;
- Operational offices.

Architectural elements such as colors, fabrics, finishes, textures, and furniture shall be covered under secondary design submittals and shall be as approved by SANDAG/MTS.

In addition, all civil, mechanical, structural, and electrical design shall be included in the design and shall be in accordance with all applicable codes, standards, and regulations.

8.6.2 Vehicle Maintenance

8.6.2.1 General Criteria

General criteria for the vehicle maintenance facility layout shall be as follows:

- Proximity to active guideways and storage area to minimize movements and accelerate emergency repairs;
- Run-through tracks, for LRTs, and pass-through bays, for buses, in the building area to provide efficient flow of vehicles;
- Grouping related maintenance and cleaning activities to simplify supervision and work flow;
- Space for one vehicle on apron adjacent to each shop bay;
- Internal shop circulation and proximity of support activities;
- Adequacy and type of heavy lifting equipment, and its relationship to vehicle service;
- Requirements for special component handling equipment, such as transfer turntables which require excessive space;
- Layout and sizes of material storage areas;
- Shop operating and work scheduling procedures;
- The tasks of the shop are oriented toward the repair of vehicles and, as such, repair shops shall be designed to service individual vehicles;

The following general requirements have been established for the service shop. These requirements shall be reviewed and expanded as required by SANDAG/MTS:

- Complete vehicle overhaul including all body and propulsion repairs;
- Pantograph platform to service, remove or replace car pantograph;
- Exchange of trucks or bodies;
- Extensive modifications;
- Minor repair of miscellaneous system equipment;
- New vehicle acceptance and preparation;
- Preventive maintenance;

Support areas for the vehicle maintenance facility shall include the following:

- General shop work area;
- Areas for various minor welding, sheet metal, grinding and sanding, and small parts painting;
- Spare parts storage;
- Battery room;
- Truck assembly stand;
- Wheel truing;
- Wheel and axle service area;
- Tire storage and service area;
- Motor/engine repair;
- Electronic repairs;
- Foreman /Shop Supervisor facilities – general work areas, and receiving and shipping including loading docks.

8.6.3 Machinery and Equipment

There are many different types of machinery and equipment available for consideration in the design of a maintenance facility. In general, it is recommended that the selection of the machinery and equipment to be installed be based on:

- Satisfying the operation and maintenance requirements and policies of the facility;
- Reducing overall operating cost and particularly manpower requirements.

8.6.4 Vehicle Cleaning Area

Interior car cleaning is done in the storage track area for LRVs.

8.6.4.1 Daily Interior Cleaning

Cars which have been in revenue service require inside cleaning or sweeping daily. Trash shall be removed, light stains or spills cleaned, and graffiti shall be removed using non-toxic and non-flammable materials whenever possible. These functions shall be performed in the storage yard or at a designated location on the wash or sanding track.

8.6.4.2 Heavy Interior Cleaning

Heavy cleaning shall be accomplished as the car is scheduled for shop inspections. A servicing platform is required for these purposes. The servicing platform shall consist of a cleaning bay with step level platforms along both sides. A portable wet vacuuming system is desirable for ease of washing the floors, walls and mats on the vehicle.

8.6.4.3 Exterior Vehicle Wash

An automated drive-thru vehicle wash system shall be provided for vehicles coming off the active guideways into the storage area. Layout of the wash facility shall allow for easy access for supply and service vehicles and personnel maintaining the facility.

The wash facilities shall provide for the following basic elements unless otherwise directed by the Project Manager:

- Protective siding;
- Use of recycled wash water;
- Spot-free rinse;
- Blower system;
- Concrete running surface through wash facility and, at a minimum, four car lengths beyond the exit side;
- An LRV exit route;
- Drip pads along the track that lead to car wash end drains;
- Discharge system inclusive of Oil/Water Separator;
- Barrier separation, with cover, of wash equipment from operating wash area;
- LRT – The vehicle wash should be located far enough off of the mainline to allow a four car train to queue up and not interfere with the mainline and allow for additional trains to still enter the yard.

Configuration of Work Area

- Support the requirements of the washer;
- Area between wash and rinse shall be equipped with vehicle step height platforms to provide an area to perform heavy interior cleaning and daily cleaning;
- Area between wash and rinse shall contain a pit between the rails to allow underbody steam cleaning.

Utility Requirements

- Support the requirements of the washer;
- Overhead lighting;
- 230 V single phase and 480 V three phase receptacles;
- Recycle equipment to meet local codes;
- 720 V DC catenary through the building;
- Area floor drainage;
- Hose bibs;

- Compressed air;
- Pit lighting.

Special Equipment

- Package train washer complete with all recycle and chemical equipment;
- Steam generator.

Design Requirements

- Locate on a through track with good access to storage yard;
- Sanding operation may be on same track as train washer, but not in the wash and rinse areas;
- Isolation of electrical systems.

8.6.5 Maintenance Inspection

At scheduled intervals, each vehicle shall receive a thorough inspection of all systems. Inspection bays shall be provided to handle inspections. The inspection bays can also be used for minor repair work on the control, brake, and other systems.

Pits shall allow inspection of trucks, couplings, draft gear and equipment under the car; portable steps shall allow good access to equipment boxes and-car steps under the side of the car; moveable platforms shall be provided for access into the cars from the pit, and high level platforms are positioned for pantograph inspections.

8.6.5.1 Configuration of Floor and Workspace

- Rail mounted on pedestals;
- Continuous pits 5 feet deep with utility services listed below;
- Pantograph inspection and vehicle roof access platforms;
- Vehicle floor/step entry level platforms;
- Ramps or material lift and steps from rail level aisles to pit floor.

8.6.5.2 Utility Requirements

- Compressed air;
- Area floor drainage;
- Area overhead lighting to provide 35 to 45 foot-candles, at all work locations;
- Pit and platform lighting;
- 230 V single phase and 480 V three phase receptacles available at all work levels;
- Catenary through the building w/isolation switches and status indicators;

- 720 V DC power and portable cable;
- Extra large high pressure hose bib for shop housekeeping.

8.6.5.3 Special Equipment

- Eye wash (throw away type recommended);
- Portable step platforms;
- Automated wheel measure device in yard entrances.

8.6.5.4 Design Requirements

- Should be on through tracks;
- Emergency shower.

8.6.6 Minor (Running) Repairs

The inspection process may turn up defects in the various subsystems on the cars. Where possible, these defects shall be corrected in the inspection bay or minor repair area by replacement of components. As an example: an improper function in the propulsion subsystem may be repaired by replacement of a faulty electronic circuit card.

Repairs in these bays shall be limited to those which are simple and can be accomplished in a few hours so that the tracks are not tied up longer than 4 hours. Where the repair problem requires a longer period or special equipment, the repair shall be scheduled and the individual car moved to the appropriate repair track equipped with the required equipment.

8.6.7 Major Repairs and Component Change Out

Major repairs include heavy repairs such as truck repair, overhauls, renovating undercar structures, refurbishing interiors, etc. These repairs are scheduled and a computerized management information system has been established to maintain records of maintenance performed on each car. These repairs normally take an extended period of time.

8.6.7.1 Configuration of Floor and Work Space

- Floor at top-of-rail elevation;
- Covered LRV hoist equipment pits per hoist equipment manufacturer's requirements;
- Sufficient clear space beside work positions to bring a forklift;
- Portable scaffolding to reach roof equipment.

8.6.7.2 Utility Requirements

- Overhead lighting to provide 35 to 45 foot-candles at all work locations, provide skylights wherever possible;
- 230 V single phase and 480 V three phase receptacles;

- Compressed air;
- Pit and area floor drainage with oil/water separators;
- Hose bib;
- DC power for LRV auxiliary equipment;
- Steam cleaning area for special equipment.

8.6.7.3 Special Equipment

- LRV hoist equipment;
- Jib crane to remove roof equipment;
- Truck transfer and turntable;
- Monorail cranes over heavy maintenance tracks.

8.6.7.4 Design Requirements

- Should have access to wheel truing area.

8.6.8 Wheel Truing

Periodically, flat spots on wheels must be removed and the rims and flanges restored to correct profile. This task is accomplished by a wheel truing machine — an underfloor wheel lathe or milling machine with the added capability of resurfacing the brake discs.

8.6.8.1 Configuration of Floor and Work Space

- Floor at top-of-rail elevation except at machine pit;
- Two level pit per manufacturer's requirements;
- Floor grating at shallow pit (control station) level.

8.6.8.2 Utility Requirements

- Overhead lighting to provide 35 to 45 foot-candles at all work locations and 20 foot-candles for safety lighting;
- Pit lighting;
- 110/480 V receptacles;
- Compressed air;
- Pit and area floor drainage;
- Hose bib;
- Wheel truing machine utility services;
- Contact wire interlocked with machine power;

- Network connections;
- Pit and work area lighting.

8.6.8.3 Special Equipment

- Underfloor wheel truing machine;
- Chip removal system.

8.6.8.4 Design Requirements

- Should be accessible from truck shop;
- Should be on a dedicated track.

8.6.9 Vehicle Body Repairs

The amount of vehicle body work shall depend upon the accident rate and severity of accidents encountered by the fleet. Minor damage can be repaired by mechanics using replacement panels and body patches. Heavy damage repairs may be contracted out to others.

8.6.9.1 Configuration of Work Area for Minor Damage Repairs

- Floor at rail height;
- Floor area adjacent to rails shall support the use of portable jacks and car body stands.

8.6.9.2 Utility Requirements

- Compressed air;
- Overhead lighting to provide 35 to 45 foot-candles at work locations;
- Welding machine outlets with 230/480 V receptacles;
- Hose bib for shop housekeeping.

8.6.9.3 Special Equipment

- Portable jacks;
- Portable body stands;
- Portable welding machine;
- Portable acetylene/oxygen cut-off unit;
- Power tools.

8.6.9.4 Design Requirements

Should be adjacent to the crane and tool shed.

8.6.10 Vehicle Painting

Initially the requirements for painting shall depend on the type and material of the vehicle chosen, and upon the accident rate and severity of accidents. With the exception of minor hand painting, all car body painting may be done at existing SANDAG/MTS facilities.

8.6.10.1 Paint Booth

The paint booth is located in the maintenance area adjacent to the main repair area. Special ventilation, heating and lighting are required. All major painting of vehicles and large vehicle parts will be performed in this facility. Sufficient space shall be provided for a single vehicle placement and all equipment and maneuverability required to paint the entire vehicle. For LRTs catenary equipment will not be required inside the facility. A high output of heated air flowing lengthwise of the paint booth is necessary to remove paint spray. High velocity exhaust fans are required as well. Shielded fluorescent lighting shall be located continuously from floor to ceiling along the full length of the paint booth. An area directly outside the paint booth entrance shall be provided large enough to store two vehicles for painting preparation.

8.6.11 Vehicle Sanding

The sanding facility should be located in the normal flow of traffic from the main tracks to the storage tracks, or from the storage tracks to the train washer.

8.6.11.1 Configuration of Work Area

- Floor area should be at rail height;
- Area should be fully enclosed;
- Pit between tracks.

8.6.11.2 Utility Requirements

- Support sanding system requirements;
- Overhead lighting;
- 720 V DC catenary through operation;
- Area drainage with sand traps;
- Pit lighting;
- 110/230 V receptacle.

8.6.11.3 Special Equipment

- Sand receiving track and/or truck delivery road;

- Pneumatic sanding system consisting of:
 - Receiving tank – 24 ton capacity;
 - Transfer tank;
 - Elevated delivery tanks;
 - Associated piping and controls;
 - Automatic shut-off nozzle for each drop.

8.6.11.4 Design Requirements

- Should be easily accessible from storage tracks and in the normal traffic flow to the train washer and inbound inspection;
- Should be configured to sand four vehicle storage boxes in one stop.

8.6.12 Material Storage

The main provision for material storage shall be designated within the maintenance facility in close proximity to the vehicle maintenance shops. In addition, provision shall be made within the facility for material storage, either for material not suitable for exterior storage or for temporary storage of material brought in from outside.

8.6.13 Central Maintenance, Operations and Administrative Areas

Central Maintenance, Operations and Administrative Areas should be provided for the following groups: MOW, Facilities, Training Room, LRV, Operations, Security, and Revenue.

8.6.13.1 Shop Ancillary Areas

The following shop ancillary areas are required for operation of the system:

- Foreman's Office;
- Operator Reporting & Dispatch;
- Fare Inspector Reporting and Dispatch;
- Rail Operations Center;
- Operators Ready Room;
- Operators Quiet Room;
- Vending Machines & Kitchenette;
- Break Room;
- Transportation Locker Rooms & Toilets;
- General Office;
- Management Offices.

8.6.14 Building Support Facilities

Support facilities shall generally be applied to all maintenance facilities, however inclusion or exclusion of specific support facilities in regards to an individual maintenance facility shall be at the discretion of the SANDAG/MTS Engineering.

8.6.14.1 Administrative Offices

The main administrative functions of transit operations will be centralized at the Metropolitan Transit System's (MTS) main office. Other satellite offices will be provided in individual facilities as directed by the SANDAG/MTS Engineering.

8.6.14.2 Training/Conference Rooms

Provide sufficient space to accommodate a "U" shape or rows of desk configuration. Multiple power outlets with adequate power source shall be provided for presentation equipment such as computers, projectors, televisions, sound system, and monitors. Additional items shall include storage area(s), white board, screen, and cork board.

8.6.14.3 Utility Power Room

Maintenance facilities will require an independent power distribution system for all non-catenary power elements. Provision for emergency backup power shall be included.

8.6.14.4 Personnel Facilities

To include the following:

- Lunch/break rooms with counter space, sink, vending machines, and eating areas;
- Separate toilets, showers, and locker rooms for men and women;
- Classrooms and training areas;
- First aid and recovery/rest room;
- Chemical shower and eye wash.

8.6.14.5 Janitor Facilities

Provide adequate space for storage of cleaning materials and equipment.

8.6.15 Central Maintenance and Operations Area

Central maintenance and operations area is to provide essential space for direct management of Maintenance of Way and field operations. Physical space for unit supervisors and general clerical shall also be provided.

8.6.16 Central Control Area

A communications area should be provided of sufficient size to support the total system, including the radio communications control area, operations dispatch and security, with master control board or panel, radio equipment, television surveillance monitors and public address systems for yard and shops. Within this same area will be the central control equipment room which houses all communication, radio, surveillance, fiber optic, and telephone networking and processing equipment for the entire LRT system. This shall be an environmentally controlled room with an argon fire suppressant system. Detailed capabilities to be incorporated into the design of Central Control shall be in accordance with the Basis of Design Report.

8.6.17 Emergency System Requirements

8.6.17.1 Safety Systems

- Fire Alarm System;
- Door Control;
- Essential power receptacles;
- Grounding.

8.6.18 Utility Needs

- Eye wash station water and drainage;
- UPS power;
- Generator back-up power for 120 Vac essential loads;
- Essential lighting including exit signage;
- Sprinkler system water;
- Diesel fuel with day tank;
- Telephone lines;
- Electrical 12.46 KV power;
- LN gas.

8.6.19 Building Systems

- Telephone System;
- Computer network;
- HVAC;
- PA System;
- Room for expansion

8.6.20 Security

TBD